

Technical Manual PD1-C

Fieldbus: CANopen

For use with the following variants:

PD1-C281S15-E-20-2, PD1-C281S15-E-65-2, PD1-C281S15-E-OF-2, PD1-C281L15-E-20-2, PD1-C281L15-E-65-2, PD1-C281L15-E-OF-2

Contents

| | |
|---|-----------|
| 1 Introduction..... | 10 |
| 1.1 Version information..... | 10 |
| 1.2 Copyright, marking and contact..... | 10 |
| 1.3 Intended use..... | 10 |
| 1.4 Target group and qualification..... | 11 |
| 1.5 Warranty and disclaimer..... | 11 |
| 1.6 EU directives for product safety..... | 11 |
| 1.7 Other applicable regulations..... | 11 |
| 1.8 Used icons..... | 11 |
| 1.9 Emphasis in the text..... | 12 |
| 1.10 Numerical values..... | 12 |
| 1.11 Bits..... | 12 |
| 1.12 Counting direction (arrows)..... | 13 |
| 2 Safety and warning notices..... | 14 |
| 3 Technical details and pin assignment..... | 15 |
| 3.1 Environmental conditions..... | 15 |
| 3.2 Dimensioned drawings..... | 15 |
| 3.3 Electrical properties and technical data..... | 17 |
| 3.4 Overtemperature protection..... | 18 |
| 3.5 Pin assignment..... | 19 |
| 3.5.1 Connections..... | 19 |
| 3.5.2 Voltage source..... | 22 |
| 3.5.3 Permissible operating voltage..... | 23 |
| 4 Commissioning..... | 24 |
| 4.1 Communication settings..... | 25 |
| 4.1.1 CANopen..... | 25 |
| 4.2 Establishing communication..... | 25 |
| 4.2.1..... | 25 |
| 4.3 Auto setup..... | 26 |
| 4.3.1 Parameter determination..... | 26 |
| 4.3.2 Execution..... | 27 |
| 4.3.3 Parameter memory..... | 28 |
| 4.4 Test run..... | 28 |
| 4.5 Special drive modes (clock-direction and analog speed)..... | 29 |
| 4.5.1 Activation..... | 29 |
| 4.5.2 Clock-direction..... | 30 |
| 4.5.3 Analog speed..... | 30 |
| 4.5.4 Test run with 30 rpm..... | 31 |
| 5 General concepts..... | 32 |
| 5.1 Control modes..... | 32 |
| 5.1.1 General..... | 32 |
| 5.1.2 Open-Loop..... | 33 |
| 5.1.3 Closed-Loop..... | 34 |
| 5.2 CiA 402 Power State Machine..... | 40 |

| | |
|--|-----------|
| 5.2.1 State machine..... | 40 |
| 5.2.2 Behavior upon exiting the <i>Operation enabled state</i> | 41 |
| 5.3 User-defined units..... | 44 |
| 5.3.1 Units..... | 45 |
| 5.3.2 Encoder resolution..... | 46 |
| 5.3.3 Gear ratio..... | 46 |
| 5.3.4 Feed constant..... | 47 |
| 5.3.5 Calculation formulas for user units..... | 47 |
| 5.4 Limitation of the range of motion..... | 48 |
| 5.4.1 Software limit switches..... | 49 |
| 5.5 Cycle times..... | 49 |
| | |
| 6 operating modes..... | 50 |
| 6.1 Profile Position..... | 50 |
| 6.1.1 Overview..... | 50 |
| 6.1.2 Setting travel commands..... | 51 |
| 6.1.3 Loss of accuracy for relative movements..... | 55 |
| 6.1.4 Boundary conditions for a positioning move..... | 56 |
| 6.1.5 Jerk-limited mode and non-jerk-limited mode..... | 57 |
| 6.2 Velocity..... | 58 |
| 6.2.1 Description..... | 58 |
| 6.2.2 Activation..... | 58 |
| 6.2.3 Controlword..... | 58 |
| 6.2.4 Statusword..... | 58 |
| 6.2.5 Object entries..... | 58 |
| 6.3 Profile Velocity..... | 59 |
| 6.3.1 Description..... | 59 |
| 6.3.2 Activation..... | 59 |
| 6.3.3 Controlword..... | 59 |
| 6.3.4 Statusword..... | 59 |
| 6.3.5 Object entries..... | 60 |
| 6.4 Profile Torque..... | 62 |
| 6.4.1 Description..... | 62 |
| 6.4.2 Activation..... | 62 |
| 6.4.3 Controlword..... | 62 |
| 6.4.4 Statusword..... | 62 |
| 6.4.5 Object entries..... | 63 |
| 6.5 Homing..... | 64 |
| 6.5.1 Overview..... | 64 |
| 6.5.2 Homing method..... | 66 |
| 6.6 Interpolated Position Mode..... | 71 |
| 6.6.1 Overview..... | 71 |
| 6.6.2 Activation..... | 72 |
| 6.6.3 Controlword..... | 72 |
| 6.6.4 Statusword..... | 72 |
| 6.6.5 Use..... | 72 |
| 6.6.6 Setup..... | 72 |
| 6.6.7 Operation..... | 73 |
| 6.7 Cyclic Synchronous Position..... | 73 |
| 6.7.1 Overview..... | 73 |
| 6.7.2 Object entries..... | 74 |
| 6.8 Cyclic Synchronous Velocity..... | 74 |
| 6.8.1 Overview..... | 74 |
| 6.8.2 Object entries..... | 75 |
| 6.9 Cyclic Synchronous Torque..... | 75 |
| 6.9.1 Overview..... | 75 |
| 6.9.2 Object entries..... | 76 |
| 6.10 Clock-direction mode..... | 77 |

| | |
|---|------------|
| 6.10.1 Description..... | 77 |
| 6.10.2 Activation..... | 77 |
| 6.10.3 General..... | 77 |
| 6.10.4 Statusword..... | 78 |
| 6.10.5 Subtypes of the clock-direction mode..... | 78 |
| 6.11 Auto setup..... | 79 |
| 6.11.1 Description..... | 79 |
| 6.11.2 Activation..... | 79 |
| 6.11.3 Controlword..... | 79 |
| 6.11.4 Statusword..... | 79 |
| 7 Special functions..... | 80 |
| 7.1 Digital inputs and outputs..... | 80 |
| 7.1.1 Digital inputs..... | 80 |
| 7.1.2 Digital outputs..... | 83 |
| 7.2 I ² t Motor overload protection..... | 85 |
| 7.2.1 Description..... | 85 |
| 7.2.2 Object entries..... | 85 |
| 7.2.3 Activation..... | 86 |
| 7.2.4 Function of I ² t..... | 86 |
| 7.3 Saving objects..... | 87 |
| 7.3.1 General..... | 87 |
| 7.3.2 Category: Communication..... | 87 |
| 7.3.3 Category: Application..... | 88 |
| 7.3.4 Category: User..... | 90 |
| 7.3.5 Category: Movement..... | 90 |
| 7.3.6 Category: Tuning..... | 90 |
| 7.3.7 Category: CANopen..... | 90 |
| 7.3.8 Starting the save process..... | 91 |
| 7.3.9 Discarding the saved data..... | 91 |
| 7.3.10 Verifying the configuration..... | 92 |
| 7.4 Generic SPI..... | 92 |
| 8 CANopen..... | 94 |
| 8.1 General..... | 94 |
| 8.1.1 CAN message..... | 94 |
| 8.2 CANopen services..... | 94 |
| 8.2.1 Network Management (NMT)..... | 95 |
| 8.2.2 Synchronization object (SYNC)..... | 96 |
| 8.2.3 Emergency Object (EMCY)..... | 97 |
| 8.2.4 Service Data Object (SDO)..... | 98 |
| 8.2.5 Process Data Object (PDO)..... | 105 |
| 8.2.6 Boot-Up Protocol..... | 110 |
| 8.2.7 Heartbeat and Nodeguarding..... | 110 |
| 8.3 LSS protocol..... | 112 |
| 8.3.1 General..... | 112 |
| 8.3.2 LSS message..... | 112 |
| 8.3.3 LSS services..... | 112 |
| 8.3.4 Example..... | 124 |
| 9 Programming with NanoJ..... | 125 |
| 9.1 NanoJ program..... | 125 |
| 9.2 Mapping in the NanoJ program..... | 129 |
| 9.3 NanoJ functions in the NanoJ program..... | 130 |
| 9.4 Restrictions and possible problems..... | 132 |

| | |
|---|------------|
| 10 Description of the object dictionary..... | 134 |
| 10.1 Overview..... | 134 |
| 10.2 Structure of the object description..... | 134 |
| 10.3 Object description..... | 134 |
| 10.4 Value description..... | 135 |
| 10.5 Description..... | 136 |
| 1000h Device Type..... | 137 |
| 1001h Error Register..... | 138 |
| 1003h Pre-defined Error Field..... | 139 |
| 1005h COB-ID Sync..... | 143 |
| 1006h Communication Cycle Period..... | 144 |
| 1007h Synchronous Window Length..... | 144 |
| 1008h Manufacturer Device Name..... | 145 |
| 1009h Manufacturer Hardware Version..... | 145 |
| 100Ah Manufacturer Software Version..... | 146 |
| 100Ch Guard Time..... | 146 |
| 100Dh Live Time Factor..... | 147 |
| 1010h Store Parameters..... | 147 |
| 1011h Restore Default Parameters..... | 151 |
| 1014h COB-ID EMCY..... | 154 |
| 1016h Consumer Heartbeat Time..... | 155 |
| 1017h Producer Heartbeat Time..... | 156 |
| 1018h Identity Object..... | 156 |
| 1019h Synchronous Counter Overflow Value..... | 158 |
| 1020h Verify Configuration..... | 159 |
| 1029h Error Behavior..... | 160 |
| 1400h Receive PDO 1 Communication Parameter..... | 161 |
| 1401h Receive PDO 2 Communication Parameter..... | 162 |
| 1402h Receive PDO 3 Communication Parameter..... | 163 |
| 1403h Receive PDO 4 Communication Parameter..... | 164 |
| 1404h Receive PDO 5 Communication Parameter..... | 165 |
| 1405h Receive PDO 6 Communication Parameter..... | 167 |
| 1406h Receive PDO 7 Communication Parameter..... | 168 |
| 1407h Receive PDO 8 Communication Parameter..... | 169 |
| 1600h Receive PDO 1 Mapping Parameter..... | 170 |
| 1601h Receive PDO 2 Mapping Parameter..... | 172 |
| 1602h Receive PDO 3 Mapping Parameter..... | 175 |
| 1603h Receive PDO 4 Mapping Parameter..... | 177 |
| 1604h Receive PDO 5 Mapping Parameter..... | 179 |
| 1605h Receive PDO 6 Mapping Parameter..... | 181 |
| 1606h Receive PDO 7 Mapping Parameter..... | 183 |
| 1607h Receive PDO 8 Mapping Parameter..... | 186 |
| 1800h Transmit PDO 1 Communication Parameter..... | 188 |
| 1801h Transmit PDO 2 Communication Parameter..... | 190 |
| 1802h Transmit PDO 3 Communication Parameter..... | 192 |
| 1803h Transmit PDO 4 Communication Parameter..... | 194 |
| 1804h Transmit PDO 5 Communication Parameter..... | 196 |
| 1805h Transmit PDO 6 Communication Parameter..... | 198 |
| 1806h Transmit PDO 7 Communication Parameter..... | 200 |
| 1807h Transmit PDO 8 Communication Parameter..... | 203 |
| 1A00h Transmit PDO 1 Mapping Parameter..... | 205 |
| 1A01h Transmit PDO 2 Mapping Parameter..... | 207 |
| 1A02h Transmit PDO 3 Mapping Parameter..... | 210 |
| 1A03h Transmit PDO 4 Mapping Parameter..... | 212 |
| 1A04h Transmit PDO 5 Mapping Parameter..... | 215 |
| 1A05h Transmit PDO 6 Mapping Parameter..... | 217 |
| 1A06h Transmit PDO 7 Mapping Parameter..... | 220 |

| | |
|--|-----|
| 1A07h Transmit PDO 8 Mapping Parameter..... | 222 |
| 1F50h Program Data..... | 225 |
| 1F51h Program Control..... | 226 |
| 1F57h Program Status..... | 227 |
| 1F80h NMT Startup..... | 228 |
| 2005h CANopen Baudrate..... | 228 |
| 2007h CANopen Config..... | 229 |
| 2009h CANopen NodeID..... | 230 |
| 2030h Pole Pair Count..... | 231 |
| 2031h Max Motor Current..... | 231 |
| 2034h Upper Voltage Warning Level..... | 232 |
| 2035h Lower Voltage Warning Level..... | 232 |
| 2036h Open Loop Current Reduction Idle Time..... | 233 |
| 2037h Open Loop Current Reduction Value/factor..... | 233 |
| 2038h Brake Controller Timing..... | 234 |
| 2039h Motor Currents..... | 236 |
| 203Ah Homing On Block Configuration..... | 238 |
| 203Bh I2t Parameters..... | 240 |
| 203Dh Torque Window..... | 242 |
| 203Eh Torque Window Time Out..... | 243 |
| 203Fh Max Slippage Time Out..... | 243 |
| 2057h Clock Direction Multiplier..... | 244 |
| 2058h Clock Direction Divider..... | 244 |
| 205Ah Absolute Sensor Boot Value (in User Units)..... | 245 |
| 205Bh Clock Direction Or Clockwise/Counter Clockwise Mode..... | 245 |
| 2084h Bootup Delay..... | 246 |
| 2101h Fieldbus Module Availability..... | 246 |
| 2102h Fieldbus Module Control..... | 247 |
| 2103h Fieldbus Module Status..... | 249 |
| 2290h PDI Control..... | 251 |
| 2291h PDI Input..... | 251 |
| 2292h PDI Output..... | 253 |
| 2300h NanoJ Control..... | 254 |
| 2301h NanoJ Status..... | 255 |
| 2302h NanoJ Error Code..... | 256 |
| 2303h NanoJ Metadata..... | 257 |
| 230Eh Timer..... | 258 |
| 230Fh Uptime Seconds..... | 259 |
| 2310h NanoJ Input Data Selection..... | 260 |
| 2320h NanoJ Output Data Selection..... | 261 |
| 2330h NanoJ In/output Data Selection..... | 263 |
| 2400h NanoJ Inputs..... | 264 |
| 2410h NanoJ Init Parameters..... | 265 |
| 2500h NanoJ Outputs..... | 266 |
| 2600h NanoJ Debug Output..... | 267 |
| 2701h Customer Storage Area..... | 267 |
| 2800h Bootloader And Reboot Settings..... | 268 |
| 306C _h Velocity Actual Internal Value..... | 270 |
| 3202h Motor Drive Submode Select..... | 270 |
| 3203h Feedback Selection..... | 271 |
| 3204h Feedback Mapping..... | 273 |
| 3205 _h Feedback Use..... | 274 |
| 320Dh Torque Of Inertia Factor..... | 275 |
| 3212h Motor Drive Flags..... | 277 |
| 321Ah Current Controller Parameters..... | 278 |
| 321Bh Velocity Controller Parameters..... | 281 |
| 321Ch Position Controller Parameters..... | 282 |
| 321Dh Feedforward..... | 283 |
| 321Eh Voltage Limit..... | 285 |

| | |
|---|-----|
| 3220h Analog Input Digits..... | 286 |
| 323Ah User Pin Settings..... | 287 |
| 3241h Digital Input Position Capture..... | 288 |
| 3242h Digital Input Routing..... | 289 |
| 3243h Home Switch Position Capture..... | 296 |
| 324Ah Inputs..... | 298 |
| 3250h Digital Outputs Control..... | 299 |
| 3252h Digital Output Routing..... | 300 |
| 325Ah Outputs..... | 301 |
| 3273h Generic SPI Hardware Configuration..... | 302 |
| 3274h Generic SPI Mosi Data..... | 303 |
| 3275h Generic SPI Miso Data..... | 304 |
| 3320h Analog Input Values..... | 304 |
| 3321h Analog Input Offsets..... | 305 |
| 3322h Analog Input Numerators..... | 306 |
| 3323h Analog Input Denominators..... | 307 |
| 3380h Feedback Sensorless..... | 308 |
| 33A0h Feedback Incremental A/B/I 1..... | 311 |
| 3700h Deviation Error Option Code..... | 312 |
| 3701h Limit Switch Error Option Code..... | 313 |
| 4012h HW Information..... | 314 |
| 4013h HW Configuration..... | 315 |
| 4014h Operating Conditions..... | 316 |
| 4015h Special Drive Modes..... | 317 |
| 4016h Factory Setup..... | 319 |
| 4040h Drive Serial Number..... | 320 |
| 4041h Device Id..... | 320 |
| 4042h Bootloader Infos..... | 321 |
| 6007h Abort Connection Option Code..... | 322 |
| 603Fh Error Code..... | 323 |
| 6040h Controlword..... | 323 |
| 6041h Statusword..... | 324 |
| 6042h VI Target Velocity..... | 326 |
| 6043h VI Velocity Demand..... | 326 |
| 6044h VI Velocity Actual Value..... | 327 |
| 6046h VI Velocity Min Max Amount..... | 327 |
| 6048h VI Velocity Acceleration..... | 328 |
| 6049h VI Velocity Deceleration..... | 329 |
| 604Ah VI Velocity Quick Stop..... | 330 |
| 604Ch VI Dimension Factor..... | 331 |
| 605Ah Quick Stop Option Code..... | 332 |
| 605Bh Shutdown Option Code..... | 333 |
| 605Ch Disable Operation Option Code..... | 334 |
| 605Dh Halt Option Code..... | 334 |
| 605Eh Fault Reaction Option Code..... | 335 |
| 6060h Modes Of Operation..... | 336 |
| 6061h Modes Of Operation Display..... | 336 |
| 6062h Position Demand Value..... | 337 |
| 6063h Position Actual Internal Value..... | 337 |
| 6064h Position Actual Value..... | 338 |
| 6065h Following Error Window..... | 338 |
| 6066h Following Error Time Out..... | 339 |
| 6067h Position Window..... | 339 |
| 6068h Position Window Time..... | 340 |
| 606Bh Velocity Demand Value..... | 341 |
| 606Ch Velocity Actual Value..... | 341 |
| 606Dh Velocity Window..... | 341 |
| 606Eh Velocity Window Time..... | 342 |
| 606Fh Velocity Threshold..... | 343 |

| | |
|--|-----|
| 6070h Velocity Threshold Time..... | 343 |
| 6071h Target Torque..... | 344 |
| 6072h Max Torque..... | 344 |
| 6073h Max Current..... | 345 |
| 6074h Torque Demand..... | 346 |
| 6075h Motor Rated Current..... | 346 |
| 6077h Torque Actual Value..... | 346 |
| 607Ah Target Position..... | 347 |
| 607Bh Position Range Limit..... | 347 |
| 607Ch Home Offset..... | 348 |
| 607Dh Software Position Limit..... | 349 |
| 607Eh Polarity..... | 350 |
| 607Fh Max Profile Velocity..... | 351 |
| 6080h Max Motor Speed..... | 351 |
| 6081h Profile Velocity..... | 352 |
| 6082h End Velocity..... | 352 |
| 6083h Profile Acceleration..... | 353 |
| 6084h Profile Deceleration..... | 353 |
| 6085h Quick Stop Deceleration..... | 354 |
| 6086h Motion Profile Type..... | 354 |
| 6087h Torque Slope..... | 355 |
| 608Fh Position Encoder Resolution..... | 355 |
| 6090h Velocity Encoder Resolution..... | 356 |
| 6091h Gear Ratio..... | 358 |
| 6092h Feed Constant..... | 359 |
| 6096h Velocity Factor..... | 360 |
| 6097h Acceleration Factor..... | 361 |
| 6098h Homing Method..... | 362 |
| 6099h Homing Speed..... | 363 |
| 609Ah Homing Acceleration..... | 364 |
| 60A2h Jerk Factor..... | 364 |
| 60A4h Profile Jerk..... | 365 |
| 60A8h SI Unit Position..... | 367 |
| 60A9h SI Unit Velocity..... | 368 |
| 60B0h Position Offset..... | 368 |
| 60B1h Velocity Offset..... | 369 |
| 60B2h Torque Offset..... | 369 |
| 60C1h Interpolation Data Record..... | 370 |
| 60C2h Interpolation Time Period..... | 371 |
| 60C4h Interpolation Data Configuration..... | 372 |
| 60C5h Max Acceleration..... | 374 |
| 60C6h Max Deceleration..... | 374 |
| 60E4h Additional Position Actual Value..... | 375 |
| 60E5h Additional Velocity Actual Value..... | 376 |
| 60E6h Additional Position Encoder Resolution - Encoder Increments..... | 377 |
| 60E8h Additional Gear Ratio - Motor Shaft Revolutions..... | 378 |
| 60E9h Additional Feed Constant - Feed..... | 379 |
| 60EBh Additional Position Encoder Resolution - Motor Revolutions..... | 380 |
| 60EDh Additional Gear Ratio - Driving Shaft Revolutions..... | 381 |
| 60EEh Additional Feed Constant - Driving Shaft Revolutions..... | 382 |
| 60F2h Position Option Code..... | 383 |
| 60F4h Following Error Actual Value..... | 385 |
| 60F8h Max Slippage..... | 385 |
| 60FAh Control Effort..... | 386 |
| 60FCh Position Demand Internal Value..... | 386 |
| 60FDh Digital Inputs..... | 387 |
| 60FEh Digital Outputs..... | 388 |
| 60FFh Target Velocity..... | 389 |
| 6502h Supported Drive Modes..... | 389 |

6503h Drive Catalogue Number..... 390
6505h Http Drive Catalogue Address..... 391

11 Copyrights.....392

11.1 Introduction..... 392
11.2 AES..... 392
11.3 MD5..... 392
11.4 uIP..... 393
11.5 DHCP..... 393
11.6 CMSIS DSP Software Library..... 393
11.7 FatFs..... 393
11.8 Protothreads..... 394
11.9 lwIP..... 394
11.10 littlefs..... 395

1 Introduction

The *PD1-C* is a stepper motor with integrated controller. The integrated absolute encoder makes immediate operation possible in *closed loop* mode without homing.

This manual describes the functions of the controller and the available operating modes. It also shows how you can address and program the controller via the communication interface.

You can find further information on the product on us.nanotec.com.

1.1 Version information

| Manual version | Date | Changes | Firmware version | Hardware version |
|----------------|---------|---|------------------|------------------|
| 1.0.0 | 10/2023 | Edition | B1048823 | W002 |
| 1.0.1 | 11/2023 | Minor corrections | B1048823 | W002 |
| 1.0.2 | 12/2023 | <u>Pin arrangement</u> for IP65 variants corrected. | B1048823 | W002 |
| 1.1.0 | 07/2024 | New Firmware: <i>Slow Speed Mode</i> currently not supported. Minor corrections. | FIR-v2425 | W002 |

1.2 Copyright, marking and contact

© 2013 – 2023 Nanotec Electronic GmbH & Co. KG. All rights reserved.



Nanotec Electronic GmbH & Co. KG

Kapellenstraße 6

85622 Feldkirchen

Germany

Phone: +49 89 900 686-0

Fax: +49 (89) 900 686-50

us.nanotec.com

1.3 Intended use

The *PD1-C* motor with integrated controller is used as a component of drive systems in a range of industrial applications.

Use the product as intended within the limits defined in the technical data (in particular, see) and the approved Environmental conditions.

Under no circumstances may this Nanotec product be integrated as a safety component in a product or system. All products containing a component manufactured by Nanotec must, upon delivery to the end user, be provided with corresponding warning notices including instructions for safe use and safe operation. All warning notices provided by Nanotec must be passed on directly to the end user.

1.4 Target group and qualification

The product and this documentation are directed towards technically trained specialists staff such as:

- Development engineers
- Plant engineers
- Installers/service personnel
- Application engineers

Only specialists may install, program and commission the product. Specialist staff are persons who

- have appropriate training and experience in working with motors and their controller,
- are familiar with and understand the content of this technical manual,
- know the applicable regulations.

1.5 Warranty and disclaimer

Nanotec shall not be liable for damage and malfunctions attributable to installation errors, failure to observe this document or improper repair. The plant engineer, operating company and user shall be responsible for the selection, operation and use of our products. Nanotec shall not take responsibility for integration of the product in the end system. The general terms and conditions listed at www.nanotec.de shall apply. **Note:** Conversion/modification of the product is prohibited.

1.6 EU directives for product safety

The following EU directives were observed:

- RoHS directive (2011/65/EU, 2015/863/EU)
- EMC directive (2014/30/EU)

NOTICE



For product variants without closed housing (*PD1-C...-OF...*), no EMC tests were performed. Perform a risk assessment for the entire machine/system to identify possible risks due to electromagnetic interference and initiate suitable protection measures if necessary.

1.7 Other applicable regulations

In addition to this technical manual, the following regulations are to be observed:

- Accident-prevention regulations
- Local regulations on occupational safety

1.8 Used icons

All notices are in the same format. The degree of the hazard is divided into the following classes.

CAUTION!



The CAUTION notice indicates a possibly dangerous situation.

Failure to observe the notice **may** result in moderately severe injuries.

- ▶ Describes how you can avoid the dangerous situation.

NOTICE



Indicates a possible incorrect operation of the product.

Failure to observe the notice may result in damage to this or other products.

► Describes how you can avoid the incorrect operation.



TIP

Shows a tip for the application or task.

1.9 Emphasis in the text

The following conventions are used in the document:

Underlined text indicates cross references and hyperlinks:

- The following bits in object `6041h` (statusword) have a special function:
- A list of available system calls can be found in chapter NanoJ functions in the NanoJ program.

Text set in *italics* marks named objects:

- Read the *installation manual*.
- Use the *Plug & Drive Studio* software to perform the auto setup.
- For software: You can find the corresponding information in the *Operation* tab.
- For hardware: Use the *ON/OFF* switch to switch the device on.

A text set in *Courier* marks a code section or programming command:

- The line with the `od_write(0x6040, 0x00, 5);` command has no effect.
- The NMT message is structured as follows: `000 | 81 2A`

A text in "quotation marks" marks user input:

- Start the NanoJ program by writing object `2300h`, bit 0 = "1".
- If a holding torque is already needed in this state, the value "1" must be written in `3212h:01h`.

1.10 Numerical values

Numerical values are generally specified in decimal notation. The use of hexadecimal notation is indicated by a subscript *h* at the end of the number.

The objects in the object dictionary are written with index and subindex as follows: `<Index>:<Subindex>`

Both the index as well as the subindex are specified in hexadecimal notation. If no subindex is listed, the subindex is `00h`.

Example: Subindex 5 of object `1003h` is addressed with `1003h:05h`, subindex 00 of object `6040h` with `6040h`.

1.11 Bits

The numbering of individual bits in an object always begins with the LSB (bit number 0). See the following figure, which uses data type *UNSIGNED8* as an example.

| | | | | | | | | | |
|------------|-----|---|---|---|---|---|---|-----|---|
| | MSB | | | | | | | LSB | |
| Bit Number | 7 | 6 | 5 | 4 | 3 | 2 | 1 | 0 | |
| Bits | 0 | 1 | 0 | 1 | 0 | 1 | 0 | 1 | ≙ 55 _{hex} ≙ 85 _{dec} |

1.12 Counting direction (arrows)

In figures, the counting direction is always in the direction of an arrow. Objects 60C5_h and 60C6_h depicted as examples in the following figure are both specified as positive.

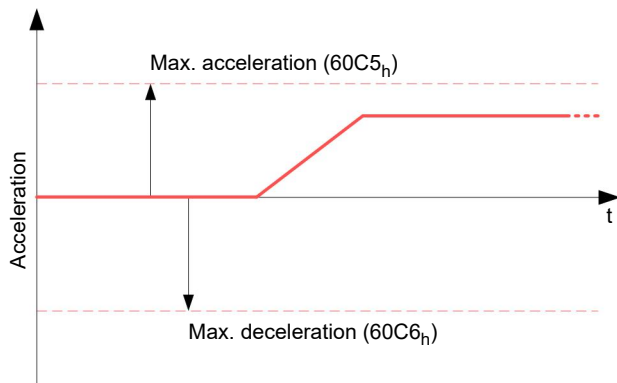

2 Safety and warning notices

CAUTION!

Risk of burning from hot surfaces!



The motor can become very hot during operation. If touched, this could result in burns.

- ▶ During use, make certain that the environmental conditions are ensured and that operation takes place within the limits defined by the technical data.
- ▶ Install the motor in such a way that heat dissipation and passive cooling are possible.
- ▶ After switching off, wait until all components have cooled before you touch them.

NOTICE

Damage to the controller!



Changing the wiring during operation may damage the controller.

- ▶ Only change the wiring in a de-energized state. After switching off, wait until the capacitors have discharged.

NOTICE

Damage to the controller due to excitation voltage of the motor!



Voltage peaks during operation may damage the controller.

- ▶ Install suitable circuits (e.g., charging capacitor) that reduce voltage peaks.

NOTICE

Damage to the electronics through improper handling of ESD-sensitive components!



The device contains components that are sensitive to electrostatic discharge. Improper handling can damage the device.

- ▶ Observe the basic principles of ESD protection when handling the device.

NOTICE

Damage to the electronics if the supply voltage is connected with reversed polarity!



- ▶ Install a line protection device (fuse) in the supply line.

3 Technical details and pin assignment

3.1 Environmental conditions

| Environmental condition | Value |
|--|---|
| Protection class | <ul style="list-style-type: none"> ■ PD1-C...-...-OF-...: No IP protection ■ PD1-C...-...-20-...: IP20 ■ PD1-C...-...-65-...: IP65 (except for shaft output) |
| Ambient temperature (operation) | -10 ... +40°C |
| Ambient temperature (storage and transport) | -25 ... +85°C |
| Relative humidity (operation), non-condensing | 0 ... 85% |
| Relative humidity (storage and transport), non-condensing | 0 ... 85% |
| Absolute humidity (storage and transport), non-condensing | 30 g/m ³ |
| Max. altitude of site above sea level (without drop in performance in operation) | 1500 m |
| Max. altitude of site above sea level (storage and transport) | 3000 m |

3.2 Dimensioned drawings

PD1-C281S15-E-OF-...

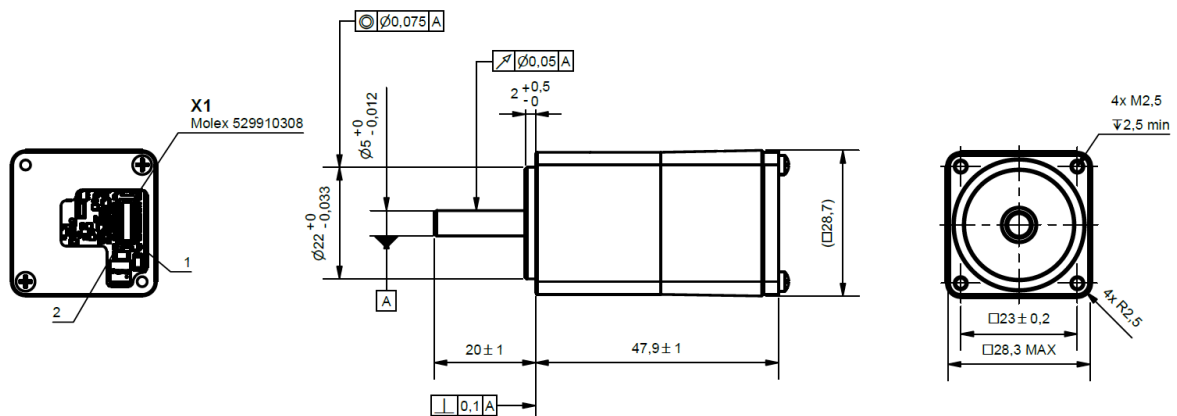

PD1-C281S15-E-20-...

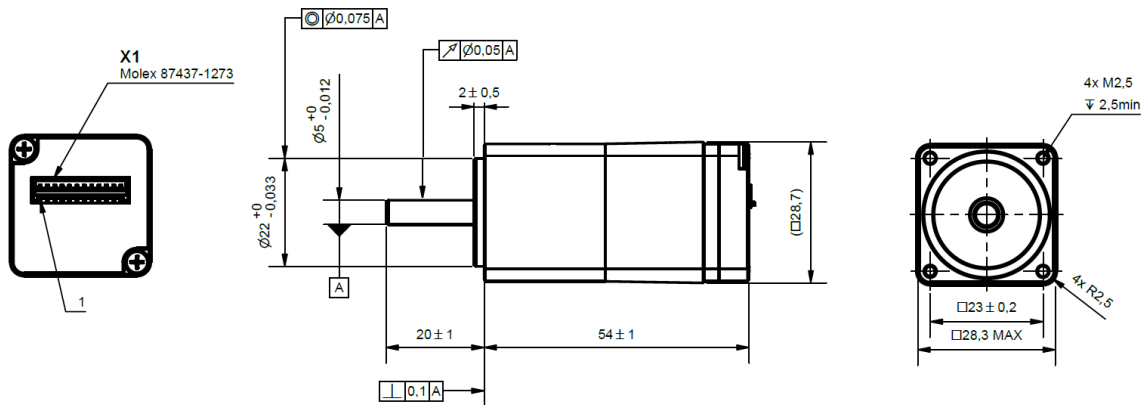

PD1-C281S15-E-65-...

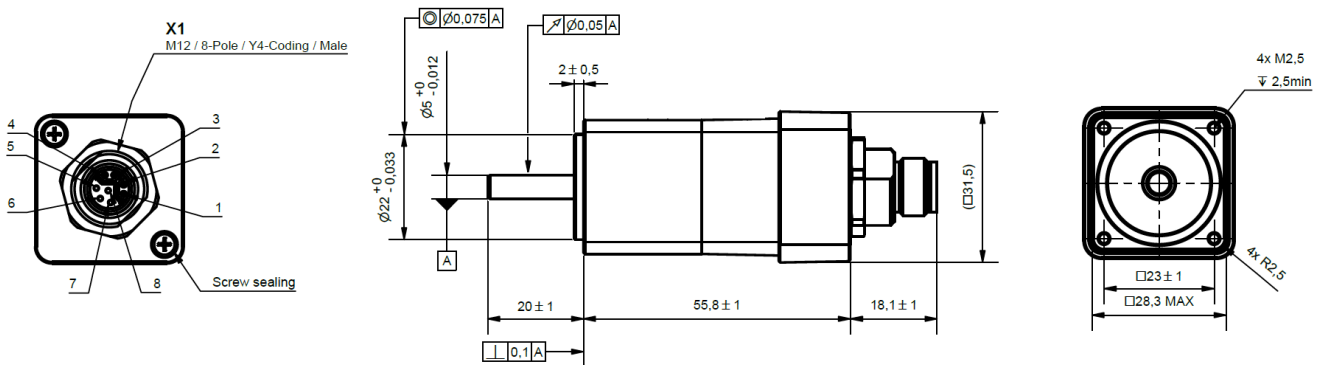

PD1-C281L15-E-OF-...

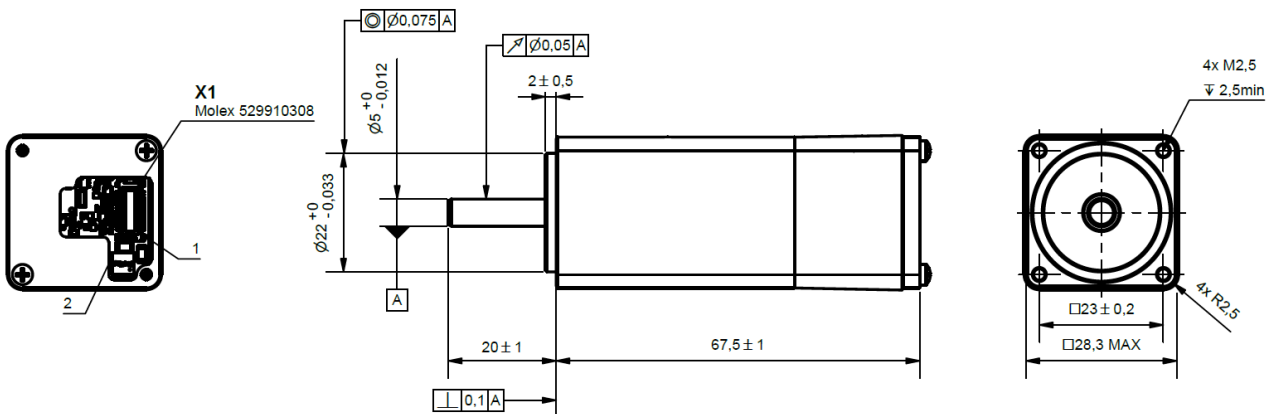

PD1-C281L15-E-20-...

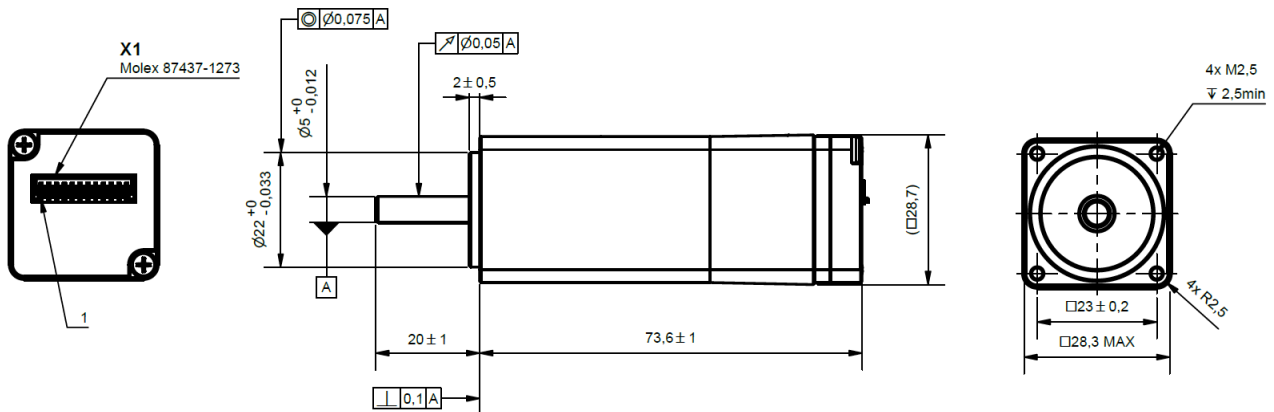

PD1-C281L15-E-65-...

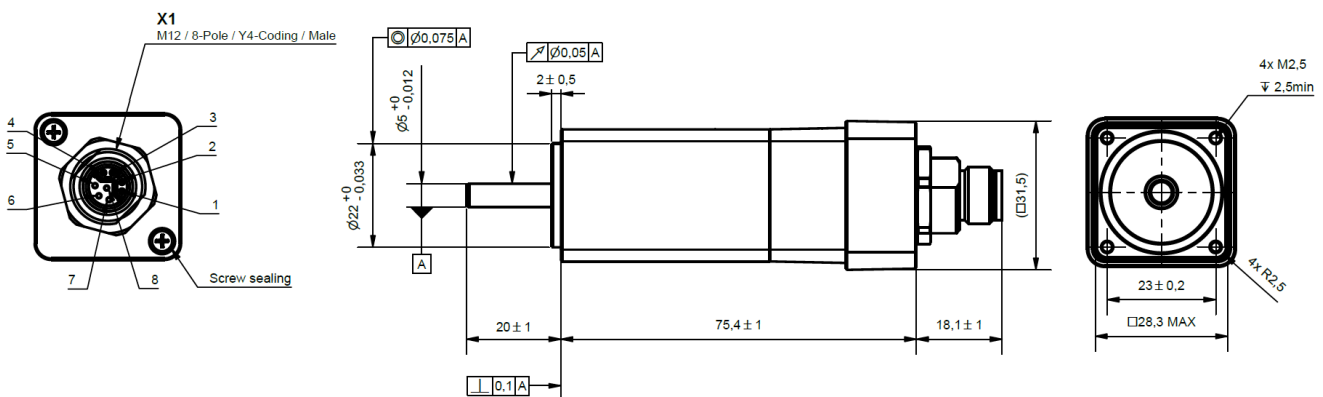

3.3 Electrical properties and technical data

| Property | Description / value |
|-------------------|---|
| Operating voltage | 12 V DC to 30 V DC |
| Rated current | 1.5 A _{rms} |
| Peak current | 3 A _{rms} for max. 3 seconds |
| | Note: To avoid voltage drops at peak current that would cause an under-voltage error at voltages near the lower limit (below 15 V), connect a capacitor of at least 4700 µF / 50 V (approx. 1000 µF per ampere motor current) parallel to the supply. |
| Operating modes | <i>Profile Position Mode, Profile Velocity Mode, Profile Torque Mode, Velocity Mode, Homing Mode, Interpolated Position Mode, Cyclic Sync Position Mode, Cyclic Sync Velocity Mode, Cyclic Synchronous Torque Mode, Clock-Direction Mode (not available for the IP65 variant)</i> |

| Property | Description / value |
|---------------------------------|---|
| Set value setting / programming | <i>Clock-direction, analog, NanoJ program</i> |
| Interfaces | CANopen |
| Inputs | <ul style="list-style-type: none"> ■ <i>PD1-C...-...-OF-...: 3 digital (5/24 V switchable), 1 analog (12-bit resolution, 0 - 24 V, can also be read out as fourth digital input)</i> ■ <i>PD1-C...-...-20-...: 3 digital (5/24 V switchable), 1 analog (12-bit resolution, 0 - 24 V, can also be read out as fourth digital input)</i> ■ <i>PD1-C...-...-65-...: 1 digital (5/24 V switchable)</i> |
| Outputs | <ul style="list-style-type: none"> ■ <i>PD1-C...-...-OF-...: 2 digital, push-pull (5/UB V switchable)</i> ■ <i>PD1-C...-...-20-...: 2 digital, push-pull (5/UB V switchable)</i> ■ <i>PD1-C...-...-65-...: 1 digital, push-pull (5/UB V switchable)</i> |
| Protection circuit | <p>Overvoltage and undervoltage protection</p> <p>Overtemperature protection (> 80° Celsius on the power board)</p> <p>Polarity reversal protection: In the event of a polarity reversal, a short-circuit will occur between supply voltage and GND over a power diode; a line protection device (fuse) is therefore necessary in the supply line. The values of the fuse are dependent on the application and must be dimensioned</p> <ul style="list-style-type: none"> ■ greater than the maximum current consumption of the controller, ■ less than the maximum current of the voltage supply. <p>If the fuse value is very close to the maximum current consumption of the controller, a medium / slow tripping characteristics should be used.</p> |

3.4 Overtemperature protection

Above a temperature of approx. 80 °C on the power board the power part of the controller switches off and the error bit is set (see objects `1001h` and `1003h`). After cooling down and confirming the error (see [table for the controlword](#), "Fault reset"), the controller again functions normally.

Temperature-dependent power reduction

The following diagram shows the permissible continuous current as a function of the ambient temperature:

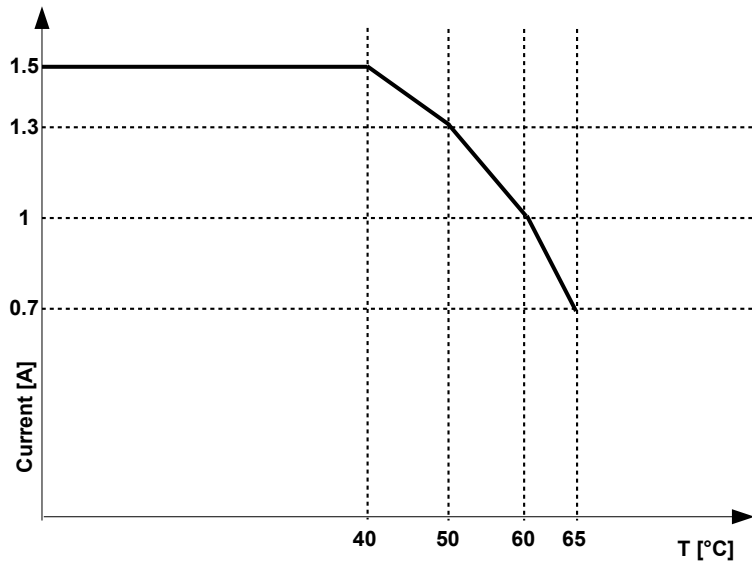

NOTICE



Aside from the motor, the exact temperature behavior is also dependent on the flange connection and the heat transfer there as well as on the convection in the application. For this reason, Nanotec recommends always performing an endurance test in the actual environment for applications in which current level and ambient temperature pose a problem.

Make sure that heat dissipation via the mounting surface and passive cooling or active ventilation are possible, so that the maximal ambient temperature stays within the limits.

3.5 Pin assignment



NOTICE

All pins with designation *GND* are internally connected.

3.5.1 Connections



NOTICE

You must terminate the CAN network with a termination resistor of 120 Ohm on both line ends..

PD1-...-OF-...

- Type: Molex 52991-0308

Pins 1 and 2 are marked in the following figure.

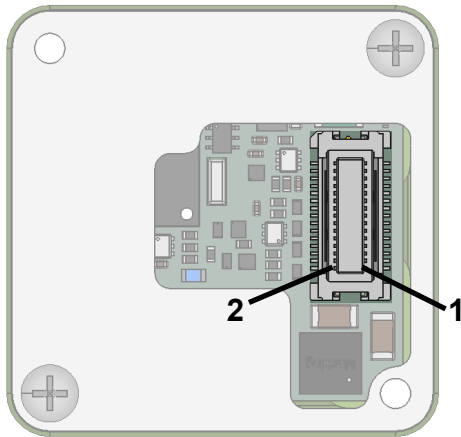

| Pin(s) | Function | Note |
|----------------|--------------------------------|---|
| 2, 4, 6, 8, 10 | GND | |
| 1, 3, 5, 7, 9 | +UB | 12-30 V DC Note: You must connect all 5 pins to the supply voltage. |
| 11 | Digital input 1 | 5/24 V switchable with $323A_h$, max. 1 MHz, clock input in clock-direction mode |
| 12 | Digital input 2 | 5/24 V switchable with $323A_h$, max. 1 MHz, direction input in clock-direction mode |
| 13 | Digital input 3 | 5/24 V switchable with $323A_h$ |
| 14 | Analog input / digital input 4 | 12 bit, 0-30 V |
| 15 | Digital output 1 | Push-pull, 5/+UB V switchable with $323A_h$, max. 50 mA |
| 16 | CAN_H | |
| 17 | Digital output 2 | Push-pull, 5/+UB V switchable with $323A_h$, max. 50 mA |
| 18 | CAN_L | |
| 19 | reserved | do not connect |
| 20 | reserved | do not connect |
| 21 | reserved | do not connect |
| 22 | reserved | do not connect |
| 23 | reserved | do not connect |
| 24 | reserved | do not connect |
| 25 | reserved | do not connect |
| 26 | USER_SPI_NSS | Chip Select pin of the interface <u>Generic SPI</u> |
| 27 | USER_SPI_MISO | MISO pin of the interface <u>Generic SPI</u> |
| 28 | USER_SPI_SCK | Clock pin of the interface <u>Generic SPI</u> |
| 29 | USER_SPI_MOSI | MOSI pin of the interface <u>Generic SPI</u> |
| 30 | +3.3V | Output voltage, max. 100 mA |

PD1-...-20-...

- Type: Molex 87437-1273

In the following figure, pin 1 is marked.

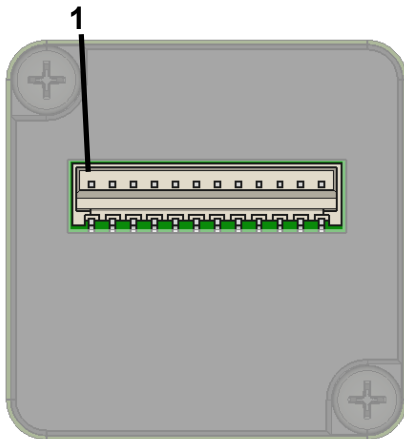

| Pin | Function | Note |
|-----|--------------------------------|---|
| 1 | Digital output 1 | Push-pull, 5/+UB V switchable with $323A_h$, max. 50 mA |
| 2 | Digital output 2 | Push-pull, 5/+UB V switchable with $323A_h$, max. 50 mA |
| 3 | Digital input 1 | 5/24 V switchable with $323A_h$, max. 1 MHz, clock input in clock-direction mode |
| 4 | Digital input 2 | 5/24 V switchable with $323A_h$, max. 1 MHz, direction input in clock-direction mode |
| 5 | Digital input 3 | 5/24 V switchable with $323A_h$ |
| 6 | Analog input / digital input 4 | 12 bit, 0-30 V |
| 7 | CAN_H | |
| 8 | CAN_L | |
| 9 | reserved | do not connect |
| 10 | reserved | do not connect |
| 11 | +UB | 12-30 V DC |
| 12 | GND | |

PD1-...-65-...

- Type: M12, 8-pin, Y4-coded, male

The pin numbers are marked in the following figure.

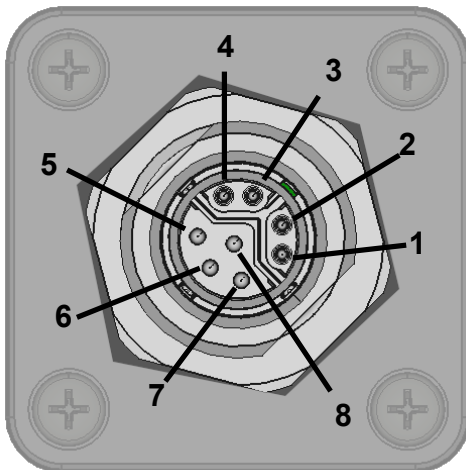

| Pin | Function | Note |
|-----|------------------|---|
| 1 | CAN_H | CAN_H IN |
| 2 | CAN_L | CAN_L IN |
| 3 | CAN_H | CAN_H OUT |
| 4 | CAN_L | CAN_L OUT |
| 5 | Digital input 1 | 5/24 V switchable with <u>323A_h</u> |
| 6 | Digital output 1 | Push-pull, 5/+UB V switchable with <u>323A_h</u> , max. 50 mA |
| 7 | +UB | 12-30 V DC |
| 8 | GND | |

Switching thresholds

The following switching thresholds apply for the digital inputs and the analog input (if available):

| Max. voltage | Switching thresholds | |
|--------------|----------------------|---------|
| | On | Off |
| 5 V | > 2 V | < 0,8 V |
| 24 V | > 15 V | < 5 V |

3.5.2 Voltage source

The operating or supply voltage supplies a battery, a transformer with rectification and filtering, or a switching power supply.

NOTICE



EMC: For a DC power supply line longer than 30 m or when using the motor on a DC bus, additional interference-suppression and protection measures are necessary.

- ▶ An EMI filter is to be inserted in the DC supply line as close as possible to the controller/motor.
- ▶ Long data or supply lines are to be routed through ferrites.

3.5.3 Permissible operating voltage

The maximum operating voltage is 30 V. If the input voltage of the controller exceeds the threshold value set in 2034_n, the motor is switched off and an error triggered. The minimum operating voltage is 12 V DC. If the input voltage of the controller falls below the threshold value set in 2035_n, the motor is switched off and an error triggered.

A charging capacitor of at least 4700 µF / 50 V (approx. 1000 µF per ampere rated current) must be connected in parallel to the supply voltage to avoid exceeding the permissible operating voltage (e. g., during braking).

NOTICE



Damage to the controller and/or its power supply due to excitation voltage of the motor!

Voltage peaks during operation may damage the controller and possibly its power supply.

- ▶ Install suitable circuits (e.g., charging capacitor) that reduce voltage peaks.
 - ▶ Use a power supply with protection circuit to protect against overvoltage.
-

4 Commissioning

Described in this chapter is how you establish communication with the controller and set the necessary parameters to make the motor ready for operation.

The controller also offers you the possibility to switch *special drive modes* on/off via object 4015_h. You can thereby control the motor directly via the inputs (analog input/clock-direction). See chapter [Special drive modes \(clock-direction and analog speed\)](#) for details.

Observe the following notes:

CAUTION!



Moving parts can cause hand injuries.

If you touch moving parts during running operation, hand injuries may result.

- ▶ Do not reach for moving parts during operation. After switching off, wait until all movements have ended.

CAUTION!



In free-standing operation, motor movements are uncontrolled and can cause injuries.

If the motor is unsecured, it can, e. g., fall down. Foot injuries or damage to the motor could occur.

- ▶ If you operate the motor free-standing, observe the motor, switch it off immediately in the event of danger and make certain that the motor cannot fall down.

CAUTION!



Moving parts can catch hair and loose clothing.

During running operation, moving parts can catch hair or loose clothing, which may lead to injuries.

- ▶ If you have long hair, wear a hairnet or take other suitable protective measures when near moving parts. Do not work with loose clothing or ties near moving parts.

CAUTION!



Risk of overheating or fire if there is insufficient cooling!

If cooling is insufficient or if the ambient temperature is too high, there is a risk of overheating or fire.

- ▶ During use, make certain that the cooling and environmental conditions are ensured.

NOTICE

EMC: Current-carrying cables – particularly around supply cables – produce electromagnetic alternating fields. These can interfere with the motor and other devices.

Suitable measures may be:



- ▶ Use shielded cables and earth the cable shielding on both ends over a short distance.
- ▶ Keep power supply cables as short as possible.
- ▶ Use cables with cores in twisted pairs.
- ▶ Earth motor housing with large contact area over a short distance.
- ▶ Lay supply and control cables separately.

4.1 Communication settings

4.1.1 CANopen

Described in the following chapters is how you can change the communication settings.

The controller is configured per default for node-ID 127 and a baud rate of 1 Mbaud.

4.1.1.1 Setting node-ID and baud rate

In the default setting, the controller starts with a node-ID of 127. If a different node-ID is needed, the new value of the node-ID is entered in object 2009_h.

In the default setting, the controller starts with a baud rate of 1 MBd. The baud rate is entered in object 2005_h. The value for the corresponding baud rate can be found in the following table.

| | Value | | Baud rate in kBd |
|-----|-------|------|------------------|
| | dec | hex | |
| 129 | 81 | 10 | |
| 130 | 82 | 20 | |
| 131 | 83 | 50 | |
| 132 | 84 | 125 | |
| 133 | 85 | 250 | |
| 134 | 86 | 500 | |
| 136 | 88 | 1000 | |

You must save the changes by writing value "65766173_h" in object 1010_h:0A_h. The changes are not taken over until after the controller has been restarted.

4.2 Establishing communication

4.2.1

1. Connect the CANopen master to the controller via the CAN_L, CAN_H cables. Check the connection of your CAN-GND and that the necessary is present between CAN_H and CAN_L.
2. Supply the controller with voltage.
3. Change the configuration values if necessary, see configuration .
4. To test the interface, send bytes 40 41 60 00 00 00 00 00 to the controller.
 Statusword (6041_h) was read; you receive this response: 4B 41 60 00 XX XX 00 00.

4.3 Auto setup

To determine a number of parameters related to the motor and the connected sensors (encoders/Hall sensors), you must perform an auto setup.

TIP



As long as the motor connected to the controller or the sensors for feedback (encoders/Hall sensors) are not changed, auto setup is only to be performed once during initial commissioning.

NOTICE



Note the following prerequisites for performing the auto setup:

- ▶ The motor must be load-free.
- ▶ The motor must not be touched.
- ▶ The motor must be able to turn freely in any direction.
- ▶ No NanoJ programs may be running (object 2300_h:00_h bit 0 = "0").

TIP



Execution of the auto setup requires a relatively large amount of processor computing power. During the auto setup, this may result in fieldbuses not being operated in a timely manner.

4.3.1 Parameter determination

Auto setup determines various parameters of the connected motor and of the present sensors by means of multiple test runs and measurement runs. To a certain extent, the type and number of parameters are dependent on the respective motor configuration.

| Parameter | All motors independent of the configuration |
|--|---|
| Motor type (stepper motor or BLDC motor) | ✓ |
| Winding resistance | ✓ |
| Winding inductance | ✓ |
| Interlinking flux | ✓ |

NOTICE



It is not possible to determine the interlinking flux on motors whose windings have widely differing inductances. These motors are, therefore, not suitable for sensorless *closed-loop* operation.

| Parameter | Motor without encoder | Motor with encoder and index | Motor with encoder without index |
|--|-----------------------|------------------------------|----------------------------------|
| Encoder resolution | - | ✓ | --- |
| Alignment (shifting of the electrical zero to the index) | - | ✓ | --- |

| Parameter | Motor without Hall sensor | Motor with Hall sensor |
|------------------|---------------------------|------------------------|
| Hall transitions | - | ✓ |

4.3.2 Execution

- To preselect the *auto setup* operating mode, enter the value "-2" ("FE_h") in object 6060_h:00_h. The *power state machine* must now switch to the *Operation enabled* state, see [CiA 402 Power State Machine](#).
- Start *auto setup* by setting bit 4 *OMS* in object 6040_h:00_h (controlword).

While the auto setup is running, the following tests and measurements are performed in succession:

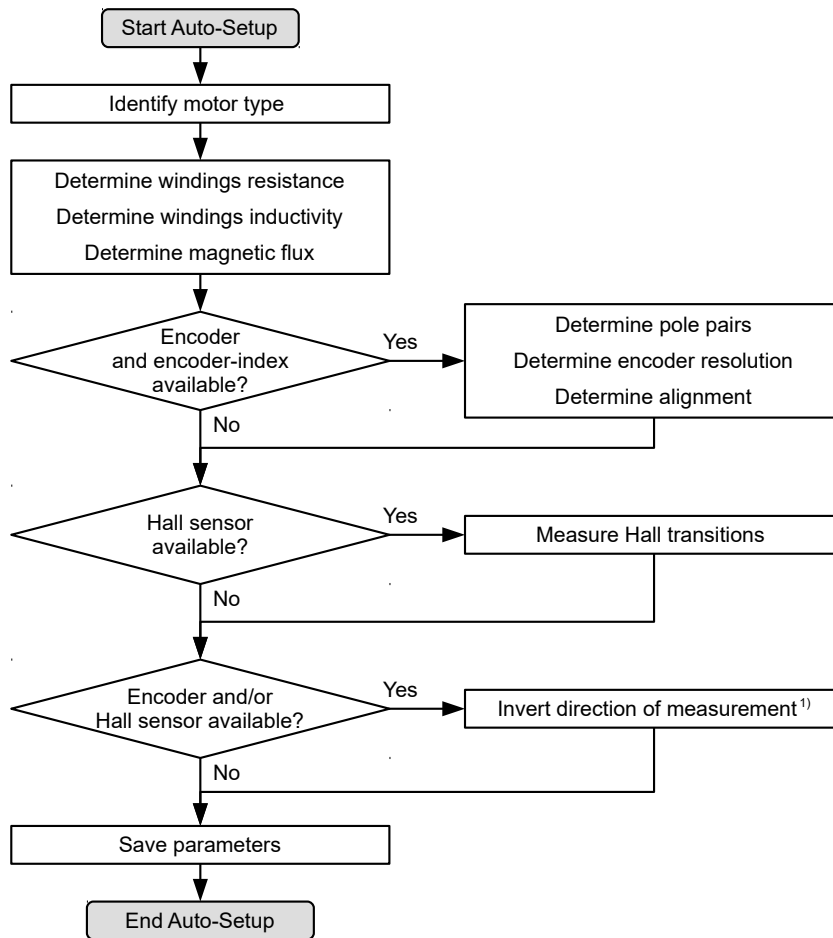

1) To determine the values, the direction of the measurement method is reversed and edge detection re-evaluated.

Value 1 in bit 12 *OMS* in object 6041_h:00_h (statusword) indicates that the auto setup was completely executed and ended. In addition, bit 10 *TARG* in object 6041_h:00_h can be used to query whether (= "1") or not (= "0") an encoder index was found.

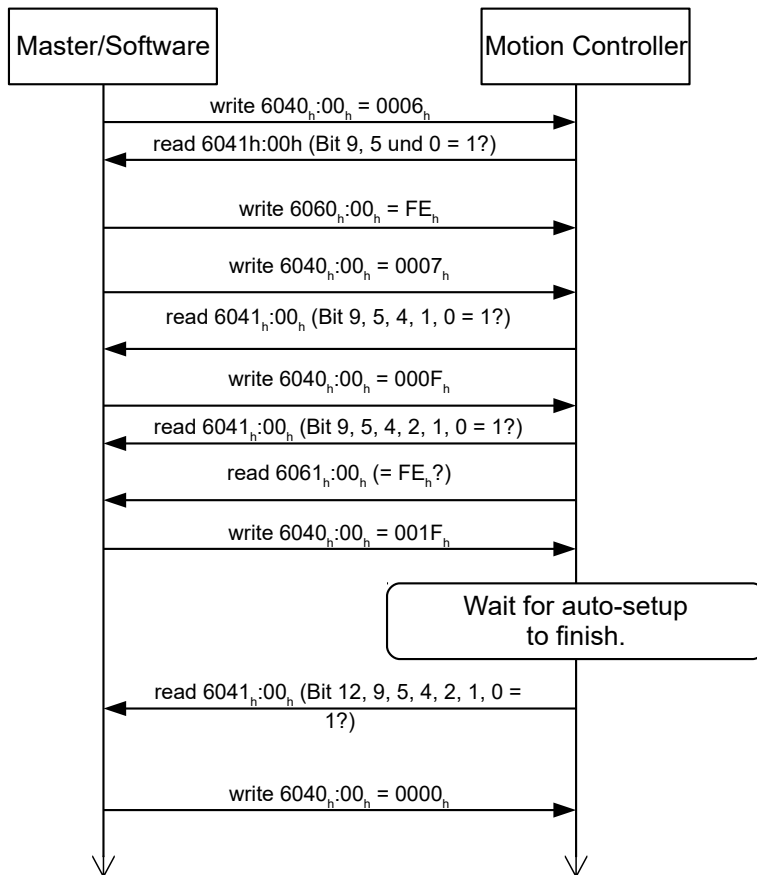

4.3.3 Parameter memory

After a successful *auto setup*, the determined parameter values are automatically taken over into the corresponding objects and stored with the storage mechanism, see [Saving objects](#) and [1010h Store Parameters](#). Categories *Drive* 1010_h:05_h and *Tuning* 1010_h:06_h are used.

CAUTION!



Uncontrolled motor movements!

After the auto setup, the internal coordinate system is no longer valid. Unforeseen reactions can result.

- ▶ Restart the device after an auto setup. Homing alone does not suffice.

4.4 Test run

After configuring and the auto setup, a test run can be performed. As an example, the *Velocity* operating mode is used.

The values are transferred from your *CANopen master* to the controller. After every transfer, the *master* should use the status objects of the controller to ensure successful parameterization.

1. Select the *Velocity* mode by setting object 6060_h (Modes Of Operation) to the value "2".
2. Write the desired speed in 6042_h.
3. Switch the *power state machine* to the *Operation enabled* state, see [CiA 402 Power State Machine](#).

The following sequence starts *Velocity* mode; the motor turns at 200 rpm.

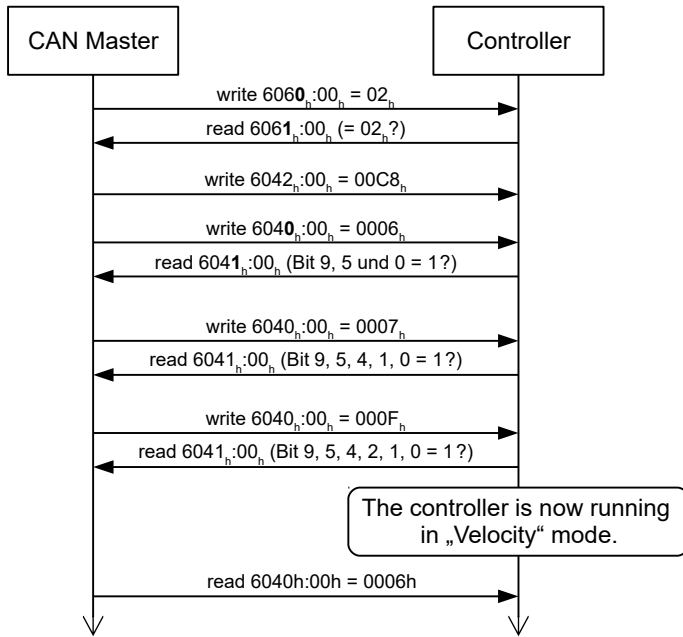

4. To stop the motor, set controlword (6040_h) to "6".

4.5 Special drive modes (clock-direction and analog speed)

NOTICE



These modes are not available for the IP65 variant.

You have the possibility to control the motor directly via the clock and direction input or the analog input by activating the *special drive modes*. These include:

- Clock-direction
- Analog speed
- Test run with 30 rpm

You can also determine the control mode – *open-loop* or *closed-loop*.

Digital input 3 serves here as an enable (see Connections).

NOTICE



After activating the *special drive modes*, the state of the CiA 402 Power State Machine is controlled only via a digital input (enable). State changes that are requested in object 6040_h (controlword) have no effect.

4.5.1 Activation

To activate the *special drive modes*, you must enter the value "2" in 4015_h:01_h. In 4015_h:02_h, set the mode by writing a value between "00"_h and "0F"_h.

The following table lists all possible modes and their value for 4015:02_h:

| Value | Mode |
|---|-------------|
| 00 _h /01 _h <u>Clock-direction</u> - | - Open-Loop |

| Value | | Mode | | |
|----------------------------------|----------------------------|---------------------------------|--|-------------|
| 02 _h | Clock-direction (test run) | Test run with 30 rpm | Clockwise direction of rotation | Open-Loop |
| 03 _h | Clock-direction (test run) | Test run with 30 rpm | Counterclockwise direction of rotation | Open-Loop |
| 04 _h | <u>Analog speed</u> | Direction via "Direction" input | <u>Maximum speed</u> 1000 rpm | Open-Loop |
| 05 _h | <u>Analog speed</u> | Direction via "Direction" input | <u>Maximum speed</u> 100 rpm | Open-Loop |
| 06 _h | <u>Analog speed</u> | Offset 5 V (joystick mode) | <u>Maximum speed</u> 1000 rpm | Open-Loop |
| 07 _h | <u>Analog speed</u> | Offset 5 V (joystick mode) | <u>Maximum speed</u> 100 rpm | Open-Loop |
| 08 _h /09 _h | <u>Clock-direction</u> | - | - | Closed-Loop |
| 0A _h | Clock-direction (test run) | Test run with 30 rpm | Clockwise direction of rotation | Closed-Loop |
| 0B _h | Clock-direction (test run) | Test run with 30 rpm | Counterclockwise direction of rotation | Closed-Loop |
| 0C _h | <u>Analog speed</u> | Direction via "Direction" input | <u>Maximum speed</u> 1000 rpm | Closed-Loop |
| 0D _h | <u>Analog speed</u> | Direction via "Direction" input | <u>Maximum speed</u> 100 rpm | Closed-Loop |
| 0E _h | <u>Analog speed</u> | Offset 5 V (joystick mode) | <u>Maximum speed</u> 1000 rpm | Closed-Loop |
| 0F _h | <u>Analog speed</u> | Offset 5 V (joystick mode) | <u>Maximum speed</u> 100 rpm | Closed-Loop |

You must save object 4015_h (*application category*) (see chapter [Saving objects](#)); the changes do not take effect until after the controller is restarted.

4.5.2 Clock-direction

The controller internally sets the operating mode to clock-direction. You must connect the *enable*, *clock* and *direction* inputs (see chapter [Connections](#)).

4.5.3 Analog speed

The controller internally sets the operating mode to Velocity. To preset the speed, the voltage on the analog input is used and the corresponding target speed is written in 6042_h.

4.5.3.1 Maximum speed

The maximum speed can be changed between 100 rpm and 1000 rpm; the controller automatically adapts the scaling in 604_h here.

NOTICE



If you would like to change to a different mode afterwards, you must adapt or reset the scaling in 604C_h if necessary.

If a different speed is necessary, it can be set using the scaling factor for the speed (object 604C_h) or the analog value (see [Analog inputs](#)).

4.5.3.2 Computation of the analog voltage

There are two modes for calculating the analog input voltage.

Normal mode

You must connect the *enable*, *direction* and *analog inputs* (see chapter [Connections](#)). The maximum analog voltage corresponds to the maximum speed. The direction is preset here via the direction input. If there is no signal at the direction input, the motor turns clockwise (when looking at the drive shaft). There is a dead zone from 0 V to 20 mV in which the motor does not move.

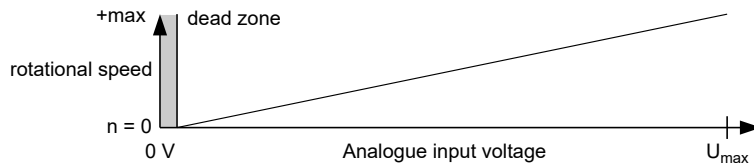

Joystick mode

You must connect the *release input* and the *analog input* (see chapter [Connections](#)). The half of the maximum analog voltage corresponds to the speed 0; the controller automatically adapts the offset in [3321_h](#) here.

NOTICE



If you would like to change to a different mode afterwards, you must adapt or [reset](#) the offset in [3321_h](#) if necessary.

If the voltage drops below half, the speed increases in the negative direction. If the speed rises above half, the speed increases likewise in the positive direction. The dead zone here extends from $U_{\max}/2 \pm 20$ mV.

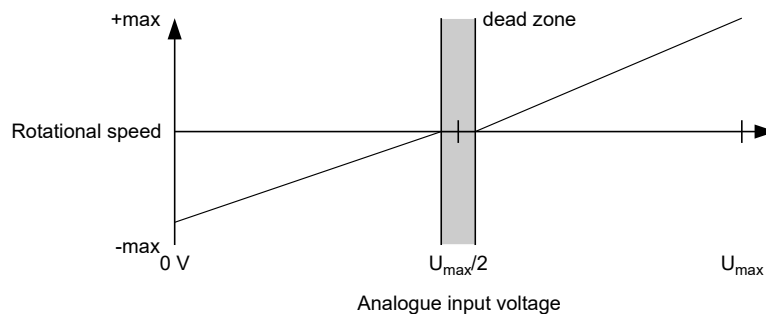

4.5.4 Test run with 30 rpm

The motor rotates at 30 rpm if the *enable input* is set.

5 General concepts

5.1 Control modes

5.1.1 General

The control mode of systems without feedback is called *open-loop*, the mode with feedback is called *closed-loop*. In the *closed-loop* control mode, it is initially irrelevant whether the fed back signals come from the motor itself or from the influenced process.

For controllers with feedback, the measured control variable (actual value) is constantly compared with a set point (set value). In the event of deviations between these values, the controller readjusts according to the specified control parameters.

Pure controllers, on the other hand, have no feedback for the value that is to be regulated. The set point (set value) is only specified.

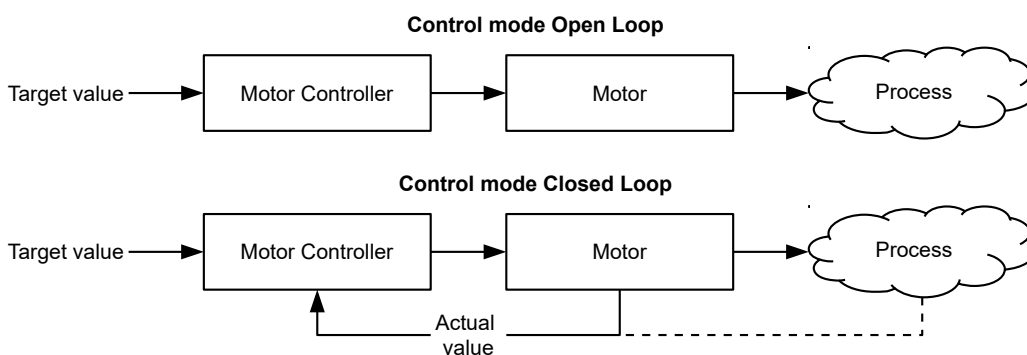

In addition to the physical feedback systems (e.g., via encoders or Hall sensors), model-based feedback systems, collectively referred to as *sensorless* systems, are also used. Both feedback systems can also be used in combination to further improve the control quality.

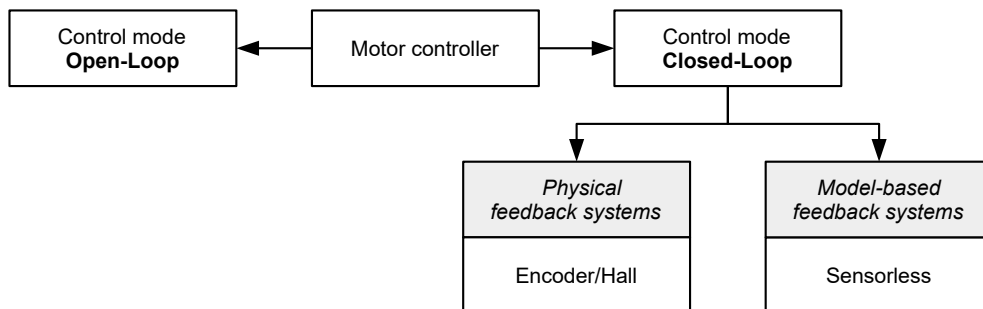

Summarized in the following are all possible combinations of control modes and feedback systems with respect to the motor technology. Support of the respective control mode and feedback is controller-specific and is described in chapters *Pin assignment* and *operating modes*.

| Control mode | Stepper motor | BLDC motor |
|--------------|---------------|------------|
| Open-Loop | yes | no |
| Closed-Loop | yes | yes |

| Feedback | Stepper motor | BLDC motor |
|----------|---------------|------------|
| Hall | no | yes |
| Encoder | yes | yes |

| Feedback | Stepper motor | BLDC motor |
|------------|---------------|------------|
| Sensorless | yes | yes |

Various operating modes can be used depending on the control mode. The following list contains all the types of operation that are possible in the various control modes.

- 1) The Profile Torque and Cyclic Synchronous Torque torque operating modes are not possible in the *open-loop* control mode due to a lack of feedback.
- 2) Exception: Homing on block is not possible due to a lack of feedback.
- 3) Because ramps and speeds in operating modes Cyclic Synchronous Position and Cyclic Synchronous Velocity follow from the specified points of the master, it is not normally possible to preselect these parameters and to ascertain whether a step loss can be excluded. It is therefore not advisable to use these operating modes in combination with *open-loop* control mode.

5.1.2 Open-Loop

5.1.2.1 Introduction

Open-loop mode is only used with stepper motors and is, by definition, a control mode without feedback. The field rotation in the stator is specified by the controller. The rotor directly follows the magnetic field rotation without step losses as long as no limit parameters, such as the maximum possible torque, are exceeded. Compared to *closed-loop*, no complex internal control processes are needed in the controller. As a result, the requirements on the controller hardware and the controller logic are very low. *Open-loop* mode is used primarily with price-sensitive applications and simple movement tasks.

Because, unlike *closed-loop*, there is no feedback for the current rotor position, no conclusion can be drawn on the counter torque being applied to the output side of the motor shaft. To compensate for any torque fluctuations that arise on the output shaft of the motor, in *open-loop* mode, the controller always supplies the maximum possible (e.g., specified by parameters) set current to the stator windings over the entire speed range. The high magnetic field strength thereby produced forces the rotor to assume the new steady state in a very short time. This torque is, however, opposite that of the inertia of the rotor and overall system. Under certain operating conditions, this combination is prone to resonances, comparable to a spring-mass system.

5.1.2.2 Commissioning

To use *open-loop* mode, the following settings are necessary:

- In object 2030_h (Pole Pair Count), enter the number of pole pairs (see motor data sheet: for a stepper motor with 2 phases, a step angle of 1.8° corresponds to 50 pole pairs and 0.9° corresponds to 100 pole pairs).
- In object 2031_h:00_h, enter the maximum permissible motor current (motor protection) in mA (see motor data sheet)
- In object 6075_h:00_h, enter the rated current of the motor in mA (see motor data sheet).
- In object 6073_h:00_h, enter the maximum current (for a stepper motor, generally corresponds to the rated current, bipolar) in tenths of a percent of the set rated current (see motor data sheet). Factory settings: "1000", which corresponds to 100% of the value in 6073_h. A value greater than "1000" is limited internally to "1000".
- In object 3202_h (Motor Drive Submode Select), set bit 0 (CL/OL) to the value "0".

Nanotec recommends the current reduction on motor standstill in order to reduce the power loss and heat build-up:

- In object 2036_h (open-loop current reduction idle time), the time in milliseconds is specified that the motor must be at a standstill (set value is checked) before current reduction is activated.
- In object 2037_h (open-loop current reduction value/factor), the root mean square is specified to which the rated current is to be reduced if current reduction is activated in *open loop* and the motor is at a standstill.

5.1.2.3 Optimizations

Depending on the system, resonances may occur in *open-loop* mode; susceptibility to resonances is particularly high at low loads. Practical experience has shown that, depending on the application, various measures are effective for largely reducing resonances:

- Reduce or increase current, see objects 6073_h and 6075_h, respectively. An excessive torque reserve promotes resonances.
- Reduce or increase the operating voltage, taking into account the product-specific ranges (with sufficient torque reserve). The permissible operating voltage range can be found in the product data sheet.
- Optimize the control parameters of the current controller via objects 3210_h:09_h (I_P) and 3210_h:0A_h (I_I) (generally not necessary).
- Adjustments to the acceleration, deceleration and/or target speed depending on the selected control mode:

Profile Position operating mode

Objects 6083_h (Profile Acceleration), 6084_h (Profile Deceleration) and 6081_h (Profile Velocity).

Velocity operating mode

Objects 6048_h (Velocity Acceleration), 6049_h (Velocity Deceleration) and 6042_h (Target Velocity).

Profile Velocity operating mode

Objects 6083_h (Profile Acceleration), 6084_h (Profile Deceleration) and 6081_h (Profile Velocity).

Homing operating mode

Objects 609A_h (Homing Acceleration), 6099_h:01_h (Speed During Search For Switch) and 6099_h:02_h (Speed During Search For Zero).

Interpolated Position Mode operating mode

The acceleration and deceleration ramps can be influenced with the higher-level controller.

Cyclic Synchronous Position operating mode

The acceleration and deceleration ramps can be influenced via the external "position specification / time unit" targets.

Cyclic Synchronous Velocity operating mode

The acceleration and deceleration ramps can be influenced via the external "position specification / time unit" targets.

5.1.3 Closed-Loop

5.1.3.1 Introduction

The *closed-loop* theory is based on the idea of a control loop. A disturbance acting on a system should be compensated for quickly and without lasting deviation to adjust the control variable back to the set point.

Closed loop using a speed control as an example:

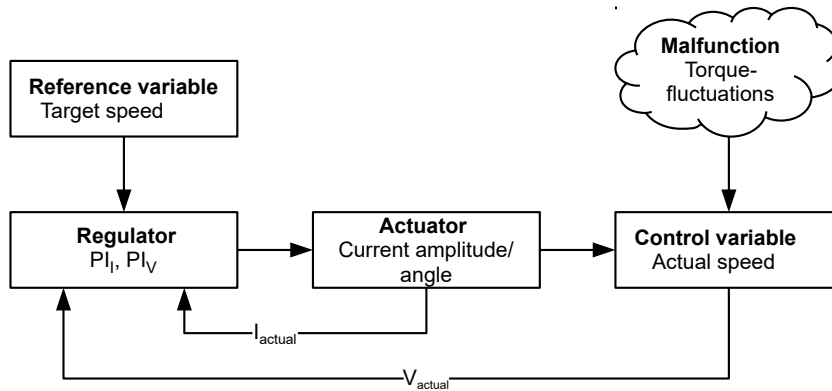

- PI_I = Proportional-integral current control loop
 PI_V = Proportional-integral velocity control loop
 I_{actual} = Actual current
 V_{actual} = Actual speed

The *closed-loop* method is also referred to as "sine commutation via an encoder with field-oriented control". At the heart of *closed-loop* technology is the performance-adjusted current control as well as the feedback of the actual values of the process. Using sensor signals, the rotor orientation is recorded and sinusoidal phase currents generated in the motor windings. Vector control of the magnetic field ensures that the magnetic field of the stator is always perpendicular to that of the rotor and that the field strength corresponds precisely to the desired torque. The current thereby controlled in the windings provides a uniform motor force and results in an especially smooth-running motor that can be precisely regulated.

The feedback of the control variables necessary for *closed-loop* mode can be realized with various technologies. In addition to the physical feedback with encoders or Hall sensors, it is also possible to virtually record the motor parameters through a software-based model calculation. Physical variables, such as speed or back-EMF, can be reconstructed with the help of a so-called "observer" from the data of the current controller. With this sensorless technology, one has a "virtual rotary encoder", which – above a certain minimum speed – supplies the position and speed information with the same precision as a real optical or magnetic encoder.

All controllers from Nanotec that support *closed-loop* mode implement a field oriented control with sine commutated current control. Thus, the stepper motors and BLDC motor are controlled in the same way as a servo motor. With *closed-loop* mode, step angle errors can be compensated for during travel and load angle errors corrected within one full step.

5.1.3.2 Controller structure

The controller consists of three cascaded PI controllers (proportional-integral): the current controller (commutation), the velocity controller and the position controller.

The current controller is active in all operating modes. The velocity controller is as well with the sole exception of the "Real Torque" modes (torque mode without speed limiting if bit 5 in `3202h` is set to "1").

The position controller is active in the following operating modes:

- Profile Position
- Homing
- Interpolated Position Mode
- Cyclic Synchronous Position
- Velocity/Profile Velocity/Cyclic Synchronous Velocity if bit 1 in `3202h` is set to "1"

Each controller consists of a proportional component with the *gain factor* K_p and an integral component with the *integrator time* T_i . The control variable (the output signal of the controller, which is the set point for the

next controller) is limited by the maximum speed (position controller), the maximum current (velocity controller) or the maximum PWM signal (current controller), respectively.

| Object | Name | Unit | Description |
|--|-----------------------------------|--|--|
| <u>321A_h:01_h</u> | Current controller | [mV/A] | Proportional component of torque-forming component |
| | Proportional Gain K_p for I_q | | |
| <u>321A_h:02_h</u> | Current controller | [μ s] | Integrator time of torque-forming component |
| | Integrator Time T_i for I_q | | |
| <u>321A_h:03_h</u> | Current controller | [mV/A] | Proportional component of field-forming component |
| | Proportional Gain K_p for I_d | | |
| <u>321A_h:04_h</u> | Current controller | [μ s] | Integrator time of field-forming component |
| | Integrator Time T_i for I_d | | |
| <u>321B_h:01_h</u> | Velocity controller | [mA/Hz] | Proportional component |
| | Proportional Gain K_p | | |
| <u>321B_h:02_h</u> | Velocity controller | [μ s] | Integrator time |
| | Integrator Time T_i | | |
| <u>321C_h:01_h</u> | Position controller | [Hz] | Proportional component |
| | Proportional Gain K_p | (Controller deviation in mech. revolutions per second) | |
| <u>321C_h:02_h</u> | Position controller | [μ s] | Integrator time |
| | Integrator Time T_i | | |

The *gain factor* K_p has a direct influence on the current control variable: at the same deviation, the control variable is proportional to the gain factor.

Each controller also has an integral component that is determined by the *integrator time* (T_i). The smaller the integrator time, the faster the control variable increases. If the integrator time is 0, the integral component is internally set to "0" and the controller only has the proportional component.

5.1.3.3 Feed forward

It is also possible to set a *velocity feed forward*, an *acceleration feed forward* (that corresponds to a torque/current value) and a *voltage feed forward*.

You can use the *feed forward* to add an already known or anticipated control variable to the set point ("predictive"). You can, e. g., compensate for the inertia of the load by adding an acceleration feed forward value to the output of the velocity controller.

The feed forward values are additionally fed to the speed/current control loop or added to the voltage value and are immediately available. A more dynamic control can thereby be achieved.

The following figure shows the current (produced by the acceleration) during the acceleration phase as a function of the *acceleration feed forward*. At a feed forward value of "50%", the current is at "50%" already at the start of the acceleration phase; the current controller is thereby "relieved".

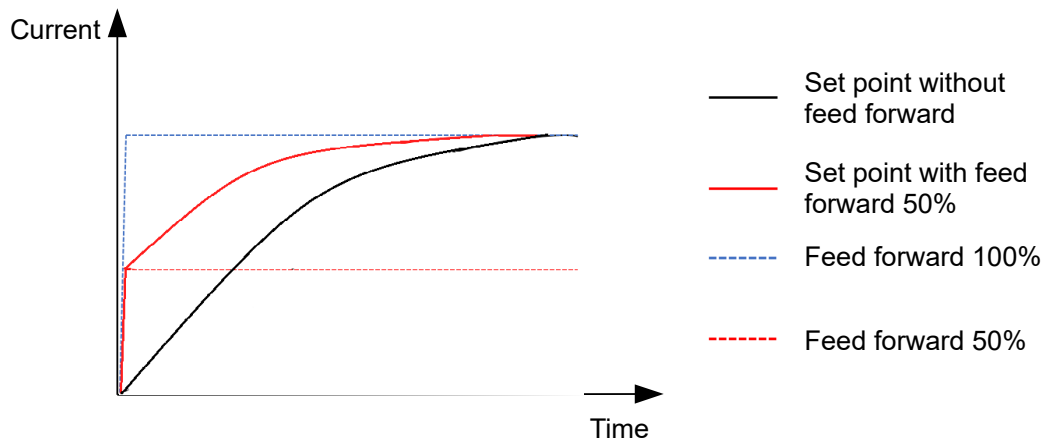

The factor for the *velocity feed forward* is set in object $321D_h:03_h$ in tenths of a percent of the output of the ramp generator ($606B_h$) and added to the output of the position controller before the velocity controller. The *velocity feed forward* is active in all modes with position control loop:

- Profile Position
- Homing
- Interpolated Position Mode
- Cyclic Synchronous Position
- Velocity/Profile Velocity if bit 1 in 3202_h is set to "1"

The factor for the *acceleration feed forward* is set in object $321D_h:02_h$ in tenths of a percent of the factor of $320D_h$ and multiplied by the output of the ramp generator (6074_h). The value is added to the output of the velocity controller before the current controller. The *acceleration feed forward* is active in all modes, with the exception of the torque modes.

The following figure shows the cases in which the feed forward is active and the position of the feed forward within the controller cascade.

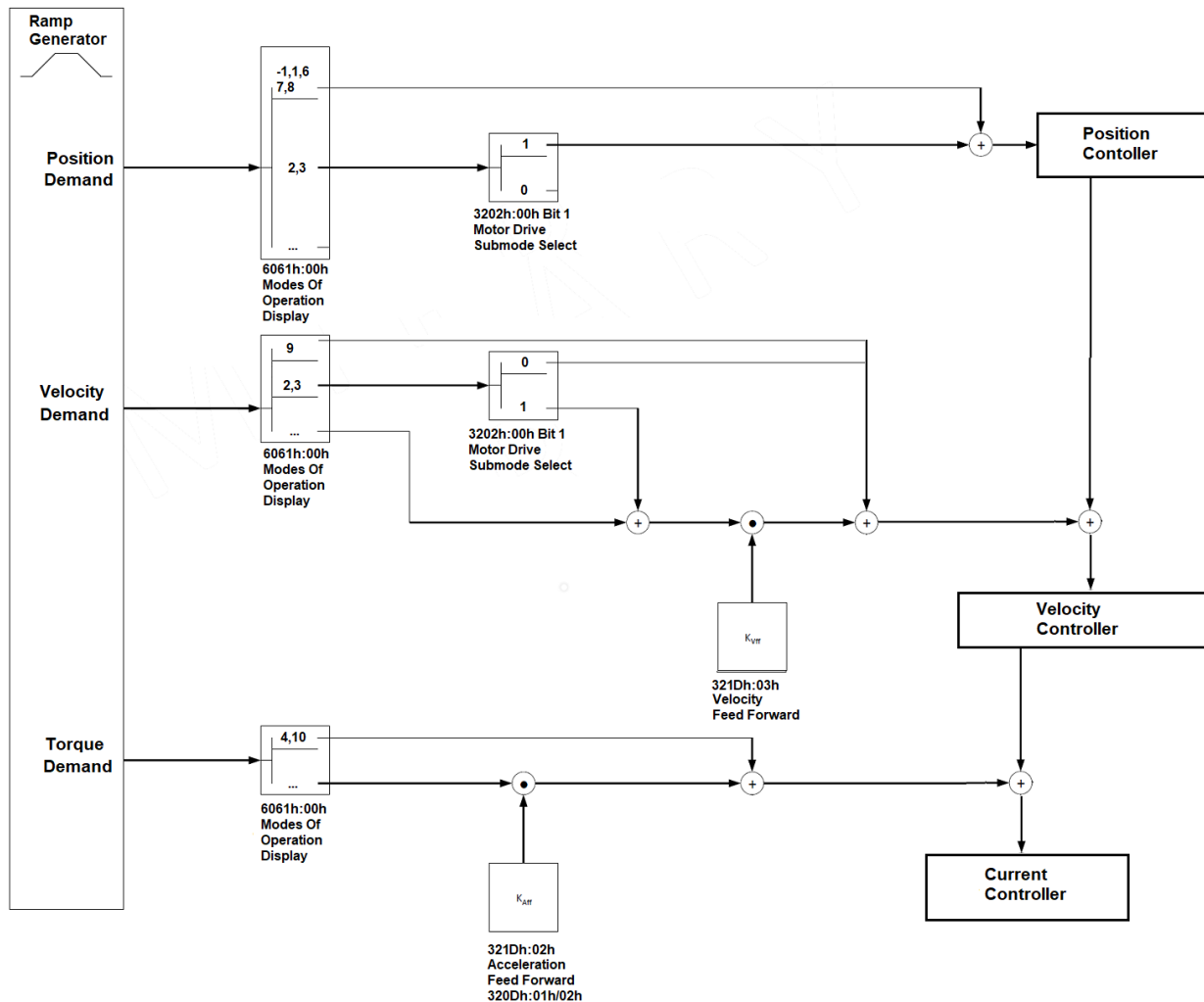

The d- and q-current controllers have a reciprocal influence on one another. To neutralize this coupling, voltages are precalculated by the controller and added to the voltages calculated by the current controller. You can adjust this decoupling with object [321Dh:01h](#) (factory setting 1000 %).

The voltage required for a desired current can be precalculated based on the value for the ohmic resistance determined in auto setup. With object [321Dh:04h](#), you can adjust the precalculated voltage (factory setting 0 %). If this voltage is immediately available, the actual current can very quickly follow the set value and support the integral component of the current controller. When using this *voltage feed forward*, you should increase the Ti time values of the current controller in object [321Ah](#) accordingly (significantly).

5.1.3.4 Commissioning

An auto setup should be performed before using *closed-loop* mode. The auto setup operating mode automatically determines the necessary parameters (e.g., motor data, feedback systems) that are necessary for optimum operation of the field oriented control. All information necessary for performing the auto setup can be found in chapter [Auto setup](#).

Bit 0 in [3202h](#) must be set. The bit is set automatically after a successfully completed auto setup.

5.1.3.5 Optimizations

In *closed-loop*, the measured control variable (actual value) is constantly compared with a set point (set value). In the event of deviations between these values, the controller readjusts according to the specified control parameters.

The objective of control parameter optimization (the so-called *tuning* of the controller) is the smoothest possible running of the motor, high accuracy and high dynamics in the reaction of the controller to faults. All control deviations should be eliminated as quickly as possible.

Due to the cascaded Controller structure, it is useful to start the optimization of the inner-most controller (current controller) before the velocity and – if applicable – the position controller are optimized. Each of the three controllers consists of a proportional and an integral component, which should normally be adjusted in this order.

The following figures show the reaction of the controller to a change in set value.

If the proportional component is too small, the actual value remains below the set value. A proportional component that is too large, on the other hand, results in "overshooting".

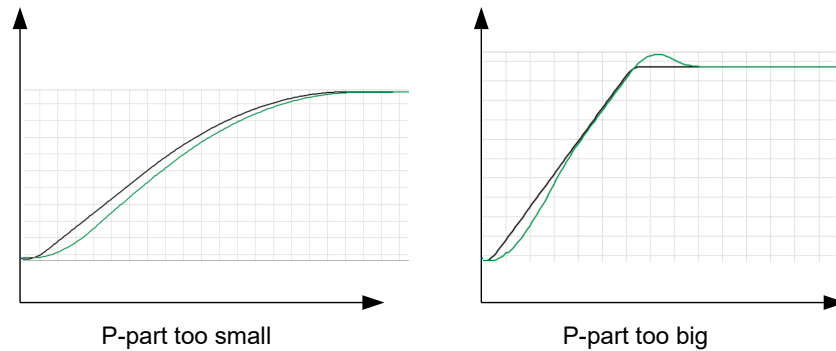

If the integrator time is too small, the system tends toward oscillations. If the integrator time is too large, the deviations are compensated for too slowly.

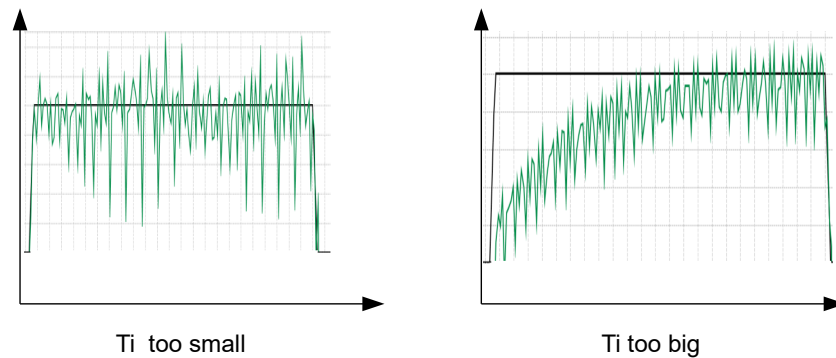

CAUTION!

Risk of injury through uncontrolled motor movements!

Incorrect control parameters may result in an unstable control behavior. Unforeseen reactions can result.

- ▶ Increase the control parameters slowly and incrementally. Do not increase these further if you notice strong vibrations/oscillations.
- ▶ Do not reach for moving parts during operation. After switching off, wait until all movements have ended.



5.2 CiA 402 Power State Machine

5.2.1 State machine

5.2.1.1 CiA 402

To switch the controller to the ready state, it is necessary to run through a *state machine*. This is defined in *CANopen standard 402*. State changes are requested in object `6040h` (controlword). The actual state of the state machine can be found in object `6041h` (statusword).

5.2.1.2 Controlword



State changes are requested via object `6040h` (controlword).

State transitions

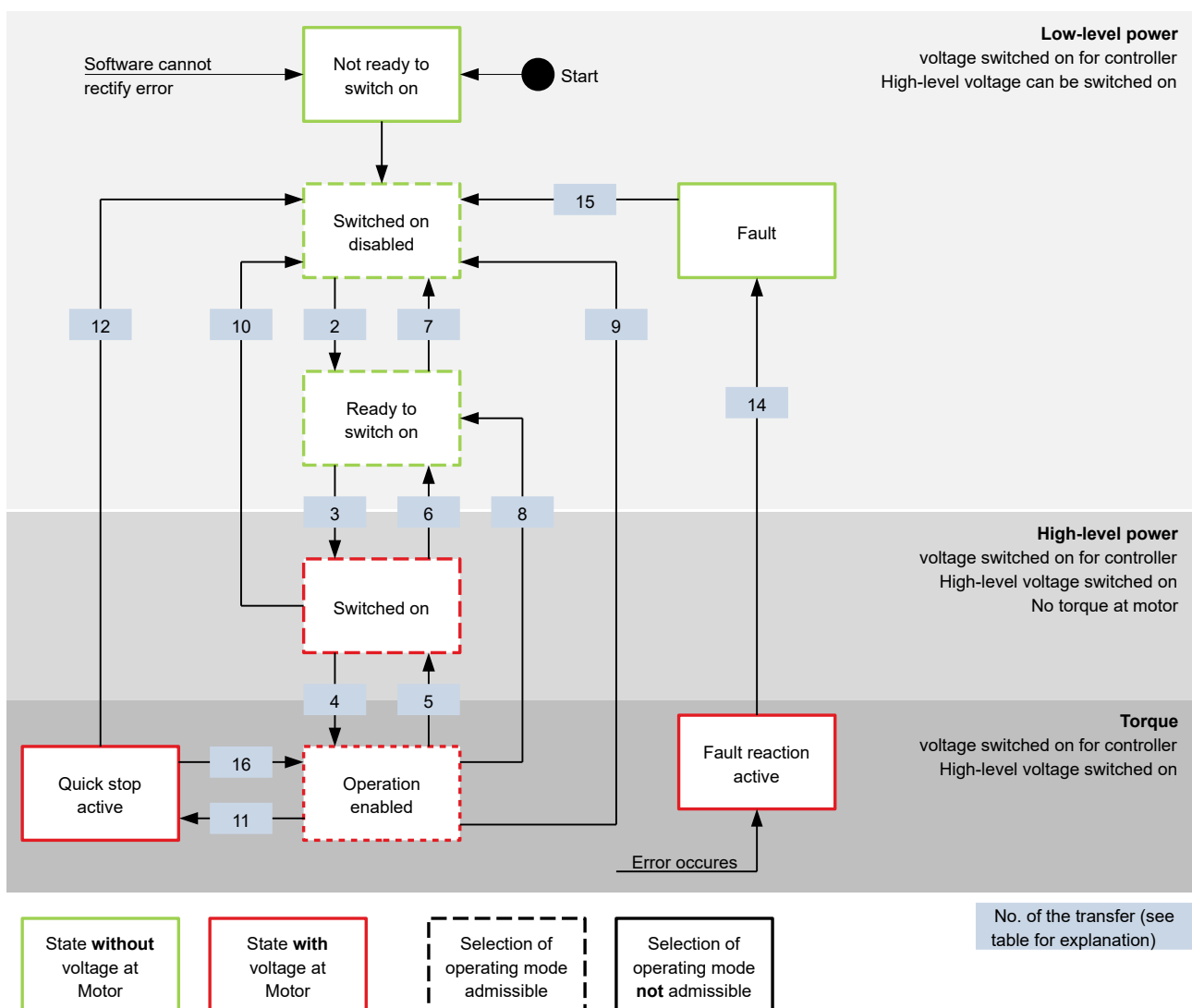
The diagram shows the possible state transitions.



Listed in the following table are the bit combinations for the controlword that result in the corresponding state transitions. An X here corresponds to a bit state that requires no further consideration. Exceptions are the resetting of the error (fault reset) and the changeover from *Quick Stop Active* to *Operation Enabled*: the transition is only requested by the rising edge of the bit.

| Command | Bit in object 6040 _h | | | | | Transition |
|-----------------------------------|---|-------|---|-------|-------|--------------|
| | Bit 7 | Bit 3 | Bit 2 | Bit 1 | Bit 0 | |
| Shutdown | 0 | X | 1 | 1 | 0 | 2, 6, 8 |
| Switch on | 0 | 0 | 1 | 1 | 1 | 3 |
| Disable voltage | 0 | X | X | 0 | X | 7, 10, 9, 12 |
| Quick stop | 0 | X | 0 | 1 | X | 11 |
| Disable operation | 0 | 0 | 1 | 1 | 1 | 5 |
| Enable operation | 0 | 1 | 1 | 1 | 1 | 4 |
| Enable operation after Quick stop | 0 | 1 |  | 1 | 1 | 16 |
| Fault / warning reset |  | X | X | X | X | 15 |

5.2.1.3 Statusword

Listed in the following table are the bit masks that break down the state of the controller.

| Statusword (6041 _h) | State |
|---------------------------------|------------------------|
| xxxx xxxx x0xx 0000 | Not ready to switch on |
| xxxx xxxx x1xx 0000 | Switch on disabled |
| xxxx xxxx x01x 0001 | Ready to switch on |
| xxxx xxxx x01x 0011 | Switched on |
| xxxx xxxx x01x 0111 | Operation enabled |
| xxxx xxxx x00x 0111 | Quick stop active |
| xxxx xxxx x0xx 1111 | Fault reaction active |
| xxxx xxxx x0xx 1000 | Fault |

After switching on and successfully completing the self-test, the controller reaches the *Switch on disabled* state.

5.2.1.4 Operating mode

The operating mode is set in object 6060_h. The actually active operating mode is displayed in 6061_h.

The operating mode can be set or changed at any time.

5.2.2 Behavior upon exiting the *Operation enabled* state

5.2.2.1 Halt motion reactions

Various halt motion reactions can be programmed upon exiting the *Operation enabled* state.

The following graphic shows an overview of the halt motion reactions.

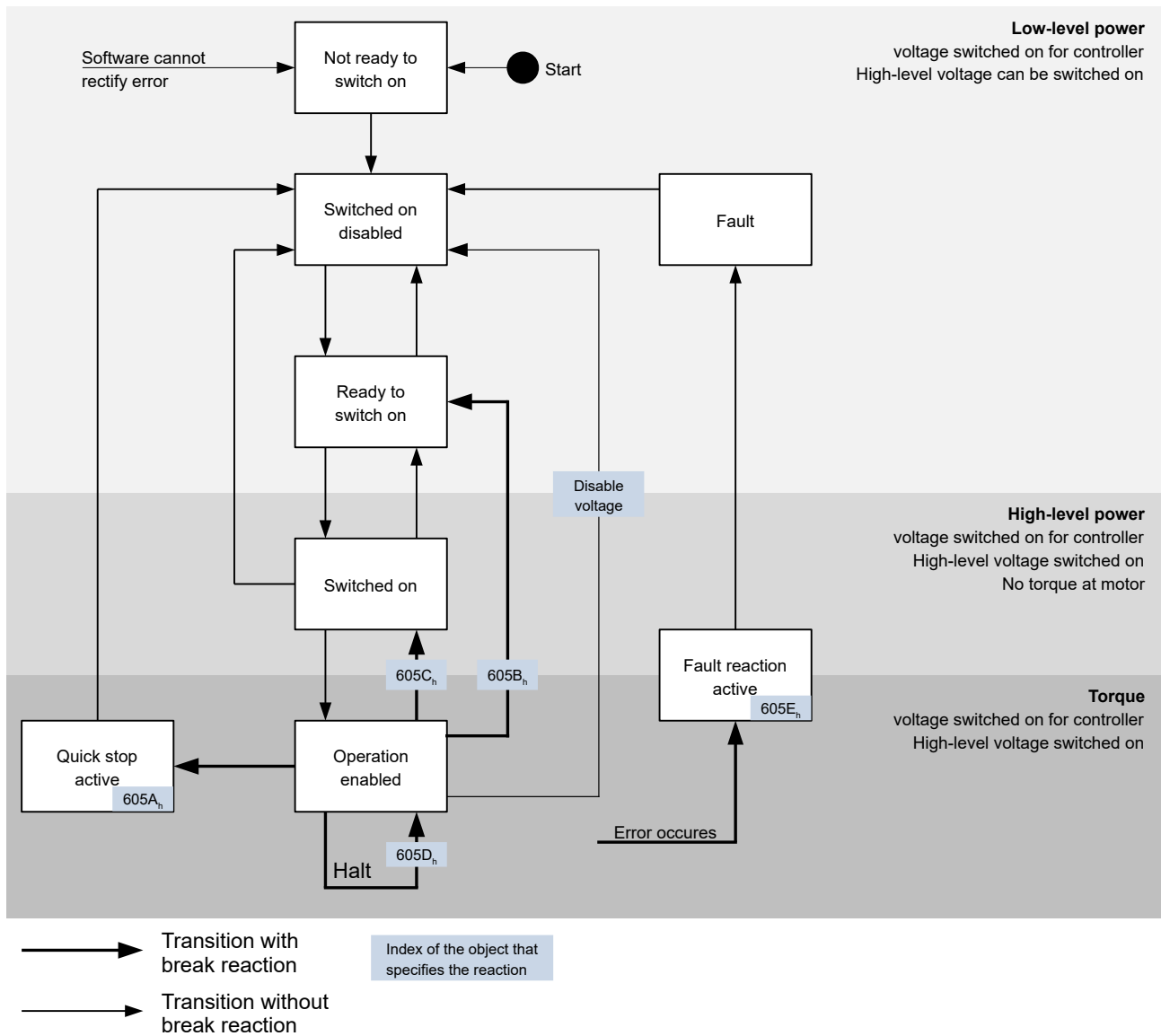

5.2.2.2 Quick stop active

Transition to the *Quick stop active* state (quick stop option):

In this case, the action stored in object 605A_n is executed (see following table).

| Value in object 605A _n | Description |
|-----------------------------------|--|
| 0 | Switch off driver without deceleration ramp; drive function blocked – motor can turn freely |
| 1 | Braking with <i>slow down ramp</i> (deceleration ramp depending on operating mode) and subsequent state change to <i>Switch on disabled</i> |
| 2 | Braking with <i>quick stop ramp</i> (6085 _n) and subsequent state change to <i>Switch on disabled</i> |
| 5 | Braking with <i>slow down ramp</i> (deceleration ramp depending on operating mode) and subsequent state change to <i>Quick stop active</i> ; control does not switch off and the motor remains energized. You can switch back to the <i>Operation enabled</i> state. |

| Value in object 605A _h | Description |
|-----------------------------------|--|
| 6 | Braking with <i>quick stop ramp</i> (6085 _h) and subsequent state change to <i>Quick Stop Active</i> ; control does not switch off and the motor remains energized. You can switch back to the <i>Operation enabled</i> state. |

The *Quick stop active* state can also be reached when a limit switch is actuated; see [Limitation of the range of motion](#).

5.2.2.3 Ready to switch on

Transition to the *Ready to switch on* state (shutdown option):

In this case, the action stored in object 605B_h is executed (see following table).

| Value in object 605B _h | Description |
|-----------------------------------|--|
| -32768 ... -1 | Reserved |
| 0 | Switch off driver without deceleration ramp; drive function blocked – motor can turn freely |
| 1 | Braking with <i>slow down ramp</i> (braking deceleration depending on operating mode) and subsequent state change to <i>Ready to switch on</i> |
| 2 ... 32767 | Reserved |

5.2.2.4 Switched on

Transition to the *Switched on* state (disable operation option):

In this case, the action stored in object 605C_h is executed (see following table).

| Value in object 605C _h | Description |
|-----------------------------------|---|
| -32768 ... -1 | Reserved |
| 0 | Switch off driver without deceleration ramp; drive function blocked |
| 1 | Braking with <i>slow down ramp</i> (braking deceleration depending on operating mode) and subsequent state change to <i>Switched on</i> |
| 2 ... 32767 | Reserved |

5.2.2.5 Halt

The bit is valid in the following modes:

- [Profile Position](#)
- [Velocity](#)
- [Profile Velocity](#)
- [Profile Torque](#)
- [Interpolated Position Mode](#)

When setting bit 8 in object 6040_h (controlword), the action stored in 605D_h is executed (see following table):

| Value in object 605D _h | Description |
|-----------------------------------|---|
| -32768 ... 0 | Reserved |
| 1 | Braking with <i>slow down ramp</i> (braking deceleration depending on operating mode) |
| 2 | Braking with <i>quick stop ramp</i> (6085 _h) |

| Value in object 605D _h | Description |
|-----------------------------------|-------------|
| 3 ... 32767 | Reserved |

5.2.2.6 Fault

Case of an error (fault):

If an error occurs, the motor will brake according to the value stored in object 605E_h.

| Value in object 605E _h | Description |
|-----------------------------------|---|
| -32768 ... -1 | Reserved |
| 0 | Switch off driver without deceleration ramp; drive function blocked – motor can turn freely |
| 1 | Braking with <i>slow down ramp</i> (braking deceleration depending on operating mode) |
| 2 | Braking with <i>quick stop ramp</i> (6085 _h) |
| 3 ... 32767 | Reserved |

For each error that occurs, a more precise error code is stored in object 1003_h.

5.2.2.7 Following/slippage error

If a following or slippage error occurs, the motor is braked according to the value stored in object 3700_h.

| Value | Description |
|---------------|---|
| -32768 ... -2 | Reserved |
| -1 | no reaction |
| 0 | Switch off driver without deceleration ramp; drive function blocked – motor can turn freely |
| 1 | Braking with <i>slow down ramp</i> (braking deceleration depending on operating mode) |
| 2 | Braking with <i>quick stop ramp</i> (6085 _h) |
| 3 ... 32767 | reserved |

You can deactivate error monitoring by setting object 6065_h to the value "-1" (FFFFFFF_h) or object 60F8_h to the value "7FFFFFFF_h".

5.3 User-defined units

The controller offers you the possibility to set user-defined units. It is thereby possible to set and read out the corresponding parameters, e.g., directly in degrees [°], millimeter [mm], etc.

Depending on the mechanical circumstances, you can also define a Gear ratio and/or a Feed constant.

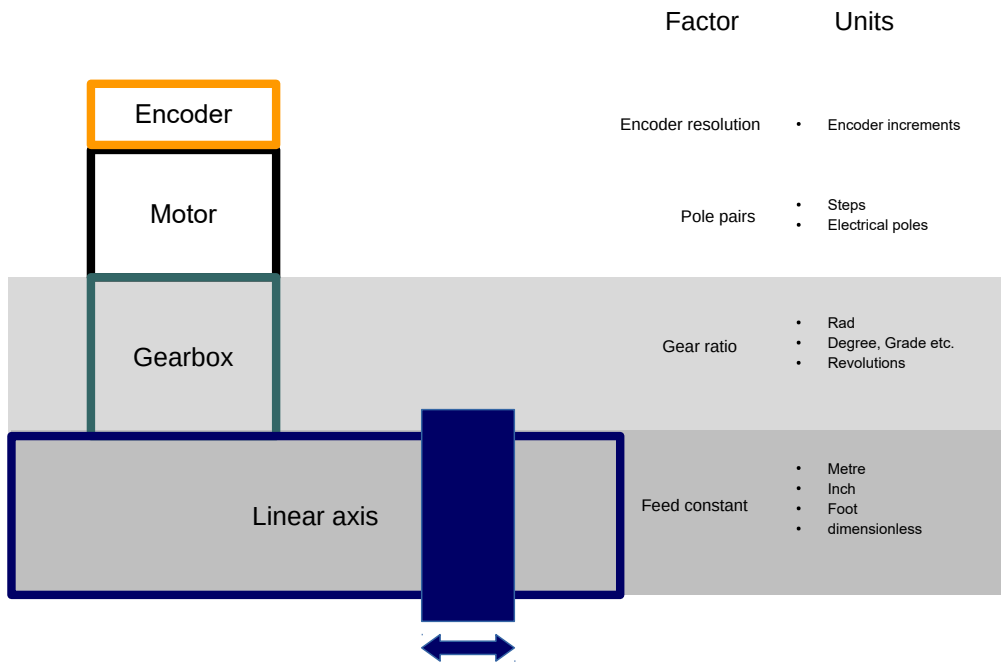

NOTICE



Value changes of all objects that are described in this chapter are not immediately applied in the *Operation enabled* state of the CiA 402 Power State Machine. For this to happen, the *Operation enabled* state must be exited.

5.3.1 Units

Units of the international unit system (*SI*) as well as a number of specific units are supported. It is also possible to specify a power of ten as a factor.

Listed in the following table are all supported units for the position and their values for 60A8_h (Position unit) or 60A9_h (Speed unit). Depending on the unit that is used, Feed constant (6092_h) and/or Gear ratio (6091_h) are/is taken into account.

| Name | Unit symbol | Value | 6091 _h | 6092 _h | Description |
|-----------------------|-------------|-----------------|-------------------|-------------------|---|
| meter | m | 01 _h | yes | yes | <i>Meter</i> |
| inch | in | C1 _h | yes | yes | <i>Inch</i> (=0.0254 m) |
| foot | ft | C2 _h | yes | yes | <i>Foot</i> (=0.3048 m) |
| grade | g | 40 _h | yes | no | <i>Gradian</i> (unit of angle, 400 corresponds to 360°) |
| radian | rad | 10 _h | yes | no | <i>Radian</i> |
| degree | ° | 41 _h | yes | no | <i>Degrees</i> |
| arcminute | ' | 42 _h | yes | no | <i>Arcminute</i> (60'=1°) |
| arcsecond | " | 43 _h | yes | no | <i>Arcsecond</i> (60"=1') |
| mechanical revolution | | B4 _h | yes | no | <i>Revolution</i> |

| Name | Unit symbol | Value | 6091 _h | 6092 _h | Description |
|-------------------|-------------|-----------------|-------------------|-------------------|--|
| encoder increment | | B5 _h | no | no | <i>Encoder increments.</i> Dependent on the used sensor (encoder/Hall sensor) and <i>control mode</i> . In <i>open-loop</i> and <i>sensorless mode</i> , the number of pole pairs (2030 _h) multiplied by 65536 corresponds to one motor revolution. |
| step | | AC _h | no | no | <i>Steps.</i> With 2-phase stepper motors, the number of pole pairs (2030 _h) multiplied by 4 is equivalent to one revolution. With 3-phase BLDC motors, the number of pole pairs (2030 _h) multiplied by 6 is equivalent to one revolution. |
| electrical pole | | C0 _h | no | no | <i>Electric poles.</i> With a stepper motor that has, e.g., 50 pole pairs (2030 _h), the unit corresponds to 1/50 of a revolution. |
| dimensionless | | 00 _h | yes | yes | <i>Dimensionless length unit</i> |

Listed in the following table are all supported units for the time and their values for 60A9_h (Speed unit):

| Name | Unit symbol | Value | Description |
|--------|-------------|-----------------|----------------------------|
| second | s | 03 _h | <i>Second</i> |
| minute | min | 47 _h | <i>Minute</i> |
| hour | h | 48 _h | <i>Hour</i> |
| day | d | 49 _h | <i>Day</i> |
| year | a | 4A _h | <i>Year (=365.25 days)</i> |

Listed in the following table are the possible exponents and their values for 60A8_h (Position unit) and 60A9_h (Speed unit):

| Factor | Exponent | Value |
|------------------|----------|-----------------|
| 10 ⁶ | 6 | 06 _h |
| 10 ⁵ | 5 | 05 _h |
| ... | ... | ... |
| 10 ¹ | 1 | 01 _h |
| 10 ⁰ | 0 | 00 _h |
| 10 ⁻¹ | -1 | FF _h |
| ... | .. | ... |
| 10 ⁻⁵ | -5 | FB _h |
| 10 ⁻⁶ | -6 | FA _h |

5.3.2 Encoder resolution

The physical resolution for position measurement of the used encoder/sensor is calculated from the encoder increments (60E6_h (Encoder Increments)) per motor revolutions (60EB_h (Motor Revolutions)).

5.3.3 Gear ratio

The gear ratio is calculated from motor revolutions (60E8_h (Motor Shaft Revolutions)) per axis rotations (60ED_h (Driving Shaft Revolutions)).

5.3.4 Feed constant

The feed constant is calculated in user-defined position units from the feed ($60E9_h$ (Feed) per revolution of the output shaft ($60EE_h$ (Driving Shaft Revolutions)).

The feed constant is useful for specifying the lead screw pitch for a linear axis and is used if the unit is based on length dimensions or if it is dimensionless.

5.3.5 Calculation formulas for user units

5.3.5.1 Position unit

Object $60A8_h$ contains:

- Bits 16 to 23: The position unit (see chapter [Units](#))
- Bits 24 to 31: The exponent of a power of ten (see chapter [Units](#))

| | | | | | | | | | | | | | | | |
|----------------|----|----|----|----|----|----|----|----------------|----|----|----|----|----|----|----|
| 31 | 30 | 29 | 28 | 27 | 26 | 25 | 24 | 23 | 22 | 21 | 20 | 19 | 18 | 17 | 16 |
| Factor | | | | | | | | Unit | | | | | | | |
| 15 | 14 | 13 | 12 | 11 | 10 | 9 | 8 | 7 | 6 | 5 | 4 | 3 | 2 | 1 | 0 |
| reserved (00h) | | | | | | | | reserved (00h) | | | | | | | |

Example

If $60A8_h$ is written with the value "FF410000_h" (bits 16-23=41_h and bits 24-31=FF_h), the unit is set to *tenths of degree* (factory setting).

With a relative target position ($607A_h$) of 3600, the motor moves exactly one mechanical revolution, if [Gear ratio](#) is 1:1. The [Feed constant](#) plays no role in this case.

Example

If $60A8_h$ is written with the value "FD010000_h" (bits 16-23=01_h and bits 24-31=FD_h(=-3)), the unit is set to *millimeter*.

With a relative target position ($607A_h$) of 1, the motor moves exactly one mechanical revolution, if [Feed constant](#) and [Gear ratio](#) are 1:1.

If the [Feed constant](#) is set according to the lead screw pitch of a linear axis, the motor turns far enough that a feed of 1 mm is achieved.

5.3.5.2 Speed unit

Object $60A9_h$ contains:

- Bits 8 to 15: The time unit (see chapter [Units](#))
- Bits 16 to 23: The position unit (see chapter [Units](#))
- Bits 24 to 31: The exponent of a power of ten (see chapter [Units](#))

| | | | | | | | | | | | | | | | |
|--------------------|----|----|----|----|----|----|----|----------------------|----|----|----|----|----|----|----|
| 31 | 30 | 29 | 28 | 27 | 26 | 25 | 24 | 23 | 22 | 21 | 20 | 19 | 18 | 17 | 16 |
| Factor | | | | | | | | Nominator (Position) | | | | | | | |
| 15 | 14 | 13 | 12 | 11 | 10 | 9 | 8 | 7 | 6 | 5 | 4 | 3 | 2 | 1 | 0 |
| Denominator (Time) | | | | | | | | reserved (00h) | | | | | | | |

Example

If 60A9_h is written with the value "00B44700_h" (bits 8-15=00_h, bits 16-23=B4_h and bits 24-31=47_h), the unit is set to *revolutions per minute* (factory setting).

Example

If 60A9_h is written with the value "FD010300_h" (bits 8-15=FD_h(=-3), bits 16-23=01_h and bits 24-31=03_h), the unit is set to *millimeters per second*.

NOTICE



The speed unit in Velocity mode is preset to *revolutions per minute*. You can only set the unit via the 604Ch VI Dimension Factor.

Conversion factor for the speed unit

You can set an additional factor for the speed unit. Thus, a unit of, e.g., 1/3 revolutions/minute is possible. The factor n is calculated from the factor for numerator (6096_h:01_h) divided by the factor for denominator (6096_h:02_h).

$$n_{\text{velocity}} = \frac{6096_{\text{h}}:01}{6096_{\text{h}}:02}$$

5.3.5.3 Acceleration unit

The acceleration unit is speed unit per second.

Conversion factor for the acceleration unit

The factor n for the acceleration unit is calculated from the numerator (6097_h:01_h) divided by the denominator (6097_h:02_h).

$$n_{\text{acceleration}} = \frac{6097_{\text{h}}:01}{6097_{\text{h}}:02}$$

5.3.5.4 Jerk unit

The jerk unit is Acceleration unit per second.

Conversion factor for jerk

The factor n for the jerk is calculated from the numerator (60A2_h:01_h) divided by the denominator (60A2_h:02_h).

$$n_{\text{jerk}} = \frac{60A2_{\text{h}}:01}{60A2_{\text{h}}:02}$$

5.4 Limitation of the range of motion

5.4.1 Software limit switches

The controller takes into account software limit switches ($607D_h$ (Software Position Limit)). Target positions ($607A_h$) are limited by $607D_h$; the absolute target position may not be larger than the limits in $607D_h$. If the motor is located outside of the permissible range when setting up the limit switches, only travel commands in the direction of the permissible range are accepted.

5.5 Cycle times

The controller operates with a cycle time of 1 ms. This means that data are processed every 1 ms; multiple changes to a value (e.g., value of an object or level at a digital input) within one ms cannot be detected.

The following table includes an overview of the cycle times of the various processes.

| Task | Cycle time |
|---------------------|-----------------------|
| Application | 1 ms |
| NanoJ application | 1 ms |
| Current controller | 62.5 μ s (16 KHz) |
| Velocity controller | 250 μ s (4 kHz) |
| Position controller | 1 ms |

6 operating modes

6.1 Profile Position

6.1.1 Overview

6.1.1.1 Description

Profile Position Mode is used to move to positions relative to the last target position or to an absolute position (last reference position). During the movement, the limit values for the speed, starting acceleration/braking deceleration and jerks are taken into account.

6.1.1.2 Activation

To activate the mode, the value "1" must be set in object `6060h` (Modes Of Operation) (see "CiA 402 Power State Machine").

6.1.1.3 Controlword

The following bits in object `6040h` (controlword) have a special function:

- Bit 4 starts a travel command. This is carried out on a transition from "0" to "1". An exception occurs if changing from another operating mode to *profile position*: If bit 4 is already set, it does not need to be set to "0" and then back to "1" in order to start the travel command.
- Bit 5: If this bit is set to "1", a travel command triggered by bit 4 is immediately executed. If it is set to "0", the just executed travel command is completed and only then is the next travel command started.
- Bit 6: With "0", the target position (`607Ah`) is absolute and with "1" the target position is relative. The reference position is dependent on bits 0 and 1 of object `60F2h`.
- Bit 8 (Halt): If this bit is set to "1", the motor stops. On a transition from "1" to "0", the motor accelerates with the set start ramp to the target speed. On a transition from "0" to "1", the motor brakes and comes to a standstill. The braking deceleration is dependent here on the setting of the "Halt Option Code" in object `605Dh`.
- Bit 9 (Change on setpoint): If this bit is set, the speed is not changed until the first target position is reached. This means that, before the first target is reached, no braking is performed, as the motor should not come to a standstill at this position.

| Controlword 6040 _h | | |
|-------------------------------|-------|--|
| Bit 9 | Bit 5 | Definition |
| X | 1 | The new target position is moved to immediately. |
| 0 | 0 | Positioning is completed before moving to the next target position with the new limits. |
| 1 | 0 | The current target position is only passed through; afterwards, the new target position is moved to with the new values. |

For further information, see figure in "Setting travel commands".

NOTICE



Bit 9 in the controlword is ignored if the ramp speed is not met at the target point. In this case, the controller would need to reset and take a run-up to reach the preset.

6.1.1.4 Statusword

The following bits in object `6041h` (statusword) have a special function:

- Bit 10 (Target Reached): This bit is set to "1" if the last target was reached and the motor remains within a tolerance window (6067_h) for a preset time (6068_h). The bit is also set to "1" if the halt bit (bit 8) in 6040_h has been set and as soon as the motor is at a standstill.
- Bit 11: Limit exceeded: The demand position is above or below the limit values set in $607D_h$.
- Bit 12 (Set-point acknowledge): This bit confirms receipt of a new and valid set point. It is set and reset in sync with the "New set-point" bit in the controlword.
 There is an exception in the event that a new movement is started before another one has completed and the next movement is not to occur until after the first one has finished. In this case, the bit is reset if the command was accepted and the controller is ready to execute new travel commands. If a new travel command is sent even though this bit is still set, the newest travel command is ignored.
 The bit is not set if one of the following conditions is met:
 - The new target position can no longer be reached while adhering to all boundary conditions.
 - A target position was already traveled to and a target position was already specified. A new target position can only be specified after the current positioning has been concluded.
- Bit 13 (Following Error): This bit is set in *closed loop* mode if the following error is greater than the set limits (6065_h (Following Error Window) and 6066_h (Following Error Time Out)).

6.1.2 Setting travel commands

6.1.2.1 Travel command

In object $607A_h$ (Target Position), the new target position is specified in user units (see [User-defined units](#)). The travel command is then triggered by setting bit 4 in object 6040_h (controlword). If the target position is valid, the controller responds with bit 12 in object 6041_h (statusword) and begins the positioning move. As soon as the position is reached, bit 10 in the statusword is set to "1".

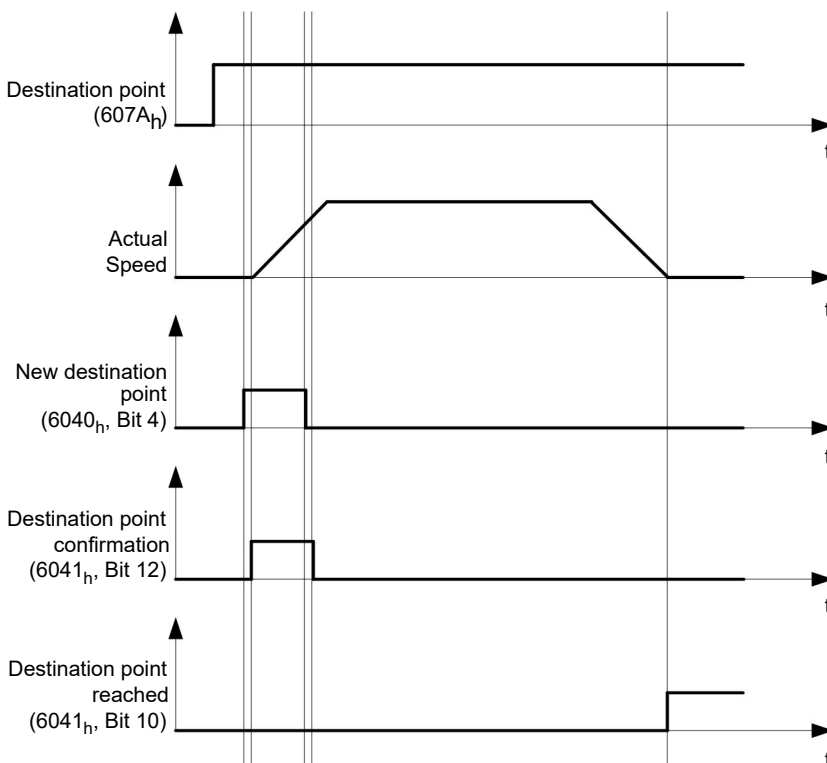

The controller can also reset bit 4 in object 6040_h (controlword) on its own. This is set with bits 4 and 5 of object $60F2_h$.

6.1.2.2 Other travel commands

Bit 12 in object 6041_h (statusword, set-point acknowledge) changes to "0" if another travel command can be buffered (see time 1 in the following figure). As long as a target position is being moved to, a second target position can be passed to the controller in preparation. All parameters – such as speed, acceleration, braking

deceleration, etc. – can thereby be reset (time 2). If the buffer is empty, the next time can be queued up (time 3).

If the buffer is already full, a new set point is ignored (time 4). If bit 5 in object 6040_h (controlword, bit: "Change Set-Point Immediately") is set, the controller operates without the buffer; new travel commands are implemented directly (time 5).

Times

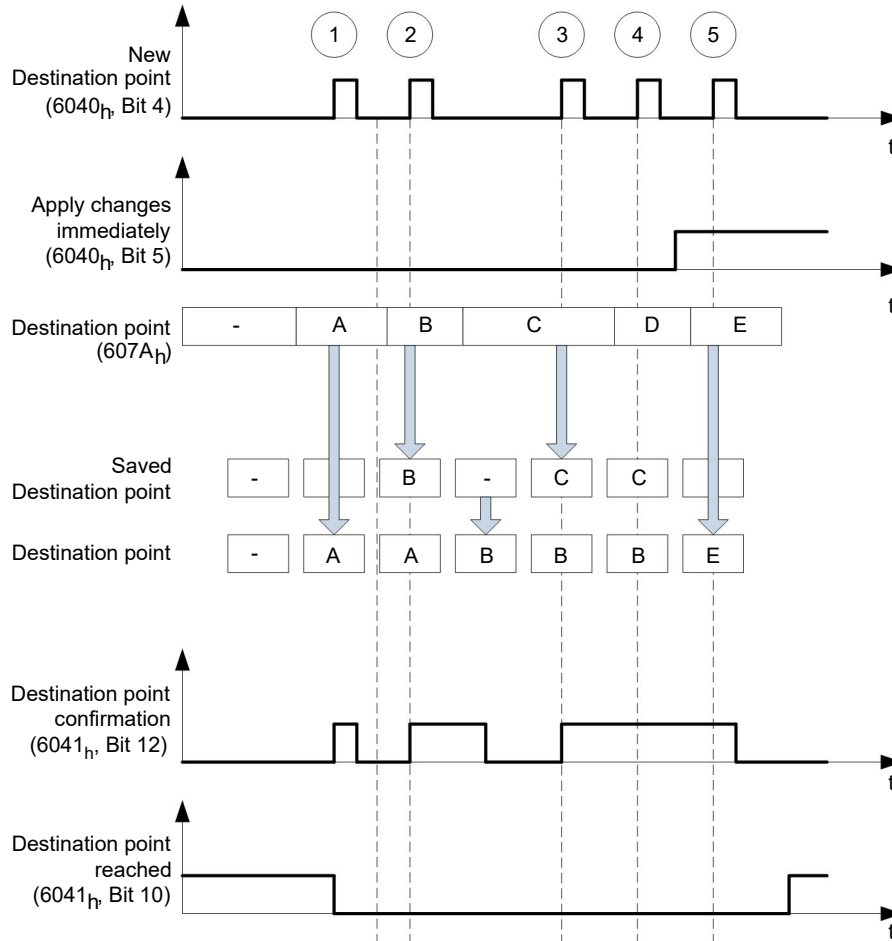

Transition procedure for second target position

The following graphic shows the transition procedure for the second target position while moving to the first target position. In this figure, bit 5 of object 6040_h (controlword) is set to "1"; the new target value is, thus, taken over immediately.

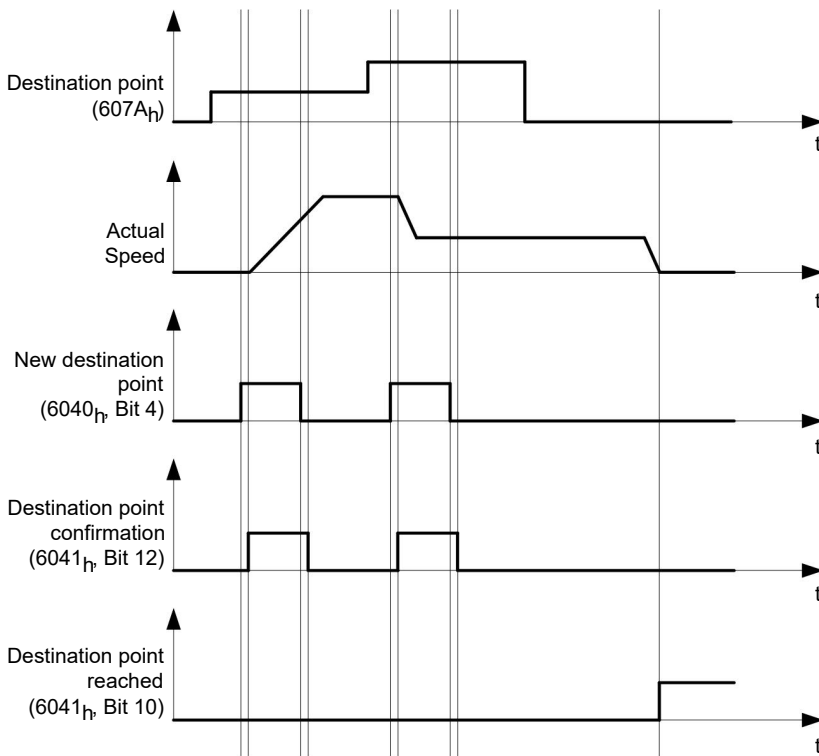

Possibilities for moving to a target position

If bit 9 in object 6040_h (controlword) is equal to "0", the current target position is first moved to completely. In this example, the final speed (6082_h) of the target position is equal to zero. If bit 9 is set to "1", the profile speed (6081_h) is maintained until the target position is reached; only then do the new boundary conditions apply.

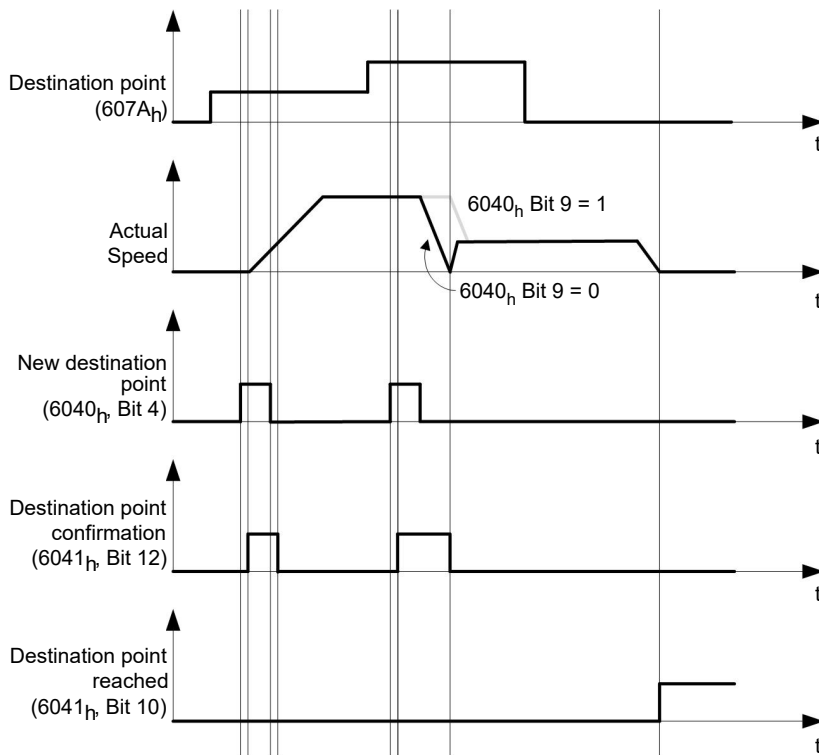

Possible combinations of travel commands

To provide a better overview of the travel commands, combinations of travel commands are listed and depicted in this chapter.

The following applies for the figures below:

- A double arrow indicates a new travel command.
- The first travel command at the start is always an absolute travel command to position 1100.
- The second movement is performed at a lower speed so as to present the graphs in a clear manner.

- Change on setpoint ($6040_h;00$ Bit 5 = 0)
- Move absolute ($6040_h;00$ Bit 6 = 0)
- Target position: 300

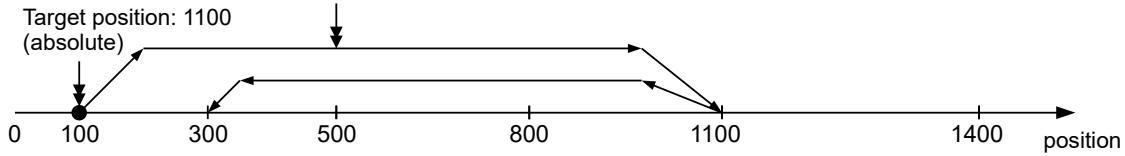

- Relative to the preceding target position ($60F2_n;00 = 0$)
- Change on setpoint ($6040_h;00$ Bit 5 = 0)
- Move relative ($6040_h;00$ Bit 6 = 1)
- Target position: 300

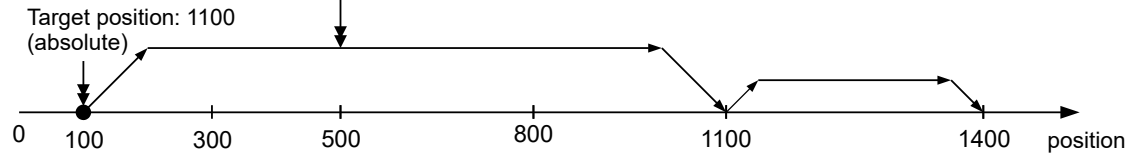

- Change set immediately ($6040_h;00$ Bit 5 = 1)
- Move absolute ($6040_h;00$ Bit 6 = 0)
- Target position: 300

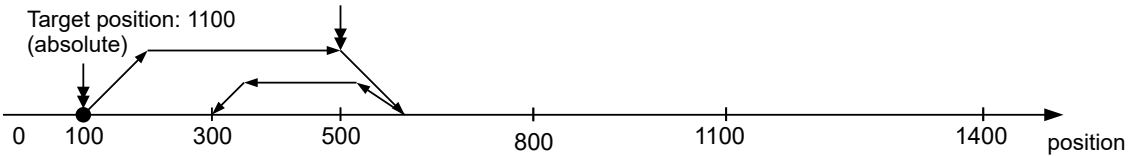

- Relative to the preceding target position ($60F2_n;00 = 0$)
- Change set immediately ($6040_h;00$ Bit 5 = 1)
- Move relative ($6040_h;00$ Bit 6 = 1)
- Target position: 300

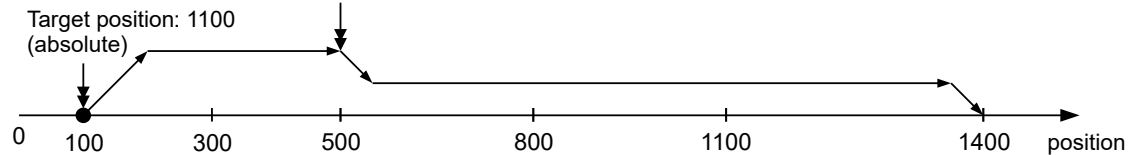

- Change on setpoint (6040_h:00 Bit 5 = 0)
- Move absolute (6040_h:00 Bit 6 = 0)
- Target position: 300

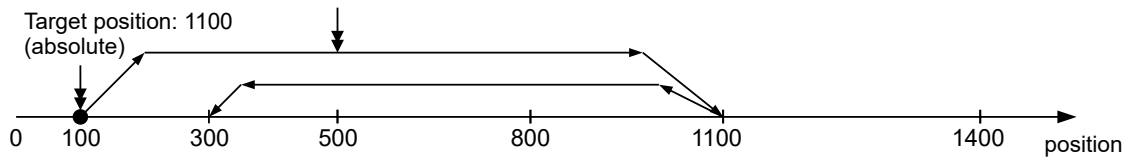

- Relative to the actual position (60F2_h:00 = 1)
- Change on setpoint (6040_h:00 Bit 5 = 0)
- Move relative (6040_h:00 Bit 6 = 1)
- Target position: 300

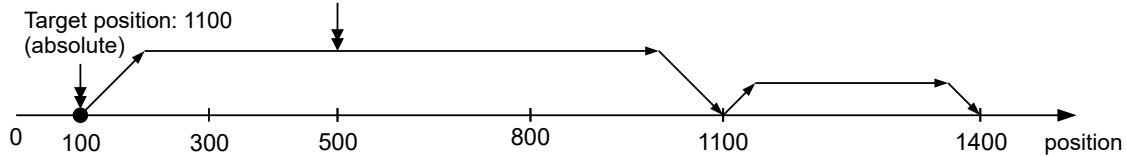

- Change set immediately (6040_h:00 Bit 5 = 1)
- Move absolute (6040_h:00 Bit 6 = 0)
- Target position: 300

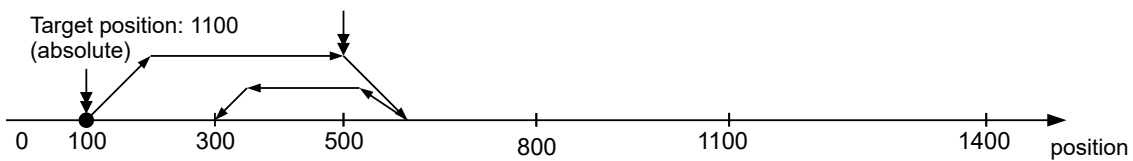

6.1.3 Loss of accuracy for relative movements

When linking together relative movements, a loss of accuracy may occur if the final speed is not set to zero. The following graphic illustrates the reason.

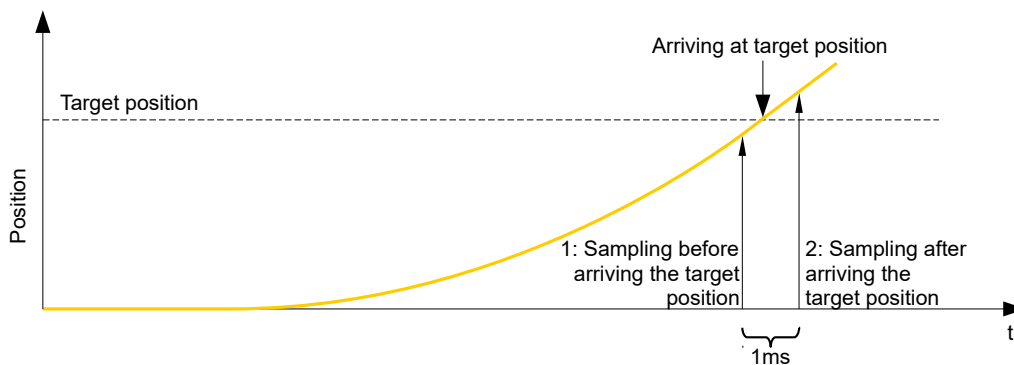

The current position is sampled once per millisecond. It is possible that the target position is reached between two samples. If the final speed is not equal to zero, then, after the target position is reached, the sample is used as an offset as the basis for the subsequent movement. As a result, the subsequent movement may go somewhat farther than expected.

6.1.4 Boundary conditions for a positioning move

6.1.4.1 Object entries

The boundary conditions for the position that has been moved to can be set in the following entries of the object dictionary:

- **607A_h**: (Target Position): Planned target position
- **607D_h**: (Software Position Limit): Definition of the limit stops (see chapter [Software limit switches](#))
- **607C_h**: (Home Offset): Specifies the difference between the zero position of the controller and the reference point of the machine in user-defined units. (See "[Homing](#)")
- **607B_h**: (Position Range Limit): Limits of a modulo operation for replicating an endless rotation axis
- **607_h**: (Polarity): Direction of rotation
- **6081_h**: (Profile Velocity): Maximum speed with which the position is to be approached
- **6082_h**: (End Velocity): Speed upon reaching the target position
- **6083_h**: (Profile Acceleration): Desired starting acceleration
- **6084_h**: (Profile Deceleration): Desired braking deceleration
- **6085_h**: (Quick Stop Deceleration): Emergency-stop braking deceleration in case of the "Quick stop active" state of the "CiA 402 Power State Machine"
- **6086_h**: (Motion Profile Type): Type of ramp to be traveled; if the value is "0", the jerk is not limited; if the value is "3", the values of 60A4_h:1_h–4_h are set as limits for the jerk.
- **60C5_h**: (Max Acceleration): The maximum acceleration that may not be exceeded when moving to the end position
- **60C6_h**: (Max Deceleration): The maximum braking deceleration that may not be exceeded when moving to the end position
- **60A4_h**: (Profile Jerk), subindex 01_h to 04_h: Objects for specifying the limit values for the jerk.
- The speed is limited by **607E_h** (Max Profile Velocity) and **6080_h** (Max Motor Speed); the smaller value is used as the limit.
- **60F2_h**: (Positioning Option Code): Defines the positioning behavior

6.1.4.2 Objects for the positioning move

The following graphic shows the objects involved in the boundary conditions of the positioning move.

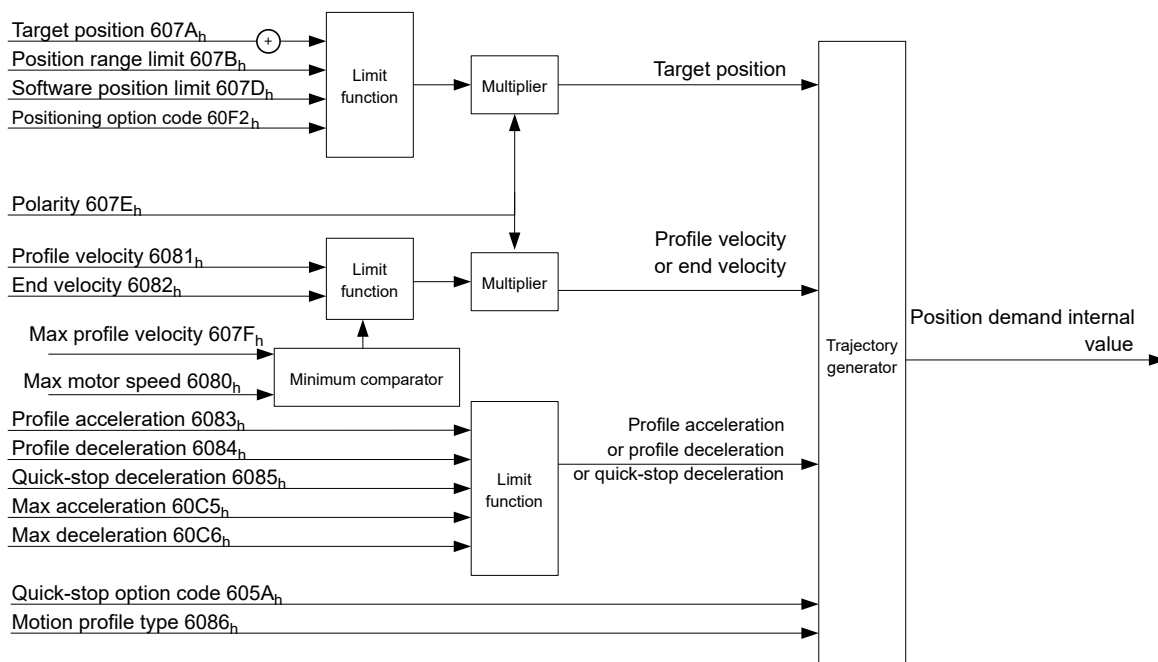

6.1.4.3 Parameters for the target position

The following graphic shows an overview of the parameters that are used for moving to a target position (figure not to scale).

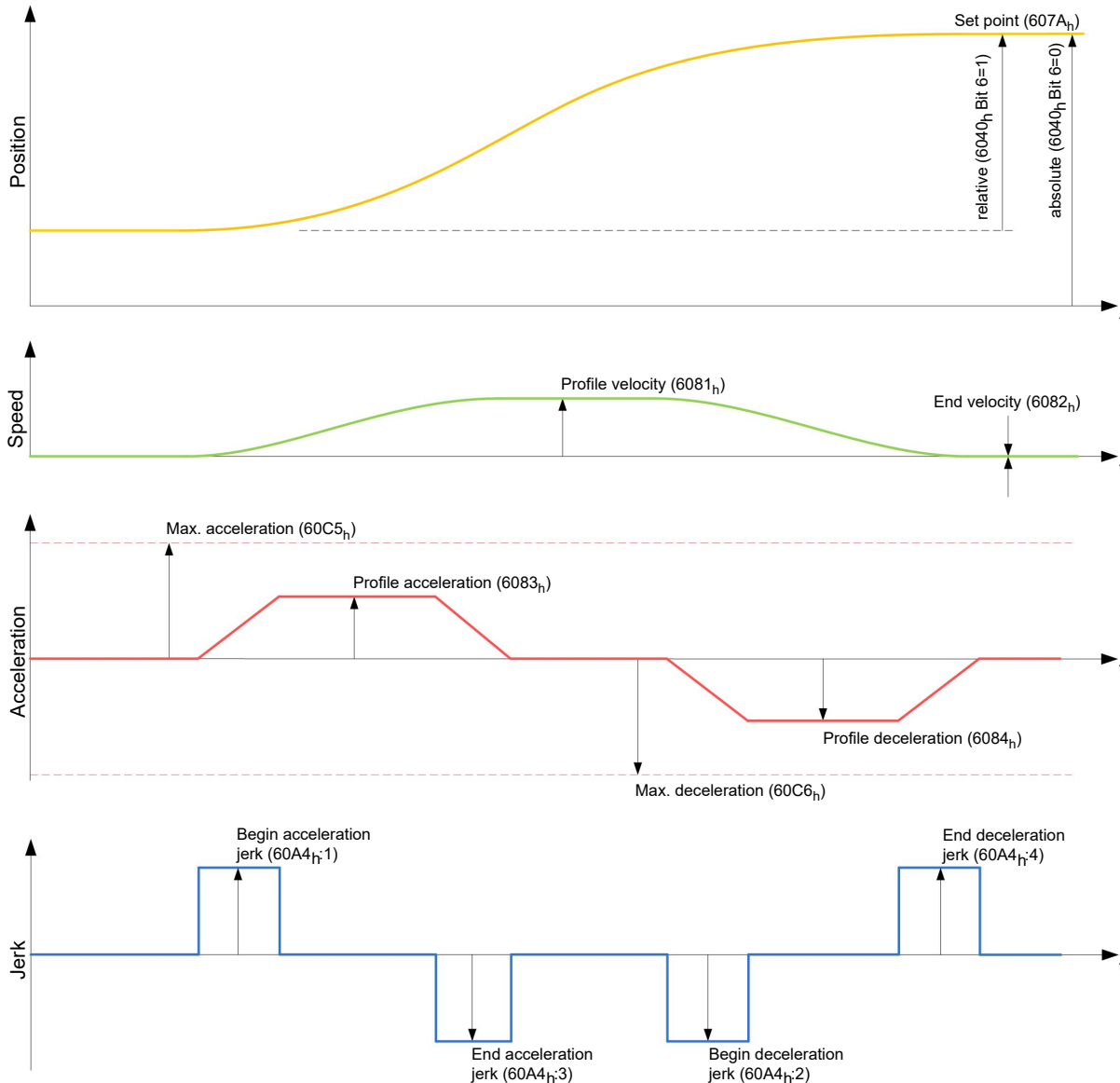

6.1.5 Jerk-limited mode and non-jerk-limited mode

6.1.5.1 Description

A distinction is made between the "jerk-limited" and "non-jerk-limited" modes.

6.1.5.2 Jerk-limited mode

Jerk-limited positioning can be achieved by setting object 6086_h to "3". The entries for the jerks in subindices :1_h–4_h of object 60A4 thereby become valid.

6.1.5.3 Non-jerk-limited mode

A "non-jerk-limited" ramp is traveled if the entry in object 6086_h is set to "0" (default setting).

6.2 Velocity

6.2.1 Description

This mode operates the motor at a preset target speed, similar to a frequency inverter. Unlike the *profile velocity mode*, this mode does not permit the selection of jerk-limited ramps.

6.2.2 Activation

To activate the mode, the value "2" must be set in object 6060_h (Modes Of Operation) (see "CiA 402 Power State Machine").

6.2.3 Controlword

The following bits in object 6040_h (controlword) have a special function:

- Bit 8 (Halt): If this bit is set to "1", the motor stops. On a transition from "1" to "0", the motor accelerates with the acceleration ramp to the target speed. On a transition from "0" to "1", the motor brakes according to the deceleration ramp and comes to a standstill.

6.2.4 Statusword

The following bits in object 6041_h (statusword) have a special function:

- Bit 11: Limit exceeded: The target speed is above or below the set limit values.

6.2.5 Object entries

The following objects are necessary for controlling this mode:

- 604C_h (Dimension Factor):
The unit for speed values is defined here for the following objects.
Subindex 1 contains the denominator (multiplier) and subindex 2 contains the numerator (divisor) with which the internal speed values are converted to revolutions per minute. If, for example, subindex 1 is set to the value "60" and subindex 2 is set to the value "1", the speed is specified in revolutions per second (60 revolutions per 1 minute).
- 6042_h: Target Velocity.
The target speed is set here in user-defined units.
- 6048_h: Velocity Acceleration
This object defines the acceleration. Subindex 1 contains the change in speed, subindex 2 the corresponding time in seconds. Both together are used to calculate the acceleration:

$$\text{VL velocity acceleration} = \frac{\text{Delta speed (6048}_{h}:1)}{\text{Delta time (6048}_{h}:2)}$$

- 6049_h (Velocity Deceleration):
This object defines the deceleration (deceleration ramp). The subindices here are arranged as described in object 6048_h; the change in speed is to be specified with positive sign.
- 6046_h (Velocity Min Max Amount):
The limitations of the target speeds are specified in this object.
The minimum speed is set in 6046_h:1_h. If the target speed (6042_h) falls below the minimum speed, the value is limited to the minimum speed 6046_h:1_h.
The maximum speed is set in 6046_h:2_h. If the target speed (6042_h) exceeds the maximum speed, the value is limited to the maximum speed 6046_h:2_h.
- 604A_h (Velocity Quick Stop):
This object can be used to set the quick-stop ramp. Subindices 1 and 2 are identical to those described for object 6048_h.

The following objects can be used to check the function:

- 6043_h (VI Velocity Demand)
- 6044_h (VI Velocity Actual Value)

6.2.5.1 Speeds in Velocity Mode

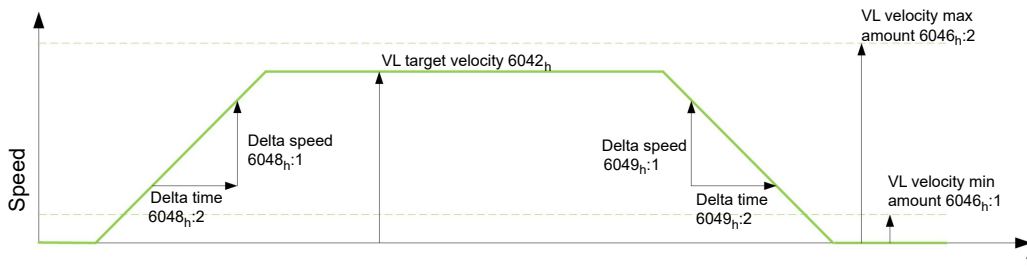

6.2.5.2 Objects for Velocity Mode

The ramp generator follows the target speed, remaining within the set speed and acceleration limits. As long as a limit is active, bit 11 in object [6041h](#) is set (internal limit active).

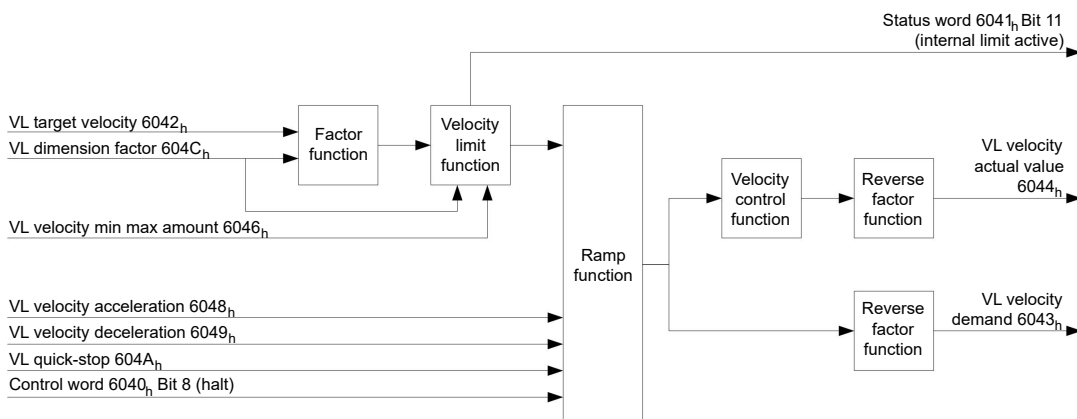

6.3 Profile Velocity

6.3.1 Description

This mode operates the motor in Velocity Mode with extended (jerk-limited) ramps. Unlike *Velocity Mode* (see "[Velocity](#)"), the [statusword](#) is used in this mode to indicate whether the target speed is reached.

6.3.2 Activation

To activate the mode, the value "3" must be set in object [6060h](#) (Modes Of Operation) (see "[CiA 402 Power State Machine](#)").

6.3.3 Controlword

The following bits in object [6040h](#) (controlword) have a special function:

- Bit 8 (Halt): If this bit is set to "1", the motor stops. On a transition from "1" to "0", the motor accelerates with the set start ramp to the target speed. On a transition from "0" to "1", the motor brakes and comes to a standstill.

6.3.4 Statusword

The following bits in object [6041h](#) (statusword) have a special function:

- Bit 10 (target speed reached; Target Reached): In combination with bit 8 in the controlword, this bit specifies whether the target speed is reached, if braking is taking place or if the motor is at a standstill (see table).

| 6041 _h Bit 10 | 6040 _h Bit 8 | Description |
|-----------------------------|----------------------------|---|
| 0 | 0 | Target speed not reached |
| 0 | 1 | Axis braking |
| 1 | 0 | Target speed within target window (defined in 606D _h and 606E _h) |
| 1 | 1 | Axis speed is 0 |

- Bit 12: This bit indicates whether the actual speed is zero.
If the actual speed is greater than the value in 606F_h(Velocity Threshold) for a time of 6070_h(Velocity Threshold Time), this bit has the value "0". The bit otherwise remains set to "1".
- Bit 13 (Deviation Error): This bit is set in *closed loop* mode if the slippage error is greater than the set limits (60F8_h Max Slippage and 203F_h Max Slippage Time Out).

6.3.5 Object entries

The following objects are necessary for controlling this mode:

- 606B_h (Velocity Demand Value):
This object contains the output of the ramp generator, which simultaneously serves as the preset value for the velocity controller.
- 606C_h (Velocity Actual Value):
Indicates the current actual speed.
- 606D_h (Velocity Window):
This value specifies by how much the actual speed may vary from the set speed for bit 10 (target speed reached; Target Reached") in object 6041_h (statusword) to be set to "1".
- 606E_h (Velocity Window Time):
This object specifies how long the actual speed and the set speed must be close to one another (see 606D_h "Velocity Window") for bit 10 "Target speed reached" in object 6041_h (statusword) to be set to "1".
- 607E_h (Polarity):
If bit 6 is set to "1" here, the sign of the target speed is reversed.
- 6083_h (Profile acceleration):
Sets the value for the acceleration ramp.
- 6084_h (Profile Deceleration):
Sets the value for the deceleration ramp.
- 6085_h (Quick Stop Deceleration):
Sets the value for the deceleration ramp for rapid braking.
- 6086_h (Motion Profile Type):
The ramp type can be selected here ("0" = trapezoidal ramp, "3" = jerk-limited ramp).
- 60FF_h (Target Velocity):
Specifies the target speed that is to be reached.
- The speed is limited by 607E_h (Max Profile Velocity) and 6080_h (Max Motor Speed); the smaller value is used as the limit.

6.3.5.1 Objects in Profile Velocity Mode

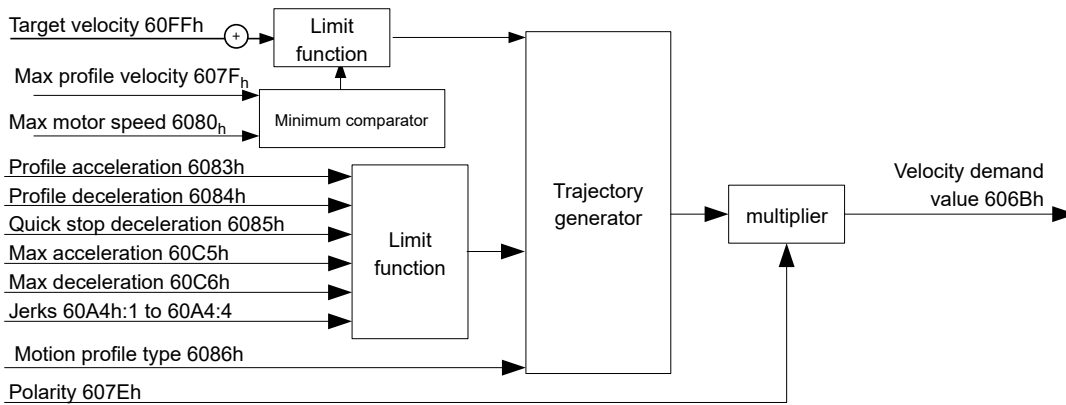

6.3.5.2 Activation

After the mode is selected in object 6060_h (Modes Of Operation) and the "Power State machine" (see "CiA 402 Power State Machine") is switched to *Operation enabled*, the motor is accelerated to the target speed in object 60FF_h (see following figures). The speed and acceleration values are taken into account here; for jerk-limited ramps, the jerk-limit values are also taken into account.

6.3.5.3 Limitations in the jerk-limited case

The following figure shows the adjustable limits in the jerk-limited case (6086_h = 3).

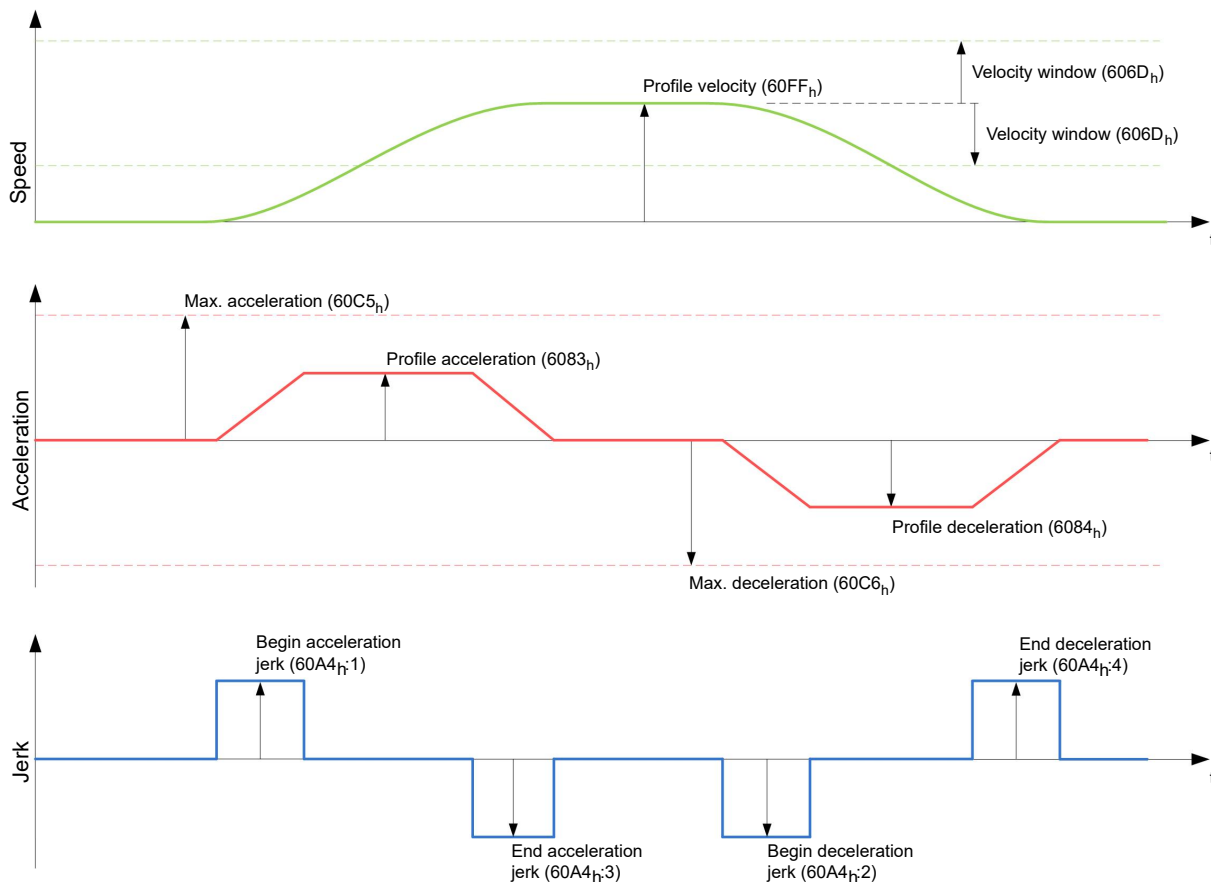

6.3.5.4 Limitations in the trapezoidal case

This figure shows the adjustable limitations for the trapezoidal case ($6086_h = 0$).

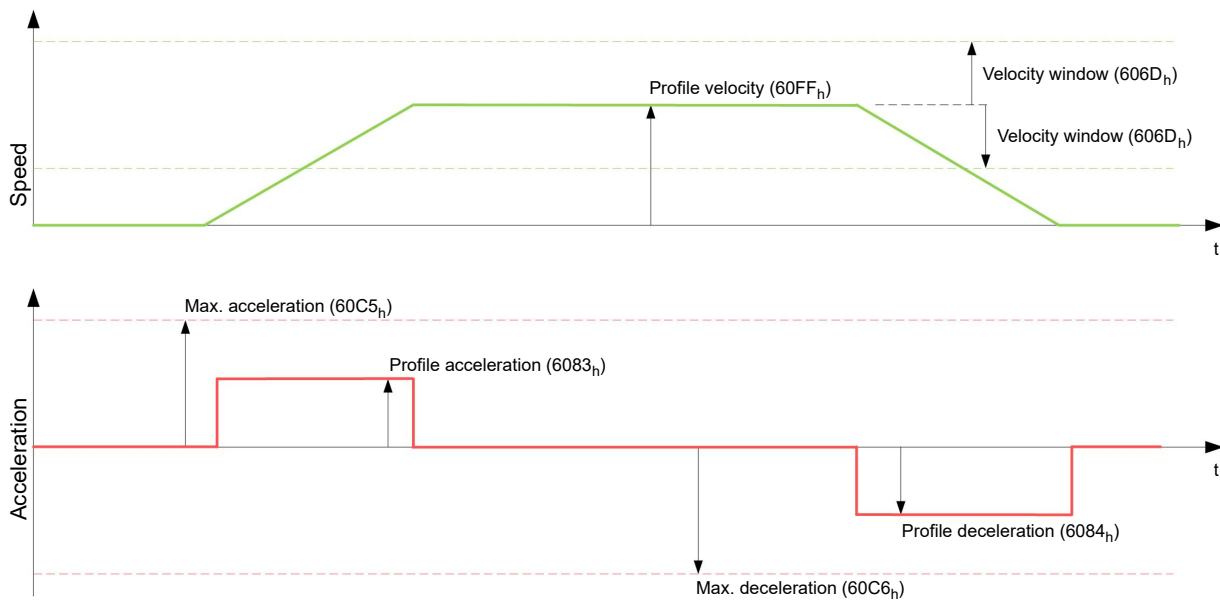

6.4 Profile Torque

6.4.1 Description

In this mode, the torque is preset as a set value and reached via a ramp function.



NOTICE

This mode only functions if closed loop is activated, see also Commissioning Closed Loop.

6.4.2 Activation

To activate the mode, the value "4" must be set in object 6060_h (Modes Of Operation) (see "CiA 402 Power State Machine").

6.4.3 Controlword

The following bits in object 6040_h (controlword) have a special function:

- Bit 8 (Halt): If this bit is set to "1", the motor stops. If this bit is set from "1" to "0", the motor is started up according to the presets. When setting from "0" to "1", the motor is again brought to a standstill, taking the preset values into consideration.

6.4.4 Statusword

The following bits in object 6041_h (statusword) have a special function:

- Bit 10 (Target Reached): In combination with bit 8 of object 6040_h (controlword), this bit indicates whether the specified torque is reached (see following table). The target is considered having been met if the current torque (6077_h Torque Actual Value) is within a tolerance window ($203D_h$ Torque Window) for a specified time ($203E_h$ Torque Window Time Out).

| 6040_h Bit 8 | 6041_h Bit 10 | Description |
|-------------------|--------------------|------------------------------|
| 0 | 0 | Specified torque not reached |

| 6040 _h Bit 8 | 6041 _h Bit 10 | Description |
|----------------------------|-----------------------------|--------------------------|
| 0 | 1 | Specified torque reached |
| 1 | 0 | Axis brakes |
| 1 | 1 | Axis speed is 0 |

- Bit 11: Limit exceeded: The target torque (6071_h) exceeds the maximum torque entered in 6072_h.

6.4.5 Object entries

All values of the following entries in the object dictionary are to be specified as a thousandth of the maximum torque, which corresponds to the rated current (203B_h:01_h). This includes the objects:

- 6071_h (Target Torque):
Target torque
- 6072_h (Max Torque):
Maximum torque during the entire ramp (accelerate, maintain torque, decelerate)
- 6073_h (Max Current):
Maximum current. The minimum of 6073_h and 6072_h is used as limit for the torque in 6071_h.
- 6074_h (Torque Demand):
Current output value of the ramp generator (torque) for the controller
- 6077 (Torque Actual Value):
Current torque value
- 6087_h (Torque Slope):
Max. change in torque per second

NOTICE



These values are not limited to 100% of the rated current (203B_h:01_h). Torque values greater than the rated torque (generated from the rated current) can be achieved if the maximum duration (203B_h:02_h) of the maximum current (6073_h) is set (see [I2t Motor overload protection](#)). All torque objects are limited by the maximum motor current (2031_h).

The following objects are also needed for this operating mode:

- 3202_h Bit 5 (Motor Drive Submode Select):
If this bit is set to "0", the drive controller is operated in the torque-limited Velocity Mode, i.e., the maximum speed can be limited in object 6080_h and the controller can operate in field weakening mode. If this bit is set to "1", the controller operates in the ("Real") Torque Mode; the maximum speed cannot be limited here and field weakening mode is not possible.

6.4.5.1 Objects of the ramp generator

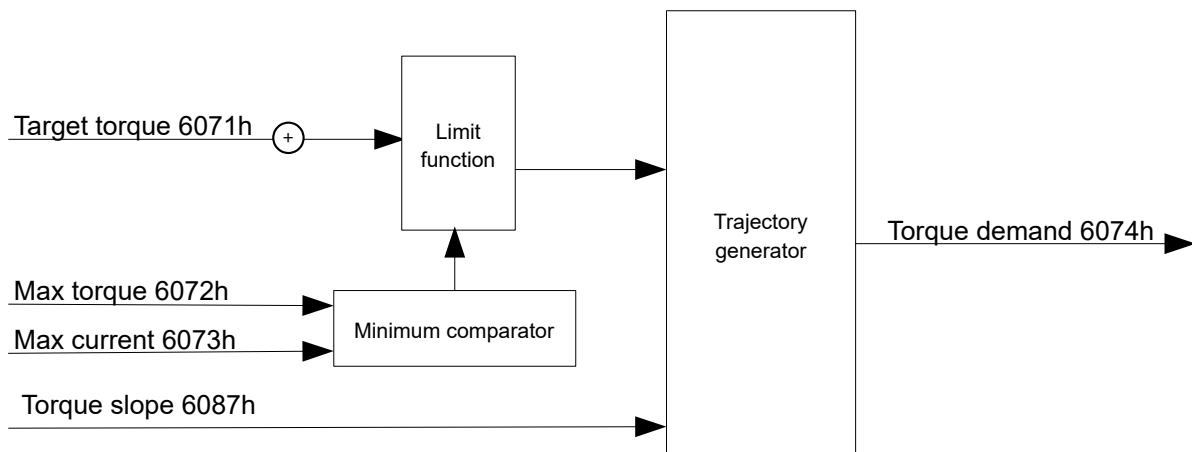

6.4.5.2 Torque curve

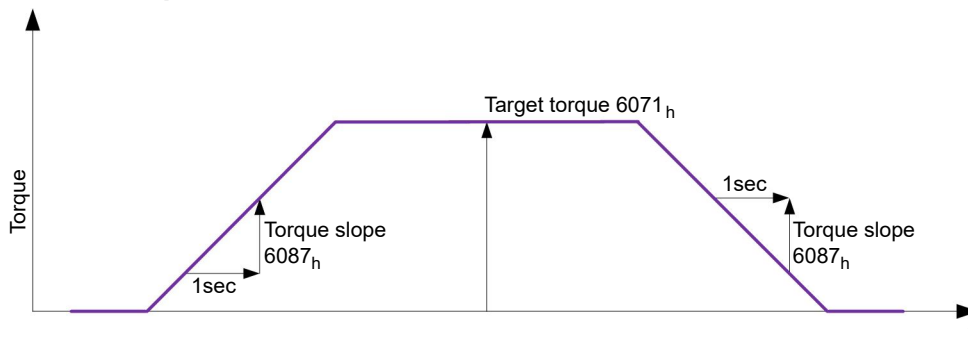

6.5 Homing

6.5.1 Overview

6.5.1.1 Description

The purpose of the homing method is to align the position zero point of the controller with an encoder index or position switch.

6.5.1.2 Activation

To activate the mode, the value "6" must be set in object 6060_h (Modes Of Operation) (see "[CiA 402 Power State Machine](#)").

TIP



If home switches and/or limit switches are used, these special functions must first be activated in the I/O configuration (see "[Digital inputs and outputs](#)").

To use the limit switch, you must also set object 3701_h to "-1" (factory setting) to prevent blocking the further travel of the motor.

6.5.1.3 Controlword

The following bits in object 6040_h (controlword) have a special function:

- Bit 4: If the bit is set to "1", referencing is started. This is performed until either the reference position is reached or bit 4 is reset to "0".

6.5.1.4 Statusword

The following bits in object `6041h` (statusword) have a special function:

| Bit 13 | Bit 12 | Bit 10 | Description |
|--------|--------|--------|--|
| 0 | 0 | 0 | Homing is performed |
| 0 | 0 | 1 | Homing is interrupted or not started |
| 0 | 1 | 0 | Homing has been performed since the last restart but target is not currently reached |
| 0 | 1 | 1 | Homing completed |
| 1 | 0 | 0 | Error during homing, motor still turning |
| 1 | 0 | 1 | Error during homing, motor at standstill |

NOTICE

Bit 12 in *Homing* mode is set to 1 after the first fully completed homing operation since the restart. It is only reset to 0



- during all subsequent homing operations
- in the event of an error during a homing operation (permanently deleted until a new homing operation is fully completed).

6.5.1.5 Object entries

The following objects are necessary for controlling this mode:

- `607Ch` (Home Offset): Specifies the difference between the zero position of the controller and the reference point of the machine in user-defined units.
- `6098h` (Homing Method):
Method to be used for referencing (see "Homing method")
- `6099h:01h` (Speed During Search For Switch):
Speed for the search of the switch
- `6099h:02h` (Speed During Search For Zero):
Speed for the search of the index
- `6080h` (Max Motor Speed): Maximum speed
- `609Ah` (Homing Acceleration):
Starting acceleration and braking deceleration for homing. Also used in case of a quick stop.
- `203Ah:01h` (Minimum Current For Block Detection):
Minimum current threshold which, if exceeded, is to detect the blocking of the motor at a block.
- `203Ah:02h` (Period Of Blocking):
Specifies the time in ms that the motor is to continue to run against the block after block detection.

Homing speeds

The figure shows the homing speeds using method 4 as an example:

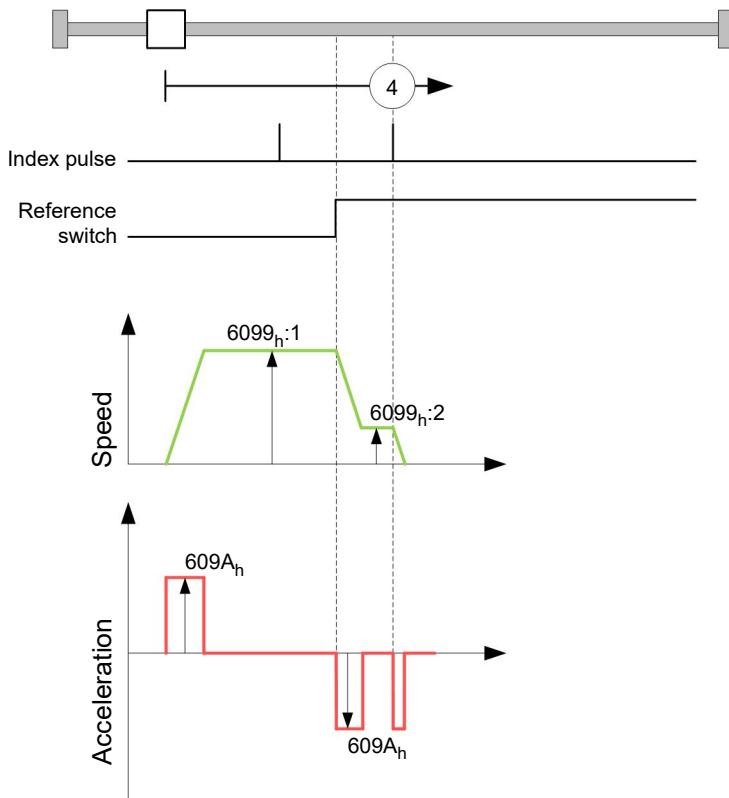

6.5.2 Homing method

6.5.2.1 Description

The homing method is written as a number in object 6098_h and decides whether, on a switch edge (rising/falling), a current threshold for block detection or an index pulse is referenced or in which direction homing starts. Methods that use the index pulse of the encoder lie in the number range 1 to 14, 33 and 34. Methods that do not use the index pulse of the encoder lie between 17 and 30, but are identical to methods 1 to 14 with respect to the travel profiles. These numbers are shown in circles in the following figures. Methods for which no limit switches are used and, instead, travel against a block is to be detected, a minus must be placed before the method number when making the call.

In the following graphics, the negative movement direction is to the left. The *limit switch* is located before the respective mechanical block; the *home switch* is located between the two limit switches. The index pulses come from the connected encoder.

For methods that use homing on block, the same figures apply as for the methods with limit switch. Because nothing is different aside from the missing limit switches, the same figures are used. For the figures here, the limit switches must be replaced with a mechanical block.

6.5.2.2 Homing on block

Homing on block currently only functions in *closed loop* mode.

"Homing on block" functions like every homing method with the difference that instead of a limit switch, a block (limit stop) is used for positioning. Two settings are to be made here:

1. Current level: In object $203A_h:01$, the current level is defined above which movement against the block is detected.
2. Blocking duration: In object $203A_h:02$, the duration during which the motor moves against the block is set.

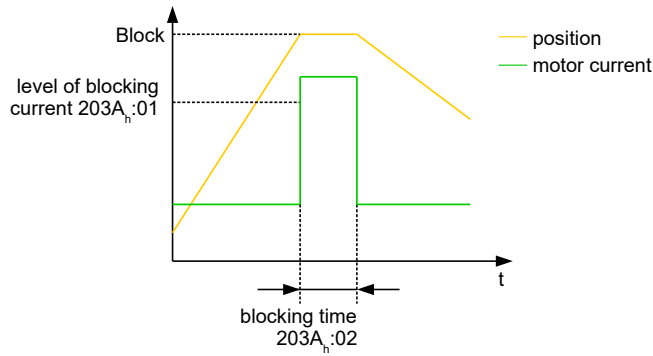

6.5.2.3 Overview of methods

Methods 1 to 14 as well as 33 and 34 use the index pulse of the encoder.

Methods 17 to 32 are identical to methods 1 to 14 with the difference that only limit or home switches are used for referencing and not the index pulse.

- Methods 1 to 14 use an index pulse.
- Methods 17 to 30 do not use an index pulse.
- Methods 33 and 34 reference only to the next index pulse.
- Method 35 references to the current position.

The following methods can be used for homing on block:

- Methods -1 to -2 and -7 to -14 contain an index pulse
- Methods -17 to -18 and -23 to -30 have no index pulse

6.5.2.4 Methods 1 and 2

Reference to limit switches and index pulse.

Method 1 references to negative limit switch and index pulse:

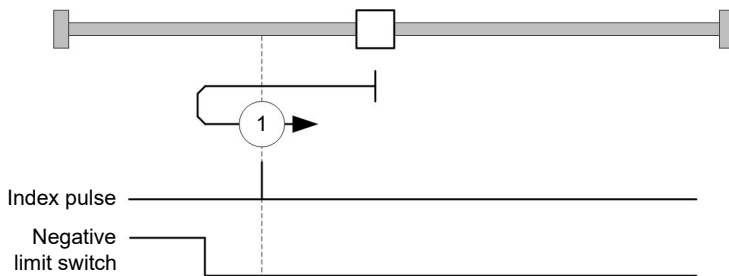

Method 2 references to positive limit switch and index pulse:

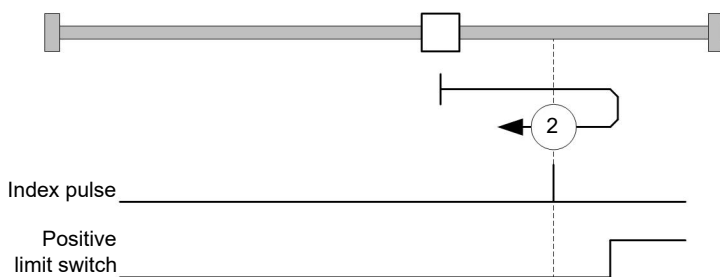

6.5.2.5 Methods 3 to 6

Reference to the switching edge of the home switch and index pulse.

With methods 3 and 4, the left switching edge of the home switch is used as reference:

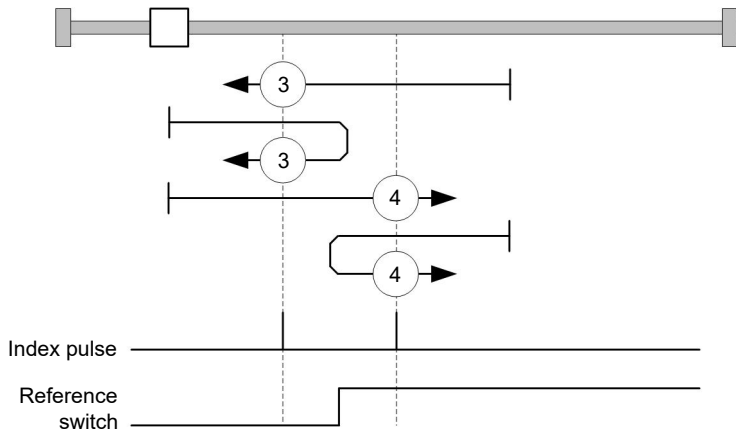

With methods 5 and 6, the right switching edge of the home switch is used as reference:

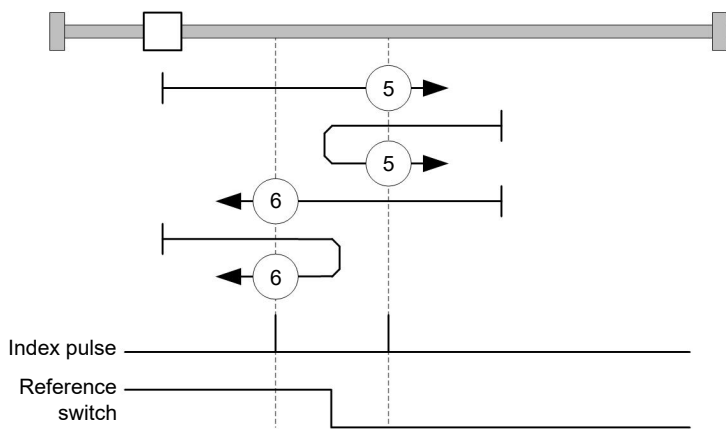

6.5.2.6 Methods 7 to 14

Reference to the home switch and index pulse (with limit switches).

With these methods, the current position relative to the home switch is not important. With method 10, for example, referencing is always performed to the index pulse to the right of the right edge of the home switch.

Methods 7 to 10 take the positive limit switch into account:

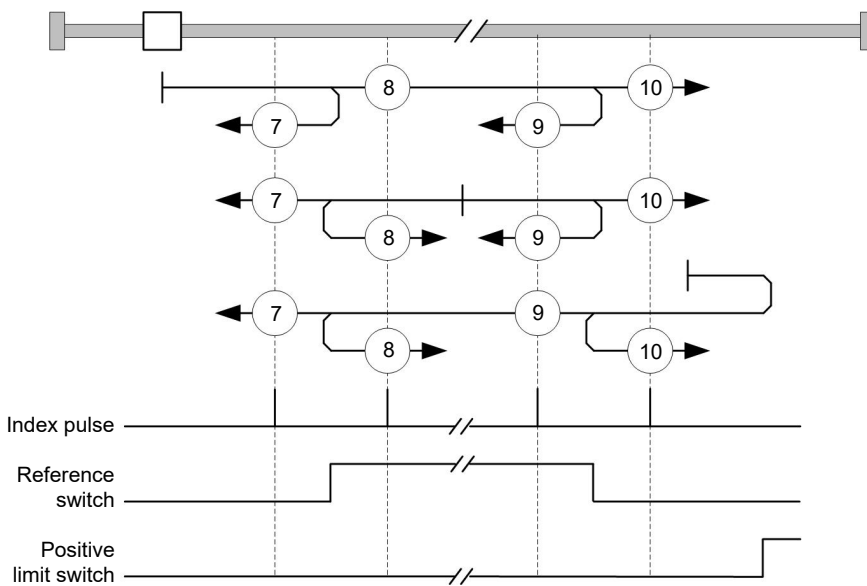

Methods 11 to 14 take the negative limit switch into account:

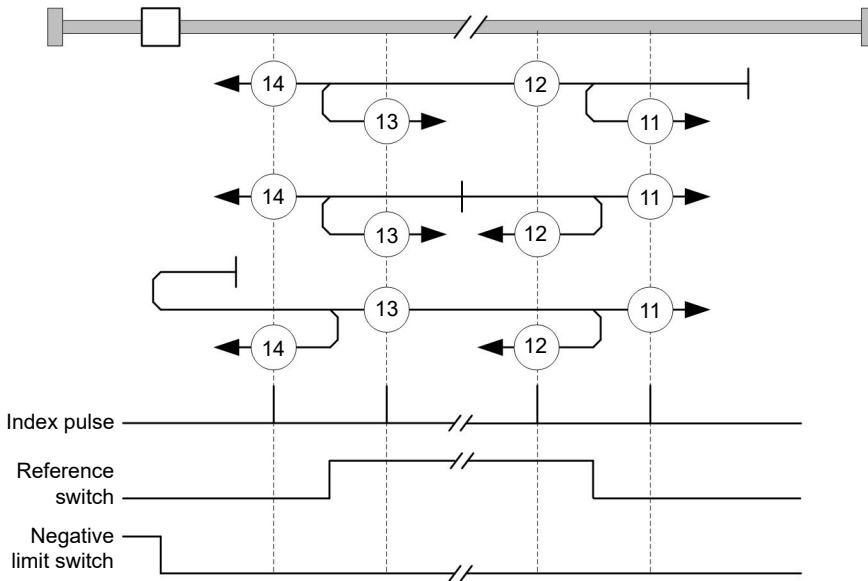

6.5.2.7 Methods 17 and 18

Reference to the limit switch without the index pulse.

Method 17 references to the negative limit switch:

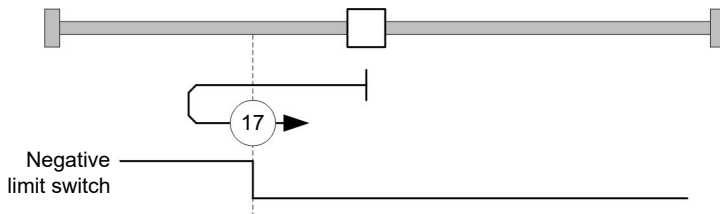

Method 18 references to the positive limit switch:

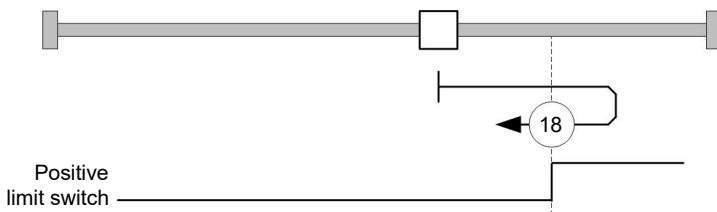

6.5.2.8 Methods 19 to 22

Reference to the switching edge of the home switch without the index pulse.

With methods 19 and 20 (equivalent to methods 3 and 4), the left switching edge of the home switch is used as reference:

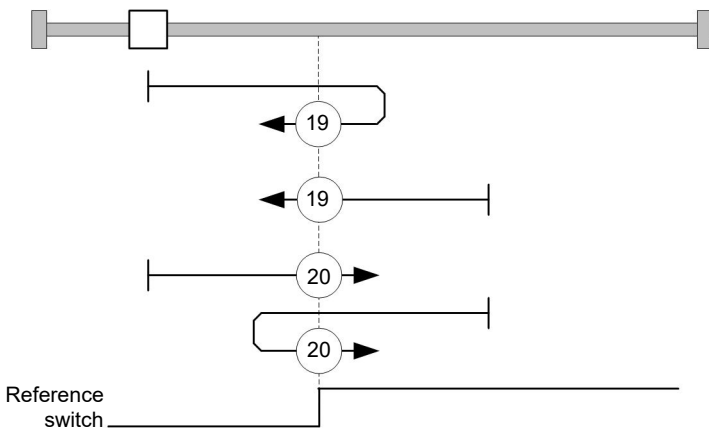

With methods 21 and 22 (equivalent to methods 5 and 6), the right switching edge of the home switch is used as reference:

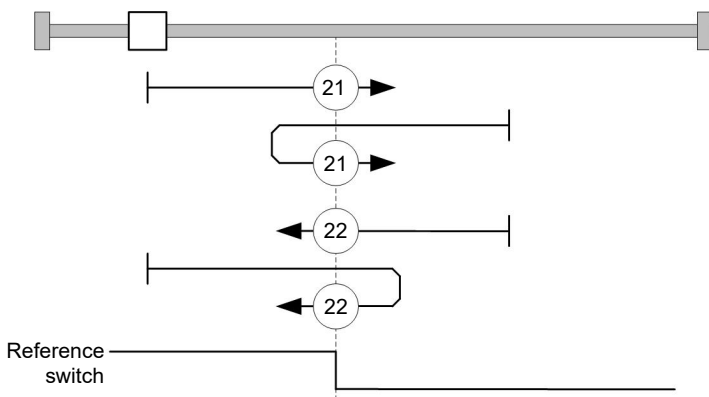

6.5.2.9 Methods 23 to 30

Reference to the home switch without the index pulse (with limit switches).

With these methods, the current position relative to the home switch is not important. With method 26, for example, referencing is always performed to the index pulse to the right of the right edge of the home switch.

Methods 23 to 26 take the positive home switch into account:

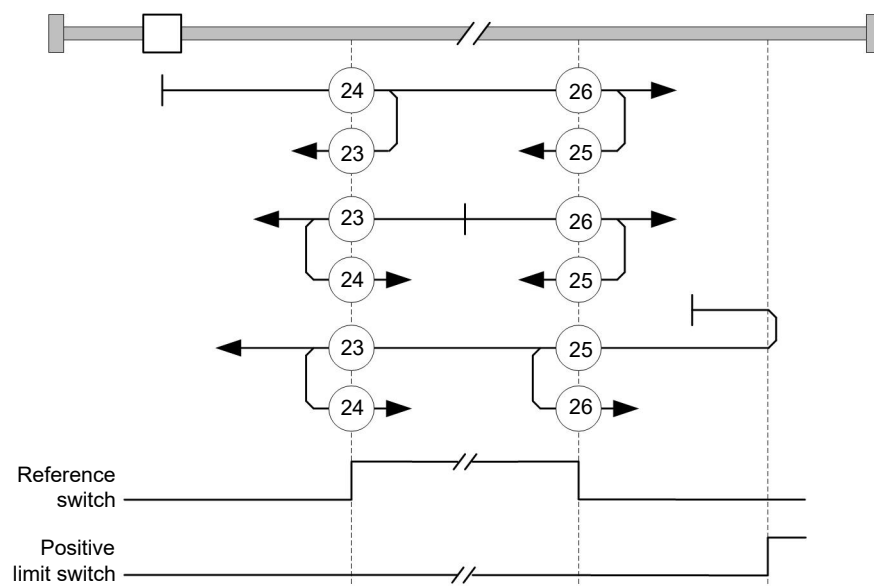

Methods 27 to 30 take the negative home switch into account:

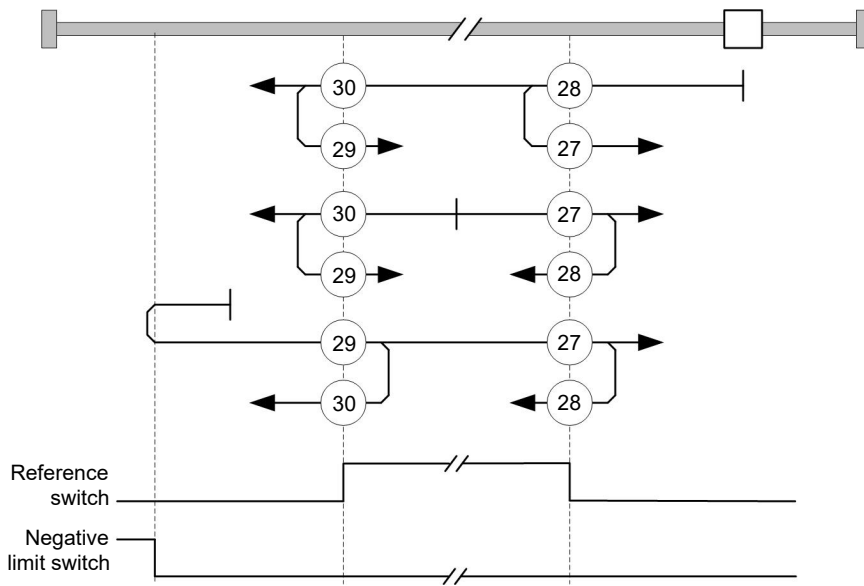

6.5.2.10 Methods 33 and 34

Reference to the next index pulse.

With these methods referencing is only performed to the respective subsequent index pulse:

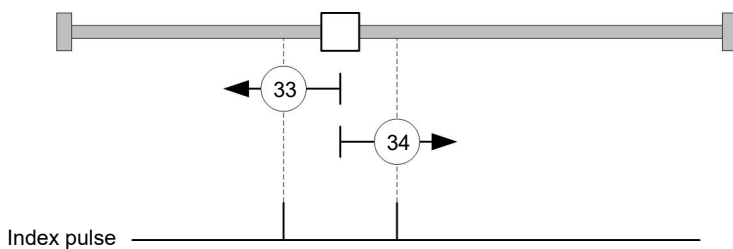

6.5.2.11 Method 35

References to the current position.

NOTICE

i For homing mode 35, it is not necessary to switch the *CiA 402 Power State Machine* to the "Operation enabled" state. When energizing the motor windings in *open-loop* mode, it is thereby possible to prevent the current position from not being exactly 0 after Homing Mode 35.

6.6 Interpolated Position Mode

6.6.1 Overview

6.6.1.1 Description

Interpolated position mode is used to synchronize multiple axes. For this purpose, a higher-level controller performs the ramp and path calculation and passes the respective demand position, at which the axis is to be located at a certain time, to the controller. The controller interpolates between these intermediate position points.

6.6.1.2 Synchronization with the SYNC object

For interpolated position mode, it is necessary that the controller synchronizes with the SYNC object (depending on the fieldbus). This SYNC object is to be sent by the higher-level controller in regular intervals. Synchronization occurs as soon as the controller is switched to the *Operational* NMT mode.



NOTICE

Where possible, it is recommended that a time interval of the *SYNC object* be used.

6.6.2 Activation

To activate the mode, the value "7" must be set in object `6060h` (Modes Of Operation) (see "CiA 402 Power State Machine").

6.6.3 Controlword

The following bits in object `6040h` (controlword) have a special function:

- Bit 4 activates the interpolation when it is set to "1".
- Bit 8 (Halt): If this bit is set to "1", the motor stops. On a transition from "1" to "0", the motor accelerates with the set start ramp to the target speed. On a transition from "0" to "1", the motor brakes and comes to a standstill. The braking deceleration is dependent here on the setting of the "Halt Option Code" in object `605Dh`.

6.6.4 Statusword

The following bits in object `6041h` (statusword) have a special function:

- Bit 10: Target position reached: This bit is set to "1" if the target position was reached (if the halt bit in the controlword is "0") or the axis has speed 0 (if the halt bit in the last control word was "1").
- Bit 12 (IP mode active): This bit is set to "1" if interpolation is active.
- Bit 13 (Following Error): This bit is set in *closed loop* mode if the following error is greater than the set limits (`6065h` (Following Error Window) and `6066h` (Following Error Time Out)).

6.6.5 Use

The controller follows a linearly interpolated path between the current position and the preset target position. The (next) target position must be written in record `60C1h:01h`.

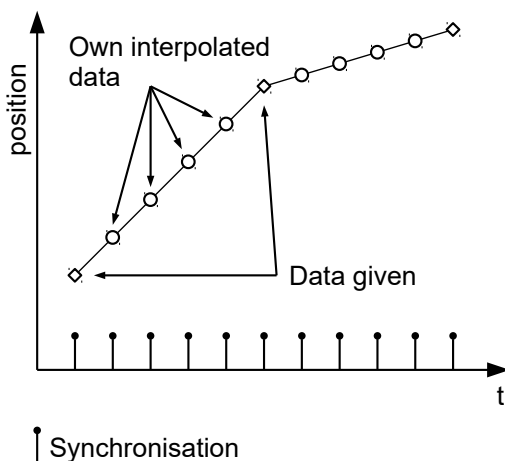

In the current implementation, only

- linear interpolation
- and a target position

are supported.

6.6.6 Setup

The following setup is necessary:

- `60C2h:01h`: Time between two passed target positions in ms.

- **60C4_h:06_h**: This object is to be set to "1" to be able to modify the target position in object **60C1_h:01_h**.
- **6081_h** (Profile Velocity): Maximum speed with which the position is to be approached
- **6084_h** (Profile Deceleration): Desired braking deceleration during braking
- **60C6_h**: (Max Deceleration): The maximum allowed braking deceleration
- To be able to turn the motor, the *power state machine* is to be set to the *Operation enabled* state (see [CiA 402 Power State Machine](#)).

6.6.7 Operation

After setting up, the task of the higher-level controller is to write the target positions to object **60C1_h:01_h** in time.

6.7 Cyclic Synchronous Position

6.7.1 Overview

6.7.1.1 Description

In this mode, the controller receives an absolute position preset via the fieldbus at fixed time intervals (referred to in the following as a *cycle*). The controller then no longer calculates any ramps, but rather only follows the presets.

The target position is transferred cyclically (via *PDO*). Bit 4 in the controlword does not need to be set (unlike the [Profile Position](#) mode).



NOTICE

The target is absolute and, thus, independent of how often it was sent per *cycle*.

6.7.1.2 Synchronization with the SYNC object

To achieve smooth movement, the controller should synchronize with the SYNC object (depending on the field bus). This SYNC object is to be sent by the higher-level controller in regular intervals. Synchronization occurs as soon as the controller is switched to the *Operational* NMT mode.



NOTICE

Where possible, it is recommended that a time interval of the *SYNC object* be used for transfer of the target position.

6.7.1.3 Activation

To activate the mode, the value "8" must be set in object **6060_h** (Modes Of Operation) (see "[CiA 402 Power State Machine](#)").

6.7.1.4 Controlword

In this mode, the bits of controlword **6040_h** have no special function.

6.7.1.5 Statusword

The following bits in object **6041_h** (statusword) have a special function:

| Bit | Value | Description |
|-----|-------|---|
| 8 | 0 | The controller is not in sync with the fieldbus |
| 8 | 1 | The controller is in sync with the fieldbus |
| 10 | 0 | Reserved |

| Bit | Value | Description |
|-----|-------|--|
| 10 | 1 | Reserved |
| 12 | 0 | Controller does not follow the target; the preset of <u>607A_h</u> (Target Position) is ignored |
| 12 | 1 | Controller follows the target; object <u>607A_h</u> (Target Position) is used as the input for position control. |
| 13 | 0 | No following error |
| 13 | 1 | Following error |

Bit 11: Limit exceeded: The demand position is above or below the limit values set in 607D_h.

6.7.2 Object entries

The following objects are necessary for controlling this mode:

- 607A_h (Target Position): This object must be written cyclically with the position set value.
- 607B_h (Position Range Limit): This object contains the preset for an overrun or underrun of the position specification.
- 607D_h (Software Position Limit): This object defines the limitations within which the position specification (607A_h) must be located.
- 6065_h (Following Error Window): This object specifies a tolerance corridor in both the positive and negative direction from the set specification. If the actual position is outside of this corridor for longer than the specified time (6066_h), a following error is reported.
- 6066_h (Following Error Time Out): This object specifies the time range in milliseconds. If the actual position is outside of the position corridor (6065_h) for longer than this time range, a following error is triggered.
- 6085_h (Quick-Stop Deceleration): This object contains the braking deceleration for the case that a quick-stop is triggered.
- 605A_h (Quick-Stop Option Code): This object contains the option that is to be executed in the event of a quick-stop.
- 60C2_h:01_h (Interpolation Time Period): This object specifies the time of a *cycle*; a new set value must be written in 607A_h in these time intervals.
The following applies here: cycle time = value of 60C2_h:01_h * 10^{value of 60C2:02} seconds.
- 60C2_h:02_h (Interpolation Time Index): This object specifies the time basis of the cycles. Currently, only value 60C2_h:02_h=-3 is supported; this yields a time basis of 1 millisecond.
- 60B0_h (Position Offset): Offset for the position set value in user-defined units
- 60B1_h (Velocity Offset): Offset for the speed set value in user-defined units
- 60B2_h (Torque Offset): Offset for the torque set value in tenths of a percent

The following objects can be read in this mode:

- 6064_h (Position Actual Value)
- 606C_h (Velocity Actual Value)
- 60F4_h (Following Error Actual Value)

6.8 Cyclic Synchronous Velocity

6.8.1 Overview

6.8.1.1 Description

In this mode, the controller passes a speed preset via the fieldbus at fixed time intervals (referred to in the following as a *cycle*). The controller then no longer calculates any ramps, but rather only follows the presets.

6.8.1.2 Activation

To activate the mode, the value "9" must be set in object 6060_h (Modes Of Operation) (see "CiA 402 Power State Machine").

6.8.1.3 Controlword

In this mode, the bits of controlword 6040_h have no special function.

6.8.1.4 Statusword

The following bits in object 6041_h (statusword) have a special function:

| Bit | Value | Description |
|-----|-------|--|
| 8 | 0 | The controller is not in sync with the fieldbus |
| 8 | 1 | The controller is in sync with the fieldbus |
| 10 | 0 | Reserved |
| 10 | 1 | Reserved |
| 12 | 0 | Controller does not follow the target; the preset of <u>60FE_h</u> (Target Velocity) is ignored |
| 12 | 1 | Controller follows the target; object <u>60FE_h</u> (Target Velocity) is used as the input for position control. |
| 13 | 0 | Reserved |
| 13 | 1 | Reserved |

6.8.2 Object entries

The following objects are necessary for controlling this mode:

- 60FE_h (Target Velocity): This object must be written cyclically with the speed set value.
- 6085_h (Quick-Stop Deceleration): This object contains the braking deceleration for the case that a quick-stop is triggered (see "CiA 402 Power State Machine").
- 605A_h (Quick-Stop Option Code): This object contains the option that is to be executed in the event of a quick-stop (see "CiA 402 Power State Machine").
- 6080_h (Max Motor Speed): Maximum speed
- 60C2_h:01_h (Interpolation Time Period): This object specifies the time of a *cycle*; a new set value must be written in 60FE_h in these time intervals.
The following applies here: cycle time = value of 60C2_h:01_h * 10^{value of 60C2:02} seconds.
- 60C2_h:02_h (Interpolation Time Index): This object specifies the time basis of the cycles. Currently, only value 60C2_h:02_h=-3 is supported; this yields a time basis of 1 millisecond.
- 60B1_h (Velocity Offset): Offset for the speed set value in user-defined units
- 60B2_h (Torque Offset): Offset for the torque set value in tenths of a percent

The following objects can be read in this mode:

- 606C_h (Velocity Actual Value)
- 607E_h (Polarity)

6.9 Cyclic Synchronous Torque

6.9.1 Overview

6.9.1.1 Description

In this mode, the controller passes an absolute torque preset via the fieldbus at fixed time intervals (referred to in the following as a *cycle*). The controller then no longer calculates any ramps, but rather only follows the presets.



NOTICE

This mode only functions if closed loop is activated, see also Commissioning closed loop.

6.9.1.2 Activation

To activate the mode, the value "10" must be set in object 6060_h (Modes Of Operation) (see "CiA 402 Power State Machine").

6.9.1.3 Controlword

In this mode, the bits of controlword 6040_h have no special function.

6.9.1.4 Statusword

The following bits in object 6041_h (statusword) have a special function:

| Bit | Value | Description |
|-----|-------|--|
| 8 | 0 | The controller is not in sync with the fieldbus |
| 8 | 1 | The controller is in sync with the fieldbus |
| 10 | 0 | Reserved |
| 10 | 1 | Reserved |
| 12 | 0 | Controller does not follow the target; the preset of <u>6071_h</u> (Target Torque) is ignored |
| 12 | 1 | Controller follows the target; object <u>6071_h</u> (Target Torque) is used as the input for position control. |
| 13 | 0 | Reserved |
| 13 | 1 | Reserved |

6.9.2 Object entries

The following objects are necessary for controlling this mode:

- 6071_h (Target Torque): This object must be written cyclically with the torque set value and is to be set relative to 6072_h.
- 6072_h (Max Torque): Describes the maximum permissible torque.
- 6073_h (Max Current):
Maximum current. The minimum of 6073_h and 6072_h is used as limit for the torque in 6071_h.
- 6080_h (Max Motor Speed): Maximum speed
- 60C2_h:01_h (Interpolation Time Period): This object specifies the time of a *cycle*; a new set value must be written in 6071_h in these time intervals.
The following applies here: cycle time = value of 60C2_h:01_h * 10^{value of 60C2:02} seconds.
- 60C2_h:02_h (Interpolation Time Index): This object specifies the time basis of the cycles. Currently, only value 60C2_h:02_h=-3 is supported; this yields a time basis of 1 millisecond.
- 60B2_h (Torque Offset): Offset for the torque set value in tenths of a percent

The following objects can be read in this mode:

- 606C_h (Velocity Actual Value)
- 6074_h (Torque Demand)

6.10 Clock-direction mode

6.10.1 Description

In clock-direction mode, the motor is operated via two inputs by a higher-level positioning controller with clock and direction signal. On each clock signal, the motor moves one step in the direction corresponding to the direction signal.



NOTICE

This mode is not available with product variants PD1-...-65-....

6.10.2 Activation

To activate the mode, the value "-1" (or "FF_h") must be set in object 6060_h (Modes Of Operation) (see "CiA 402 Power State Machine").

6.10.3 General

The following data apply for every subtype of the clock-direction mode:

- The maximum frequency of the input pulse is 1 MHz; the ON pulse should not be less than 200 ns.

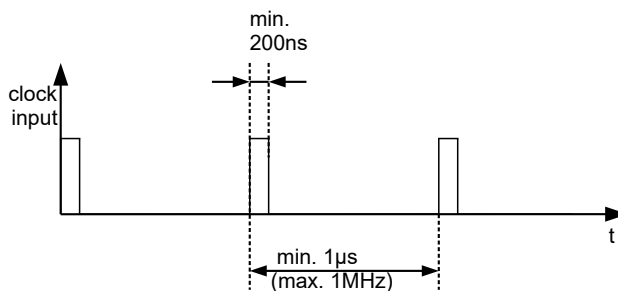

- The demand position resulting from the input pulses is updated cyclically; the cycle time corresponds to the Interpolation Time Period (60C2_h). The input pulses that arrive within a cycle are collected and buffered in the controller.
- The steps are scaled using objects 2057_h and 2058_h. The following formula applies here:

$$\text{step width per pulse} = \frac{2057_h}{2058_h}$$

The "step size per pulse" value is set to 128 (2057_h=128 and 2058_h=1) ex works, which corresponds to a quarter step per pulse. A full step is the value "512", a half step per pulse corresponds to "256", etc.

NOTICE



For a stepper motor with 50 pole pairs, 200 full steps correspond to one mechanical revolution of the motor shaft.

In *clock-direction mode*, the BLDC motors are also handled as stepper motors by the controller. This means that for a BLDC motor with, e.g., 3 pole pairs, 12 (=4*3) full steps correspond to one revolution.

NOTICE



If there is a change of direction, a time of at least 35 μs must elapse before the new clock signal is applied.

6.10.4 Statusword

The following bits in object `6041h` (statusword) have a special function:

- Bit 13 (Following Error): This bit is set in *closed loop* mode if the following error is greater than the set limits (`6065h` (Following Error Window) and `6066h` (Following Error Time Out)).

6.10.5 Subtypes of the clock-direction mode

6.10.5.1 Clock-direction mode (TR mode)

To activate the mode, object `205Bh` must be set to the value "0" (factory settings).

In this mode, the pulses must be preset via the clock input; the signal of the direction input specifies the direction of rotation here (see following graphic).

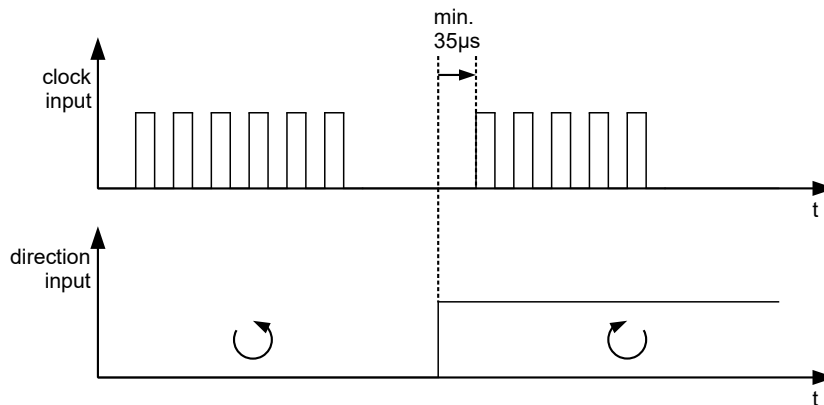

6.10.5.2 Right / left rotation mode (CW / CCW mode)

To activate the mode, object `205Bh` must be set to the value "1".

In this mode, the input that is used decides the direction of rotation (see following graphic).

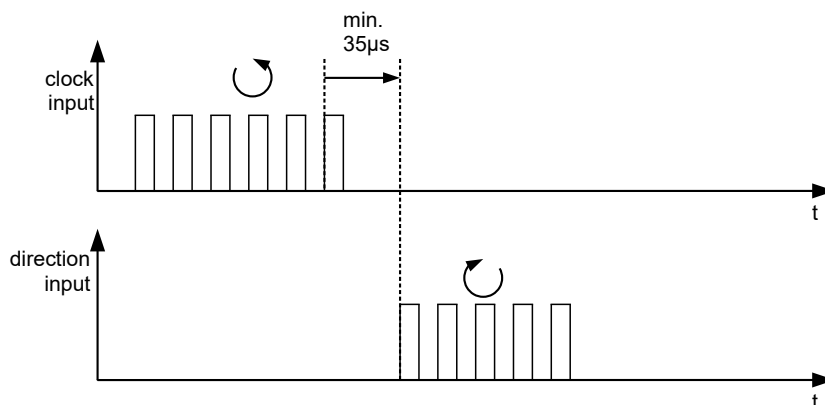

6.11 Auto setup

6.11.1 Description

To determine a number of parameters related to the motor and the connected sensors (encoders/Hall sensors), an *auto setup* is performed. Closed-Loop operation requires a successfully completed *auto setup*. For details, see the corresponding section in chapter Commissioning.

6.11.2 Activation

To activate the mode, the value "-2" ("FE_h") must be set in object 6060_h (Modes Of Operation) (see CiA 402 Power State Machine).

6.11.3 Controlword

The following bits in object 6040_h (controlword) have a special function:

- Bit 4 starts a travel command. This is carried out on a transition from "0" to "1".

6.11.4 Statusword

The following bits in object 6041_h (statusword) have a special function:

- Bit 10: Indexed: indicates whether (= "1") or not (= "0") an encoder index was found.
- Bit 12: Aligned: this bit is set to "1" after *auto setup* has concluded

7 Special functions

7.1 Digital inputs and outputs

This product is equipped with digital inputs and outputs. You can find the exact number for the given product variant in chapter [Pin assignment](#).

In [323Ah User Pin Settings](#), you configure the hardware as follows:

- Subindex 01_h: Here, you define the level for the inputs/outputs:
 - Value "0": 5 V
 - Value "1": 24 V (inputs) or +UB (outputs)



NOTICE

Use for the inputs a voltage that is smaller than the operating voltage +UB.

- Subindex 02_h: Here, you define the wiring for the digital inputs:
 - Value "0" (Pull-Down): High level when 5/24 V at Pin.
 - Value "1" (Pull-Up): High level without external voltage at Pin.

7.1.1 Digital inputs

7.1.1.1 Overview



NOTICE

For digital inputs with 5 V, the length of the supply lines must not exceed 3 meters.



NOTICE

The digital inputs are sampled once per millisecond. Signal changes at the input less than one millisecond in duration are not processed.

7.1.1.2 Computation of the inputs

Object [60FD_h](#) (Digital Inputs) contains a summary of the inputs and the special functions. The current status of the inputs is likewise read out from object [324Ah Inputs](#) (including Hall sensors and incremental encoders, if present).

The following table lists the value of the corresponding bit in the respective object for the inputs depending on the configuration in [323Ah User Pin Settings](#):

| Voltage at pin | Subindex 02 (Pull-Up Enable) | Subindex 01 (Voltage Level Select) | Bit value |
|----------------|---------------------------------|---------------------------------------|-----------|
| n.c | 0 (Pull-Down) | X | 0 |
| GND | 0 (Pull-Down) | X | 0 |
| 5 V | 0 (Pull-Down) | 0 (5 V) | 1 |
| 5 V | 0 (Pull-Down) | 1 (24 V) | 0 |
| 24 V | 0 (Pull-Down) | 1 (24 V) | 1 |
| n.c. | 1 (Pull-Up) | X | 1 |
| GND | 1 (Pull-Up) | X | 0 |

| Voltage at pin | Subindex 02 (Pull-Up Enable) | Subindex 01 (Voltage Level Select) | Bit value |
|----------------|---------------------------------|---------------------------------------|-----------|
| 5 V | 1 (Pull-Up) | 0 (5 V) | 1 |
| 5 V | 1 (Pull-Up) | 1 (24 V) | 0 |
| 24 V | 1 (Pull-Up) | 1 (24 V) | 1 |

7.1.1.3 Special functions

The firmware evaluates the following bits in `60FDh`:

- Bit 0: Negative limit switch (see [Limitation of the range of motion](#))
- Bit 1: Positive limit switch (see [Limitation of the range of motion](#))
- Bit 2: Home switch (see [Homing](#))
- Bit 3: Interlock (see [interlock function](#))

You define the assignment of the bits to the pins with the *Input Routing*.

7.1.1.4 Input Routing

Principle

To perform the assignment of the inputs more flexibly, there is a mode called *Input Routing Mode*. This assigns a signal of a source to a bit in object `60FDh`.

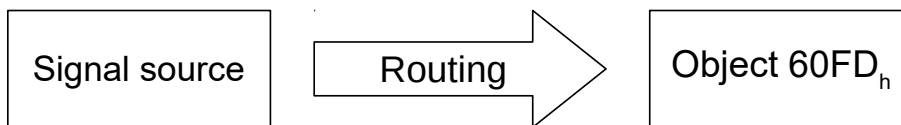

Routing

Object `3242h` determines which signal source is routed to which bit of `60FDh`. Subindex `01h` of `3242h` determines bit 0, subindex `02h` determines bit 1, and so forth. The signal sources and their numbers can be found in the following lists.

| Number | | |
|--------|-----|--------------------|
| dec | hex | Signal source |
| 00 | 00 | Signal is always 0 |
| 01 | 01 | physical input 1 |
| 02 | 02 | Physical input 2 |
| 03 | 03 | Physical input 3 |
| 04 | 04 | Physical input 4 |
| 05 | 05 | Physical input 5 |
| 06 | 06 | Physical input 6 |
| 07 | 07 | Physical input 7 |
| 08 | 08 | Physical input 8 |
| 09 | 09 | Physical input 9 |
| 10 | 0A | physical input 10 |
| 11 | 0B | Physical input 11 |
| 12 | 0C | physical input 12 |
| 13 | 0D | Physical input 13 |
| 14 | 0E | Physical input 14 |

| Number | | |
|--------|-----|-----------------------|
| dec | hex | Signal source |
| 15 | 0F | Physical input 15 |
| 16 | 10 | Physical input 16 |
| 65 | 41 | Hall input "U" |
| 66 | 42 | Hall input "V" |
| 67 | 43 | Hall input "W" |
| 68 | 44 | Encoder input "A" |
| 69 | 45 | Encoder input "B" |
| 70 | 46 | Encoder input "Index" |
| 81 | 51 | Negative block |
| 82 | 52 | Positive block |
| 90 | 5A | Analog input |

The following table describes the inverted signals of the previous table.

| Number | | |
|--------|-----|--------------------------------|
| dec | hex | Signal source |
| 128 | 80 | Signal is always 1 |
| 129 | 81 | Inverted physical input 1 |
| 130 | 82 | Inverted physical input 2 |
| 131 | 83 | Inverted physical input 3 |
| 132 | 84 | Inverted physical input 4 |
| 133 | 85 | Inverted physical input 5 |
| 134 | 86 | Inverted physical input 6 |
| 135 | 87 | Inverted physical input 7 |
| 136 | 88 | Inverted physical input 8 |
| 137 | 89 | Inverted physical input 9 |
| 138 | 8A | Inverted physical input 10 |
| 139 | 8B | Inverted physical input 11 |
| 140 | 8C | Inverted physical input 12 |
| 141 | 8D | Inverted physical input 13 |
| 142 | 8E | Inverted physical input 14 |
| 143 | 8F | Inverted physical input 15 |
| 144 | 90 | Inverted physical input 16 |
| 193 | C1 | Inverted Hall input "U" |
| 194 | C2 | Inverted Hall input "V" |
| 195 | C3 | Inverted Hall input "W" |
| 196 | C4 | Inverted encoder input "A" |
| 197 | C5 | Inverted encoder input "B" |
| 198 | C6 | Inverted encoder input "Index" |

Example

Input 1 is to be routed to bit 16 of object `60FDh`:

The number of the signal source for input 1 is "1". The routing for bit 16 is written in $3242_h:11_h$.

Hence, object $3242_h:11_h$ must be set to the value "1".

7.1.1.5 Interlock function

The interlock function is a release that you control via bit 3 in $60FD_h$. If this bit is set to "1", the motor can move. If the bit is set to "0", the controller switches to the error state and the action stored in $605E_h$ is executed.

To activate the interlock function, you must switch on the special function by setting bit 3 in $3240:01_h$ to "1".

Use *Input Routing* to define which signal source is routed to bit 3 of $60FD_h$ and is to control the interlock function.

Example

Input 4 is to be routed to bit 3 of object $60FD_h$ to control the interlock function. A low level is to result in an error state.

1. To route input 4 to bit 3, set $3242_h:04_h$ to "4".

7.1.2 Digital outputs

7.1.2.1 Outputs

The outputs are controlled via object $60FE_h$. Here, output 1 corresponds to bit 16 in object $60FE_h$, output 2 corresponds to bit 17, etc., as with the inputs. The outputs with special functions are entered in the firmware in the lower bits 0 to 15. The only bit assigned at the present time is bit 0, which controls the motor brake.

7.1.2.2 Wiring

The digital outputs are push-pull. The voltage at the pin in the high state is either 5 V ($323A_h:01_h=0$) or +Up ($323A_h:01_h=1$). The current should not exceed 50 mA.

7.1.2.3 Output Routing

Principle

The "Output Routing Mode" assigns an output a signal source; a control bit in object $60FE_h:01_h$ switches the signal on or off.

The source is selected with $3252_h:01$ to n in the "high byte" (bit 15 to bit 8). The assignment of a control bit from object $60FE_h:01_h$ is performed in the "low byte" (bit 7 to bit 0) of $3252_h:01_h$ to n (see following figure).

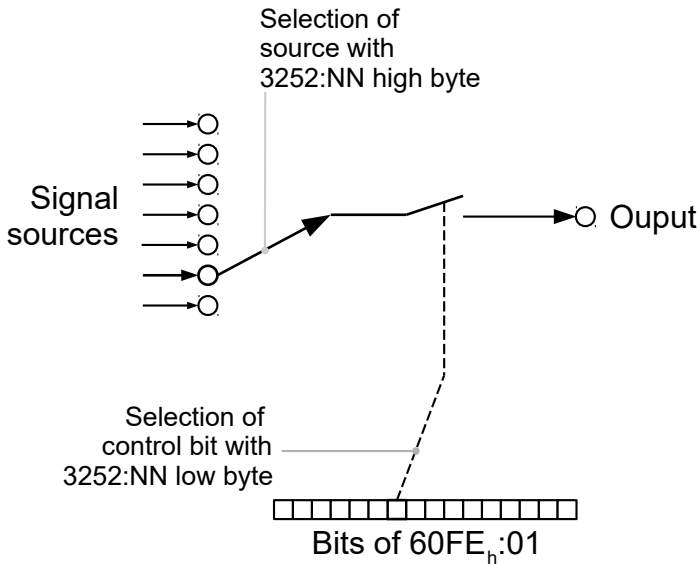

Routing

The subindex of object 3252_h determines which signal source is routed to which output. The output assignments are listed in the following:

NOTICE



The maximum output frequency of the PWM output (software PWM) is 2 kHz. All other outputs can only produce signals up to 500 Hz.

Subindices $3252_h:01_h$ to $0n_h$ are 16 bits wide, whereby the high byte selects the signal source (e. g., the PWM generator) and the low byte determines the control bit in object $60FE_h:01$.

Bit 7 of $3252_h:01_h$ to $0n_h$ inverts the controller from object $60FE_h:01$. Normally, value "1" in object $60FE_h:01_h$ switches on the signal; if bit 7 is set, the value "0" switches on the signal.

| Number in 3252:01 to 0n | |
|-------------------------|--|
| 00XX _h | Output is always "1" |
| 01XX _h | Output is always "0" |
| 02XX _h | Encoder signal (6063 _h) with frequency divider 1 |
| 03XX _h | Encoder signal (6063 _h) with frequency divider 2 |
| 04XX _h | Encoder signal (6063 _h) with frequency divider 4 |
| 05XX _h | Encoder signal (6063 _h) with frequency divider 8 |
| 06XX _h | Encoder signal (6063 _h) with frequency divider 16 |
| 07XX _h | Encoder signal (6063 _h) with frequency divider 32 |
| 08XX _h | Encoder signal (6063 _h) with frequency divider 64 |
| 09XX _h | Position Actual Value (6064 _h) with frequency divider 1 |
| 0AXX _h | Position Actual Value (6064 _h) with frequency divider 2 |
| 0BXX _h | Position Actual Value (6064 _h) with frequency divider 4 |
| 0CXX _h | Position Actual Value (6064 _h) with frequency divider 8 |
| 0DXX _h | Position Actual Value (6064 _h) with frequency divider 16 |
| 0EXX _h | Position Actual Value (6064 _h) with frequency divider 32 |
| 0FXX _h | Position Actual Value (6064 _h) with frequency divider 64 |

NOTICE



On any change of the "encoder signal" (6063_h) or the current position (6064_h in user-defined units) by an increment, a pulse is output at the digital input (for frequency divider 1). Take this into account when selecting the frequency divider and the unit, especially when using sensors with low resolution (such as Hall sensors).

Example

The encoder signal (6063_h) is to be applied to output 1 with a frequency divider 4. The output is to be controlled with bit 5 of object $60FE:01$.

- $3250_h:08_h = 1$ (activate routing)
- $3252_h:02_h = 0405_h$ ($04XX_h + 0005_h$)
- $04XX_h$: Encoder signal with frequency divider 4
- 0005_h : Selection of bit 5 of $60FE:01$

The output is switched on by setting bit 5 in object $60FE:01$.

Example

The brake PWM signal is to be applied to output 2. Because the automatic brake control uses bit 0 of $60FE:01_h$, this should be used as control bit.

- $3250_h:08_h = 1$ (activate routing)
- $3252_h:03_h = 1080_h$ ($=10XX_h + 0080_h$). Where:
 - $10XX_h$: Brake PWM signal
 - 0080_h : Selection of the inverted bit 0 of object $60FE:01$

7.2 I²t Motor overload protection

7.2.1 Description

NOTICE



For stepper motors, only the rated current is specified, not a maximum current. No liability is therefore assumed when using I²t with stepper motors.

The goal of I²t motor overload protection is to protect the motor from damage and, at the same time, operate it normally up to its thermal limit.

This function is only available if the controller is in the closed loop mode (bit 0 of object 3202_h must be set to "1").

7.2.2 Object entries

The following objects affect I²t motor overload protection:

- 2031_h : Max Motor Current – specifies the maximum permissible motor current in mA.
- $203B_h:1_h$ Motor Rated Current – specifies the rated current in mA.
- 6073_h Max Current – specifies the maximum current in tenths of a percent of the set rated current.
- $203B_h:2_h$ Maximum Duration Of Peak Current – specifies the maximum duration of the maximum current in ms.

The following objects indicate the current state of I^2t :

- $203B_h:3_h$ Threshold – specifies the limit in A^2ms that determines whether the maximum current or rated current is switched to.
- $203B_h:4_h$ CalcValue – specifies the calculated value in A^2ms that is compared with the threshold for setting the current.
- $203B_h:5_h$ LimitedCurrent – shows the momentary current value in mA that was set by I^2t .
- $203B_h:6_h$ Status:
 - Value = "0": I^2t deactivated
 - Value = "1": I^2t activated

7.2.3 Activation

Closed loop must be activated, (bit 0 of object 3202_h set to "1", see also chapter [Closed-Loop](#)).

To activate the mode, you must appropriately specify the four object entries mentioned above (2031_h , 6073_h , $203B_h:1_h$, $203B_h:2_h$). This means that the maximum current must be greater than the rated current and a time value for the maximum duration of the maximum current must be entered. If these conditions are not met, the I^2t functionality remains deactivated.

7.2.4 Function of I^2t

From the specification of rated current, maximum current and maximum duration of the maximum current, an I^2t_{Lim} is calculated.

The motor can run with maximum current until the calculated I^2t_{Lim} is reached. The current is then immediately reduced to the rated current. The maximum current is limited by the maximum motor current (2031_h).

The relationships are illustrated again in the following diagrams.

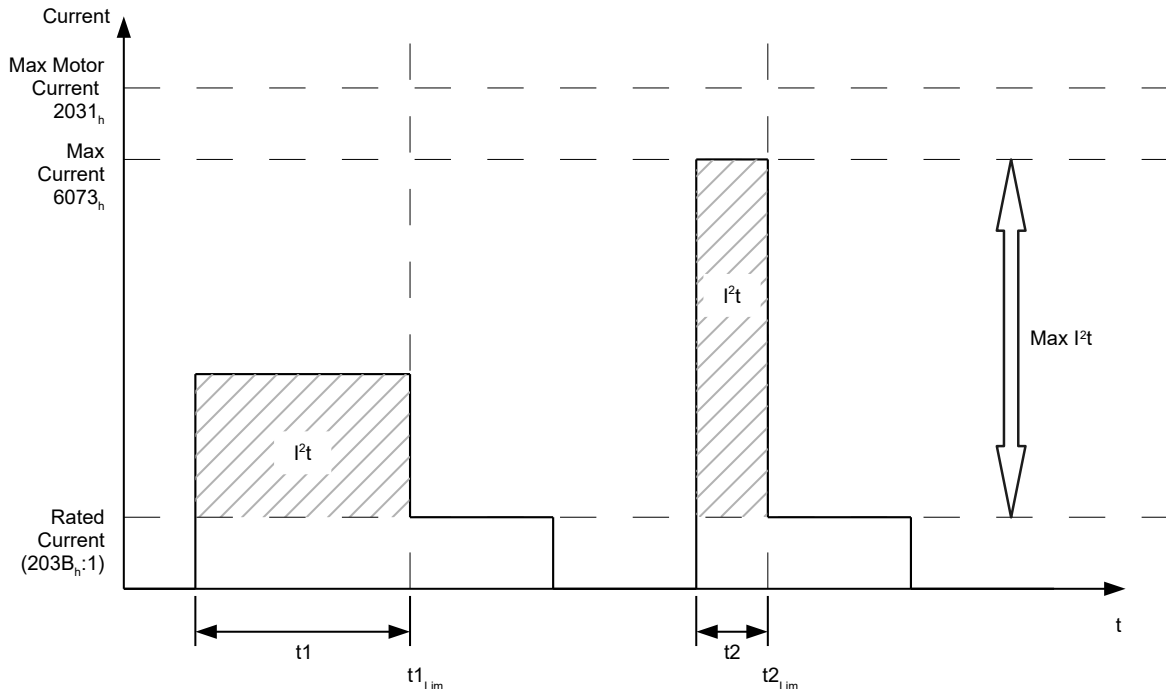

In the first section, t_1 , the current value is higher than the rated current. At time t_{1Lim} , I^2t_{Lim} is reached and the current is limited to the rated current. A current that corresponds to the maximum current then occurs for a period of time t_2 . Hence, the value for I^2t_{Lim} is reached more quickly than in time t_1 .

7.3 Saving objects

NOTICE



Improper use of the function can result in it no longer being possible to start the controller. Therefore, carefully read the entire chapter before using the function.

7.3.1 General

Many objects in the object dictionary can be saved and then automatically reloaded the next time the controller is switched on or reset. Furthermore, the saved values are also retained following a firmware update.

Only entire collections of objects (referred to in the following as *categories*) can be saved together; individual objects cannot be saved.

An object can be assigned one of the following *categories*:

- Communication: Parameters related to external interfaces, such as PDO configuration etc.
- Application: Parameters related to operating modes.
- User: Parameters that are written and read by the customer/user only and are ignored by the controller firmware.
- Drive: Parameters related to the motor and the sensors (BLDC/Stepper, *closed/open-loop...*). Some are set and saved by auto setup.
- Tuning: Parameters related to motor and encoder that are set either by auto setup or that can be found in the data sheets, e.g., pole pairs and maximum current.
- CANopen: Parameters related to CANopen communication

If an object is not assigned one of these *categories*, it cannot be saved, e.g., statusword and all objects whose value is dependent on the current state of the controller.

The objects in each *category* are listed below. In chapter [Description of the object dictionary](#), the corresponding *category* for each object is also specified.

7.3.2 Category: Communication

- 1005_h: COB-ID Sync
- 1006_h: Communication Cycle Period
- 1007_h: Synchronous Window Length
- 100C_h: Guard Time
- 100D_h: Live Time Factor
- 1014_h: COB-ID EMCY
- 1016_h: Consumer Heartbeat Time
- 1017_h: Producer Heartbeat Time
- 1019_h: Synchronous Counter Overflow Value
- 1029_h: Error Behavior
- 1400_h: Receive PDO 1 Communication Parameter
- 1401_h: Receive PDO 2 Communication Parameter
- 1402_h: Receive PDO 3 Communication Parameter
- 1403_h: Receive PDO 4 Communication Parameter
- 1404_h: Receive PDO 5 Communication Parameter
- 1405_h: Receive PDO 6 Communication Parameter
- 1406_h: Receive PDO 7 Communication Parameter
- 1407_h: Receive PDO 8 Communication Parameter
- 1600_h: Receive PDO 1 Mapping Parameter
- 1601_h: Receive PDO 2 Mapping Parameter
- 1602_h: Receive PDO 3 Mapping Parameter

- 1603_h: Receive PDO 4 Mapping Parameter
- 1604_h: Receive PDO 5 Mapping Parameter
- 1605_h: Receive PDO 6 Mapping Parameter
- 1606_h: Receive PDO 7 Mapping Parameter
- 1607_h: Receive PDO 8 Mapping Parameter
- 1800_h: Transmit PDO 1 Communication Parameter
- 1801_h: Transmit PDO 2 Communication Parameter
- 1802_h: Transmit PDO 3 Communication Parameter
- 1803_h: Transmit PDO 4 Communication Parameter
- 1804_h: Transmit PDO 5 Communication Parameter
- 1805_h: Transmit PDO 6 Communication Parameter
- 1806_h: Transmit PDO 7 Communication Parameter
- 1807_h: Transmit PDO 8 Communication Parameter
- 1A00_h: Transmit PDO 1 Mapping Parameter
- 1A01_h: Transmit PDO 2 Mapping Parameter
- 1A02_h: Transmit PDO 3 Mapping Parameter
- 1A03_h: Transmit PDO 4 Mapping Parameter
- 1A04_h: Transmit PDO 5 Mapping Parameter
- 1A05_h: Transmit PDO 6 Mapping Parameter
- 1A06_h: Transmit PDO 7 Mapping Parameter
- 1A07_h: Transmit PDO 8 Mapping Parameter
- 1F80_h: NMT Startup
- 2102_h: Fieldbus Module Control

7.3.3 Category: Application

- 2034_h: Upper Voltage Warning Level
- 2035_h: Lower Voltage Warning Level
- 2036_h: Open Loop Current Reduction Idle Time
- 2037_h: Open Loop Current Reduction Value/factor
- 2038_h: Brake Controller Timing
- 203A_h: Homing On Block Configuration
- 203D_h: Torque Window
- 203E_h: Torque Window Time Out
- 203F_h: Max Slippage Time Out
- 2057_h: Clock Direction Multiplier
- 2058_h: Clock Direction Divider
- 205B_h: Clock Direction Or Clockwise/Counter Clockwise Mode
- 2084_h: Bootup Delay
- 2290_h: PDI Control
- 2300_h: NanoJ Control
- 2410_h: NanoJ Init Parameters
- 2800_h: Bootloader And Reboot Settings
- 3212_h: Motor Drive Flags
- 321A_h: Current Controller Parameters
- 321B_h: Velocity Controller Parameters
- 321C_h: Position Controller Parameters
- 321D_h: Feedforward
- 321E_h: Voltage Limit
- 323A_h: User Pin Settings
- 3241_h: Digital Input Position Capture
- 3242_h: Digital Input Routing
- 3243_h: Home Switch Position Capture

- 3250_h: Digital Outputs Control
- 3252_h: Digital Output Routing
- 325A_h: Outputs
- 3273_h: Generic SPI Hardware Configuration
- 3274_h: Generic SPI Mosi Data
- 3321_h: Analog Input Offsets
- 3322_h: Analog Input Numerators
- 3323_h: Analog Input Denominators
- 3700_h: Deviation Error Option Code
- 3701_h: Limit Switch Error Option Code
- 4013_h: HW Configuration
- 4015_h: Special Drive Modes
- 6007_h: Abort Connection Option Code
- 6040_h: Controlword
- 6042_h: VI Target Velocity
- 6046_h: VI Velocity Min Max Amount
- 6048_h: VI Velocity Acceleration
- 6049_h: VI Velocity Deceleration
- 604A_h: VI Velocity Quick Stop
- 604C_h: VI Dimension Factor
- 605A_h: Quick Stop Option Code
- 605B_h: Shutdown Option Code
- 605C_h: Disable Operation Option Code
- 605D_h: Halt Option Code
- 605E_h: Fault Reaction Option Code
- 6060_h: Modes Of Operation
- 6065_h: Following Error Window
- 6066_h: Following Error Time Out
- 6067_h: Position Window
- 6068_h: Position Window Time
- 606D_h: Velocity Window
- 606E_h: Velocity Window Time
- 606F_h: Velocity Threshold
- 6070_h: Velocity Threshold Time
- 6071_h: Target Torque
- 6072_h: Max Torque
- 607A_h: Target Position
- 607B_h: Position Range Limit
- 607C_h: Home Offset
- 607D_h: Software Position Limit
- 607E_h: Polarity
- 607F_h: Max Profile Velocity
- 6081_h: Profile Velocity
- 6082_h: End Velocity
- 6083_h: Profile Acceleration
- 6084_h: Profile Deceleration
- 6085_h: Quick Stop Deceleration
- 6086_h: Motion Profile Type
- 6087_h: Torque Slope
- 6091_h: Gear Ratio
- 6092_h: Feed Constant
- 6096_h: Velocity Factor
- 6097_h: Acceleration Factor

- 6098_h: Homing Method
- 6099_h: Homing Speed
- 609A_h: Homing Acceleration
- 60A2_h: Jerk Factor
- 60A4_h: Profile Jerk
- 60A8_h: SI Unit Position
- 60A9_h: SI Unit Velocity
- 60B0_h: Position Offset
- 60B1_h: Velocity Offset
- 60B2_h: Torque Offset
- 60C1_h: Interpolation Data Record
- 60C2_h: Interpolation Time Period
- 60C4_h: Interpolation Data Configuration
- 60C5_h: Max Acceleration
- 60C6_h: Max Deceleration
- 60E8_h: Additional Gear Ratio - Motor Shaft Revolutions
- 60E9_h: Additional Feed Constant - Feed
- 60ED_h: Additional Gear Ratio - Driving Shaft Revolutions
- 60EE_h: Additional Feed Constant - Driving Shaft Revolutions
- 60F2_h: Position Option Code
- 60F8_h: Max Slippage
- 60FE_h: Digital Outputs
- 60FE_h: Target Velocity

7.3.4 Category: User

- 2701_h: Customer Storage Area

7.3.5 Category: Movement

- 3202_h: Motor Drive Submode Select
- 320D_h: Torque Of Inertia Factor
- 6073_h: Max Current
- 6080_h: Max Motor Speed

7.3.6 Category: Tuning

- 2030_h: Pole Pair Count
- 2031_h: Max Motor Current
- 203B_h: I2t Parameters
- 3203_h: Feedback Selection
- 3380_h: Feedback Sensorless
- 33A0_h: Feedback Incremental A/B/I 1
- 6075_h: Motor Rated Current
- 608F_h: Position Encoder Resolution
- 6090_h: Velocity Encoder Resolution
- 60E6_h: Additional Position Encoder Resolution - Encoder Increments
- 60EB_h: Additional Position Encoder Resolution - Motor Revolutions

7.3.7 Category: CANopen

- 2005_h: CANopen Baudrate
- 2007_h: CANopen Config
- 2009_h: CANopen NodeID

7.3.8 Starting the save process

CAUTION!



Uncontrolled motor movements!

Control may be affected while saving. Unforeseen reactions can result.

- ▶ The motor must be at a standstill before starting the saving process. The motor must not be started while saving.

NOTICE



- Saving may take a few seconds. Never interrupt the power supply while saving. The state of the saved objects is otherwise undefined.
- Always wait until the controller has signaled that the save process has been successfully completed with the value "1" in the corresponding subindex in object `1010h`.

There is a subindex in object `1010h` for each *category*. To save all objects of this *category*, the value "65766173_h" must be written in the subindex. ¹ The controller signals the end of the save process by overwriting the value with a "1".

The following table shows which subindex of object `1010h` is responsible for which *category*.

| Subindex | Category |
|-----------------|--|
| 01 _h | All categories with the exception of 0A _h (CANopen) |
| 02 _h | Communication |
| 03 _h | Application |
| 04 _h | User |
| 05 _h | Movement |
| 06 _h | Tuning |
| 0A _h | CANopen |

7.3.9 Discarding the saved data

If all objects or one *category* of saved objects is to be deleted, value "64616F6C_h" must be written in object `1011h`. ²

The following subindices correspond to a *category* here:

| Subindex | Category |
|-----------------|---|
| 01 _h | All categories (reset to factory settings) with the exception of 06 _h (Tuning) and 0A _h (CANopen) |
| 02 _h | Communication |
| 03 _h | Application |
| 04 _h | User |
| 05 _h | Movement |
| 06 _h | Tuning |

¹ This corresponds to the decimal of 1702257011_d or the ASCII string `save`.

² This corresponds to the decimal of 1684107116_d or the ASCII string `load`.

| Subindex | Category |
|-----------------|----------|
| 0A _h | CANopen |

The saved objects are subsequently discarded; the change does not take effect until after the controller is restarted. You can restart the controller by entering the value "746F6F62_h" in 2800_h:01_h.

NOTICE



- Objects of *category* 06_h (Tuning) are determined by Auto setup and are not reset when resetting to factory settings with subindex 01_h (thereby making it unnecessary to again perform an auto setup). You can reset these objects with subindex 06_h.
- Objects of *category* 0A_h (CANopen) are not reset with subindex 01_h.

7.3.10 Verifying the configuration

Object 1020_h can be used to verify the configuration. It acts as a modification marker similar to common text editors: as soon as a file is modified in the editor, a marker (usually an asterisk) is added.

The entries of object 1020_h can be written with a date and time and then saved together with all other savable objects with 1010_h:01.

The entries of 1020_h are reset to "0" as soon as a savable object (including 1010_h:0x_h, except for 1010_h:01_h and 1020_h) is written.

The following sequence makes verification possible:

1. An external tool or master configures the controller.
2. The tool or master sets the value in object 1020_h.
3. The tool or master activates the saving of all objects 1010_h:01_h = 65766173_h. The date and time in object 1020_h are also saved.

After the controller is restarted, the master can check the value in 1020_h:01_h and 1020:01_h. If one of the values is "0", the object dictionary was changed after the saved values were loaded. If the date or time in 1020 does not correspond to the expected value, objects were probably saved with values other than those that were expected.

7.4 Generic SPI

The controller can communicate with external devices via this SPI interface, e.g. port expanders or displays. The corresponding pins are only available with product variants PD1-...-OF-....

NOTICE



The used SPI peripheral must support a clock frequency of at least 164 KHz.

The settings of the SPI interface are located in object 3273_h:01_h (Generic SPI Hardware Configuration):

- Bit 0 (Clock Phase):
 - Value = "0": Data transfer begins with the first clock edge after *Chip Select* was pulled to low.
 - Value = "1": Data transfer begins with the second clock edge after *Chip Select* was pulled to low.
- Bit 1 (Clock Polarity): With this bit, you can invert the polarity of the clock signal. The value 0 means the level remains on Low if the clock is idling.
- Bits 2 to 4 (baud rate): You set the clock frequency here:
 - 000_b: 21 MHz
 - 001_b: 10.5 MHz

- 010_b: 5.25 MHz
- 011_b: 2625 KHz
- 100_b: 1312.5 KHz
- 101_b: 656.25 KHz
- 110_b: 328.125 KHz
- 111_b: 164.0625 KHz
- Bit 10 (CS Polarity): With this bit, you can invert the polarity of the *Chip Select*. Value 0 means that the level remains on High if the signal is idling.

The data are sent/received via the following objects:

- 3274_h (Generic SPI Mosi Data):
 - Subindex 1 to 1F_h (Generic SPI Mosi Data Byte #1 to #31): You write the data that are to be sent here, divided into up to 31 bytes.
 - Subindex 0 (Length of SPI message to be sent): Then enter the number of bytes here (= subindices) that are to be sent. In the next millisecond cycle, the data are sent and the subindex is reset to the value "0".
- 3275_h (Generic SPI Miso Data): You read the received data here.
 - Subindex 0 (Length of received SPI message): The value tells you how many data bytes (= subindices) were received.
 - Subindex 1 to 1F_h (Generic SPI Miso Data Byte #1 to #31): The data that were received are located here.

8 CANopen

You can address the controller using CANopen. The controller can function in a network as a *slave*.

In this chapter, the services of the CANopen communication structure are described. The CANopen messages are individually broken down.

CANopen references: www.can-cia.org

- *CiA 301 CANopen application layer and communication profile - Application layer and communication profile*, Date: 21.02.2011, Version: 4.2.0
- *CiA 402 Device profile for drives and motion control - Part 1: General definitions*, Date: 14.12.2007, Version: 3.0.0
- *CiA 402 Drives and motion control device profile - Part 2: Operation modes and application data*, Date: 14.12.2007, Version: 3.0
- *CiA 402 Drives and motion control device profile - Part 3: PDO mapping*, Date: 14.12.2007, Version: 3.0
- *CiA 306 Electronic device description - Part 1: Electronic Data Sheet and Device Configuration File*, Date: 08.02.2012, Version: 1.3.5
- *CiA 305 Layer setting services (LSS) and protocols*, Date: 08.05.2013, Version: 3.0.0

8.1 General



TIP

- Only 11-bit CAN-IDs are currently supported.
- With CANopen, the data are always sent over the bus in little-endian format.

8.1.1 CAN message

CAN messages are described in this chapter; these are written in the following format:

583 | 41 09 10 00 1E 00 00 00

183R | DLC=0

The individual messages are written as follows:

- All numbers are written in hexadecimal notation; due to the abbreviated notation, the leading 0x is omitted.
- Normal data message: The CAN-ID is prefixed to the CAN message; in the above example, the ID 583 (i.e., 583_h or 1411_d). The data and the CAN-ID are separated from the data with a pipe character.
- RTR message (remote transmission request): If an R follows the CAN-ID instead of the data, the length of the *DLC* (Download Content) is specified. In the above example, the length of the *DLC* is 0.

8.2 CANopen services

The CANopen stack offers the services listed in the following table; more detailed descriptions can be found in the respective chapters.

| Default CAN-ID | Service | Description in |
|---------------------------|-------------------------------|---|
| 000 _h | Network Management (NMT) | Section Network Management (NMT) |
| 080 _h | Synchronization Object | Section Synchronization object (SYNC) |
| 080 _h +Node-ID | Emergency | Section Emergency Object (EMCY) |
| 180 _h +Node-ID | TX Process Data Objects (PDO) | Section Process Data Object (PDO) |
| 200 _h +Node-ID | RX Process Data Objects (PDO) | |
| 280 _h +Node-ID | TX Process Data Objects (PDO) | |
| 300 _h +Node-ID | RX Process Data Objects (PDO) | |

| Default CAN-ID | Service | Description in |
|---------------------------|-------------------------------|---|
| 380 _h +Node-ID | TX Process Data Objects (PDO) | |
| 400 _h +Node-ID | RX Process Data Objects (PDO) | |
| 480 _h +Node-ID | TX Process Data Objects (PDO) | |
| 500 _h +Node-ID | RX Process Data Objects (PDO) | |
| 580 _h +Node-ID | TX Service Data Objects (SDO) | Section <u>Service Data Object (SDO)</u> |
| 600 _h +Node-ID | RX Service Data Objects (SDO) | |
| 700 _h +Node-ID | BOOT-UP Protocol | Section <u>Boot-Up Protocol</u> |
| 700 _h +Node-ID | Nodeguarding and Heartbeat | Section <u>Heartbeat and Nodeguarding</u> |

8.2.1 Network Management (NMT)

The network management follows a master-slave structure. NMT requires a CANopen device in the network that performs the role of the CANopen master.

All other devices have the role of the NMT slave. Each NMT slave can be addressed via its individual node-ID in the range from [1–127]. NMT services can be used to initiate, start, monitor, reset or stop CANopen devices.

In doing so, the controller follows the state diagram shown in the following figure. The "Initialization" state is only reached after switching on or by sending a "Reset Communication" or "Reset Node" NMT command. The "Pre-Operational" state is automatically activated after initialization.

In object 1F80_h, you can set whether the "Operational" state is automatically switched to afterwards, thereby allowing you to avoid sending an additional NMT command.

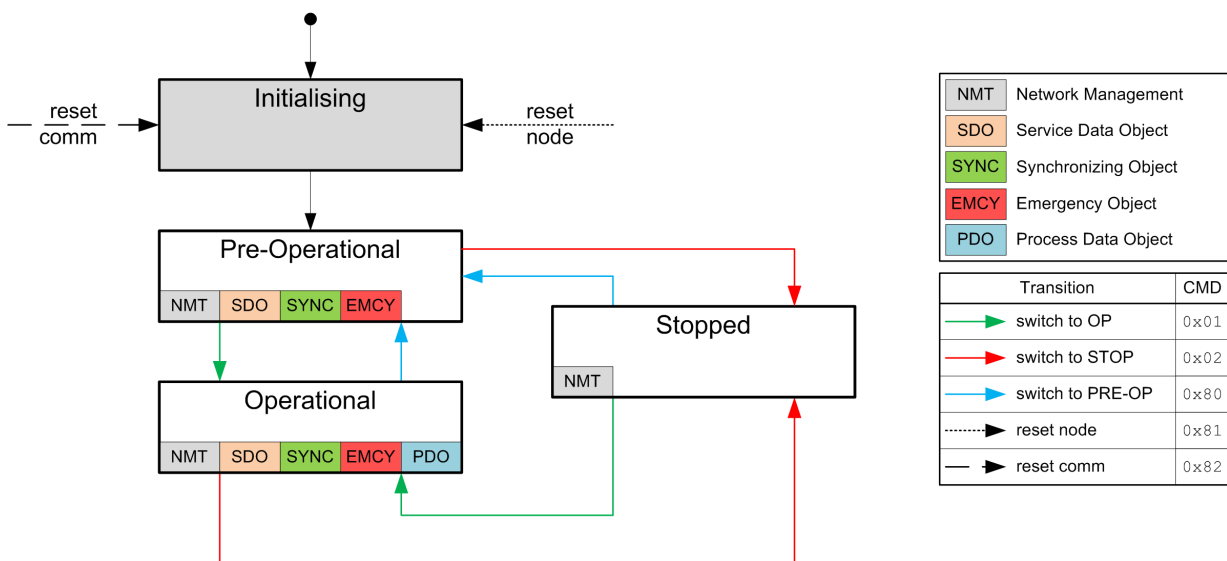

Shown in the following table is an overview of the activity of the services in the respective states.

Note that the *Stopped* state stops communication completely and only permits controller of the NMT state machine.

| Service | Initializing | Pre-Operational | Operational | Stopped |
|---------|--------------|-----------------|-------------|---------|
| PDO | | | Active | |
| SDO | | Active | Active | |
| SYNC | | Active | Active | |
| EMCY | | Active | Active | |
| BOOT-UP | Active | | | |
| NMT | | Active | Active | Active |

The "Network Management" message has CAN-ID 0. A message is always two bytes long and has the following structure:

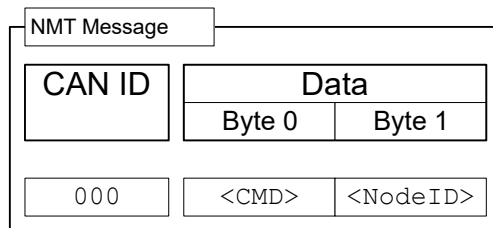

Here, the <CMD> corresponds to one of the following bytes (see also the legend in the figure of the [NMT state diagram](#)):

| <CMD> | Meaning |
|-----------------|---------------------------------------|
| 01 _h | Switch to the "Operational" state |
| 02 _h | Switch to the "Stop" state |
| 80 _h | Switch to the "Pre-Operational" state |
| 81 _h | Reset Node |
| 82 _h | Reset Communication |

Completely restart the controller with the "Reset Node" command. Use the "Reset Communication" command to reset the CANopen settings and restart the communication.

The value for <Node-ID> can be 00_h; in this case, the NMT command applies for all devices on the CAN bus (broadcast). If a number not equal to zero is used, only the device with the corresponding node-ID is addressed.

Example: If all devices on the CAN bus are to be switched to the "Stop" operating state, a broadcast with the "Switch to the Stop state" command can be used. The NMT message is structured as follows:

000 | 02 00

If only the device with node-ID 42 is to be completely restarted, the following CAN message is to be sent:

000 | 01 2A

8.2.2 Synchronization object (SYNC)

The Synchronization object is used to simultaneously validate the time of PDO data for all devices on the bus. The sync message is structured as follows:

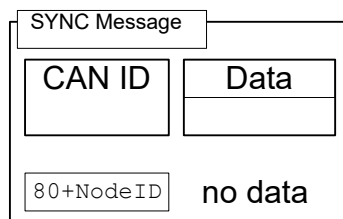

For SYNC operation, transmission mode (Transmission Type) 0 is usually used for the RX-PDOs (data are valid with the next SYNC); for TX-PDOs, a transmission mode between 1 and 240 is selected. (Details: see chapter [Process Data Object \(PDO\)](#)).

After receiving a SYNC message, there is a time window ("synchronous window") within which PDO messages can be sent and received. If the time of the window has elapsed, all devices must stop sending PDOs. The "synchronous window length" can be set in microseconds in object 1007_h:00_h.

A typical CAN-SYNC operation is divided into four phases (see also the following figure):

1. The SYNC message is received. The previously received RX-PDO data are thereby copied to the object dictionary (if present). At that time, the data are also sampled and copied to the TX-PDOs and the sending of these messages initiated.
2. The TX-PDOs are then sent by all slaves on the bus.
3. Afterwards, the PDOs are sent by the CANopen master. After the "synchronous window length" time has elapsed, no further PDOs are permitted.
4. SDO messages can be exchanged at the latest when the "synchronous window" is closed again.

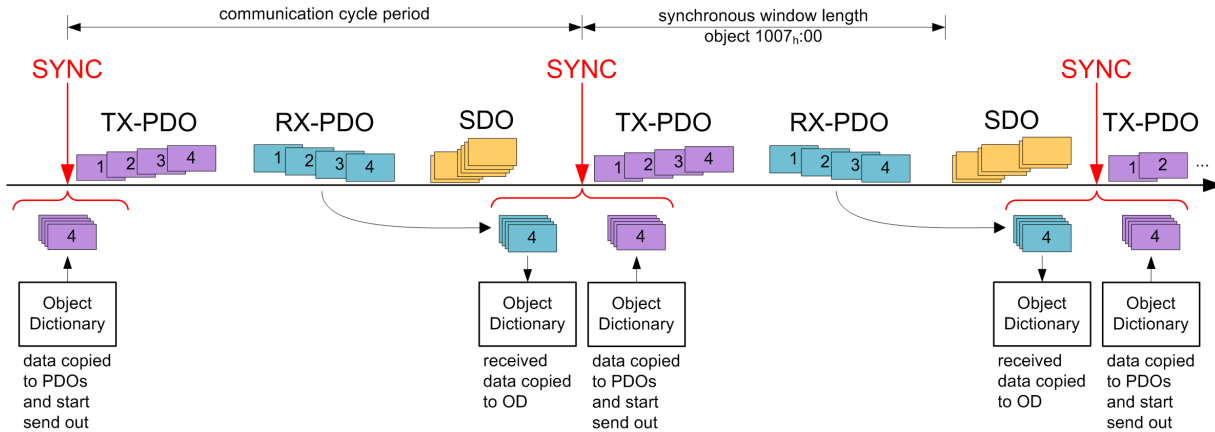

If the *Sync Producer* supports a *Sync Counter*, the sync message receives an additional 1-byte numerical value. This counter is increased by the value "1" per sent sync message and is reset each time the value 1019h Synchronous Counter Overflow Value is reached.

For each TX-PDO, a start value of the *Sync Counter* can be defined in subindex 06_h of the corresponding communication parameter (e.g., in 1800_h:06_h) beginning with which the *slave* is to respond to the sync for the first time and send the PDO. The function is not activated until a value greater than 1 is set in 1019_h.

8.2.3 Emergency Object (EMCY)

A message of type "Emergency" is sent whenever an error occurs in the controller that was not caused by an SDO access. This service is unconfirmed and is sent with CAN-ID 80_h+Node-ID.

The emergency message is structured as follows:

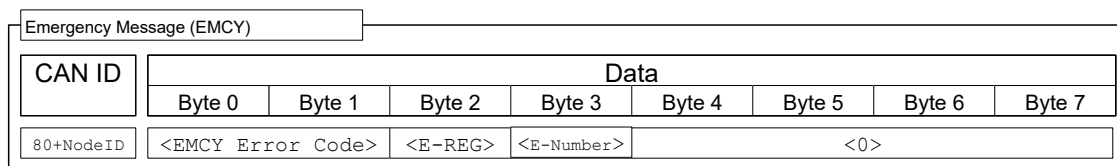

A total of three error codes are transferred here:

- the "Emergency Error Code" (<EMCY Error Code>)
- the content of the "Error Register" object (1001_h), E-REG
- the "Error Number" (E-Number)

8.2.3.1 Error handling

A module for error handling processes all errors that occur internally. Each error is classified into an error class.

Each error that occurs is handled as follows:

1. The bit that belongs to the error in the "Error Register" object (1001_h) is set.
2. Three pieces of information are then written together in the "Pre-defined Error Field" object (1003_h:01):

- The *Emergency Error Code*
- The *Error Register*
- The manufacturer-specific error code

3. If no further errors are pending, the following message is sent:

```
80 + Node-ID | 00 00 E-REG E-Number 00 00 00 00
```

In object `1029h`, you can configure whether and how the controller is to change its *NMT state* in case of an error.

8.2.4 Service Data Object (SDO)

A "Service Data Object" permits read or write access of the object dictionary.

In the following, the owner of the object dictionary is referred to as the "server"; the CAN node – which wants to request or write the data – is referred to as the "client".

An "upload" refers to the reading of a value of an object from the object dictionary; a "download" refers to the writing of a value in the object dictionary. In addition, the following abbreviations are used in the diagrams:

- **<IDX>**: Index of the object that is to be read or written in the object dictionary; the LSB of the index is in byte 1 here. Example: The statusword of the controller has index `6041h`; byte 1 is then written with `41h` and byte 2 with `60h`. With Expedited Transfer, the SDO answer contains the same index as that of the request.
- **<SUBIDX>**: Subindex of the object in the object dictionary from `00h` to `FFh`. With Expedited Transfer, the answer of the SDO message of the controller also contains the subindex of the request.

Because CAN messages of type SDO contain a large amount of metadata, you should only use SDO messages to configure the controller. Should it be necessary to cyclically exchange data during running operation, use CANopen messages of type PDO (see subsection Process Data Object).

The SDO transfers are divided into three types of access:

- "expedited transfer" for transferring objects with up to four bytes.
- "normal transfer" for transferring any number of bytes, whereby each CAN message is confirmed individually.
- "block transfer" is also for any number of bytes; here, a given block of CAN tickets is confirmed at once.

An SDO message is sent to CAN-ID `600h` + node-ID, the answer comes from CAN-ID `580h` + node-ID.

8.2.4.1 Expedited Transfer

This method is used to write (download) or read (upload) values in objects of type (UN)SIGNED8, INTEGER16 oder INTEGER32 in the object dictionary. This service is confirmed, i.e., each access is answered with data, with a confirmation or with an error message.

SDO Download

An expedited SDO message for writing data in the object dictionary of the server is structured as follows:

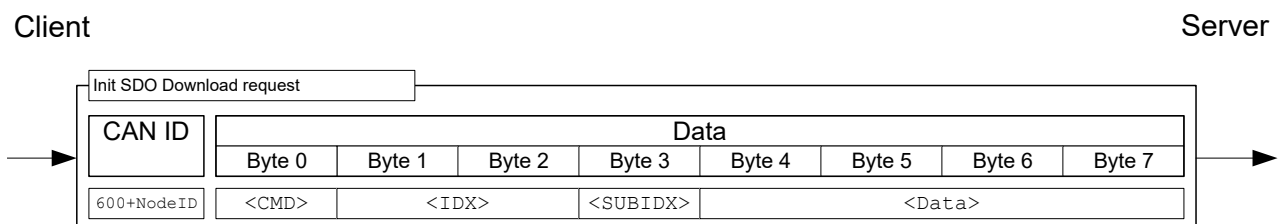

Here, the **<CMD>** byte is dependent on the length of the data that are to be written. **<CMD>** can be one of the following values:

- 1 byte data length: 2F_h
- 2 byte data length: 2B_h
- 3 byte data length: 27_h
- 4 byte data length: 23_h

The <Data> field is written with the data that are to be written; the LSB of the data is entered in byte 4.

The answer from the server is either a confirmation of the write operation or an error message (structure of the messages: see following figure). In the latter case, the reason for the error is also sent with the data (see list of the SDO error messages in section SDO error messages).

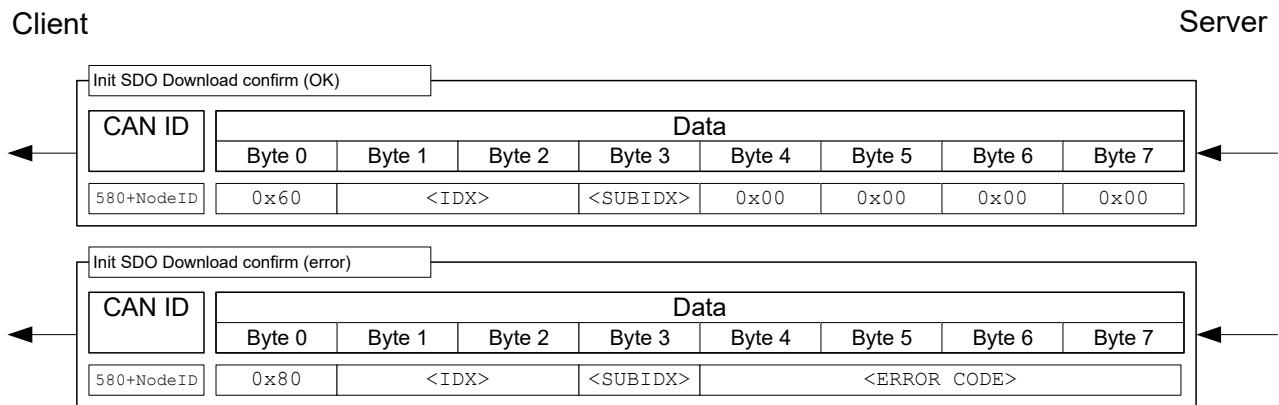

Example: Set object 607A_h:00_h (target position, SIGNED32) to value 3E8_h (=1000_d) of a controller with node-ID 3:

603 | 23 7A 60 00 E8 03 00 00

Where

- Byte 1 (23_h): SDO expedited download, 4 bytes of data (SIGNED32)
- Bytes 2 and 3 (7A_h 60_h): index of object is 607A_h
- Byte 4 (00_h): subindex of object is 00_h
- Bytes 5 to 8 (E8_h 03_h 00_h 00_h): value of object: 000003E8_h

If successful, the controller responds with this message:

583 | 60 7A 60 00 00 00 00 00

SDO upload

A CAN message for reading an object from the object dictionary has the following structure:

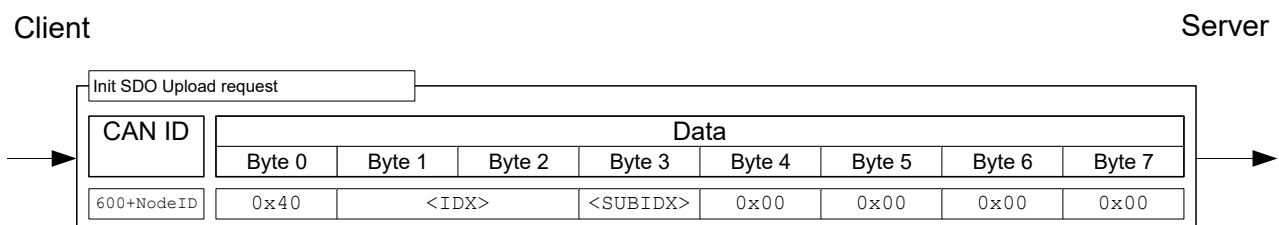

The server responds with one of the following messages.

Client

Server

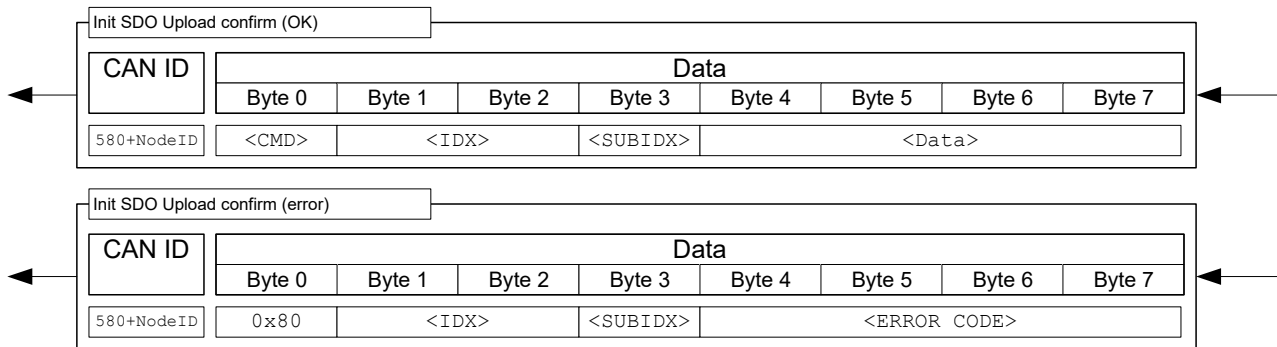

The length of the data is encrypted in the <CMD> of the answer:

| | |
|---------------------|-----------------|
| 1 byte data length: | 4F _h |
| 2 byte data length: | 4B _h |
| 3 byte data length: | 47 _h |
| 4 byte data length: | 43 _h |

The LSB of the data is again in byte 4 here.

In case of an error, the reason for the error is also specified in the data (see list of SDO error messages in [SDO error messages](#)).

Example: To read the "statusword" object (6041_h:00) from the object dictionary, it suffices to send the following message (always 8 bytes):

```
603 | 40 41 60 00 00 00 00 00
```

The controller generally responds with the following message:

```
583 | 4B 41 60 00 40 02 00 00
```

Where

- Byte 1 (4B_h): SDO expedited upload, 2 bytes of data (UNSIGNED16)
- Bytes 2 and 3 (41_h 60_h): index of object is 6041_h
- Byte 4 (00_h): subindex of object is 00_h
- Bytes 5 to 6 (40_h 02_h): value of object: 0240_h
- Bytes 7 to 8 (00_h 2_h h h): empty. An SDO message always consists of 8 bytes.

8.2.4.2 Normal Transfer

Unlike "expedited" CANopen transfer, "normal transfer" is not limited to maximum four bytes. With this type of transfer, the content of multiple messages is grouped together with respect to content; such a block of messages is referred to in the following as a "transfer". Each message within a transfer is confirmed individually here.

NOTICE



If your CANopen master does not support normal transfer, there is another way to access objects of data type String: each string can be read out character by character with an SDO upload to subindex 1 and the following subindices.

SDO upload

Shown in the following figure is the procedure for an "SDO upload" (client requests that the content of an object be sent to it). The transfer is broken down into two phases: an initialization phase and a transfer phase.

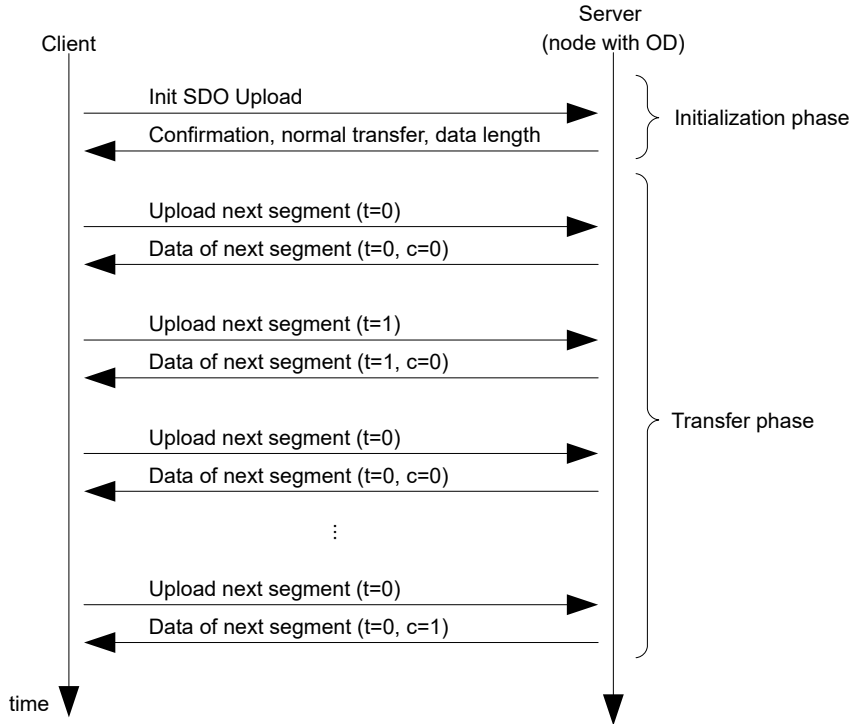

As with an "expedited transfer", the upload begins with the client sending an "Init SDO Update" to the server (see following figure).

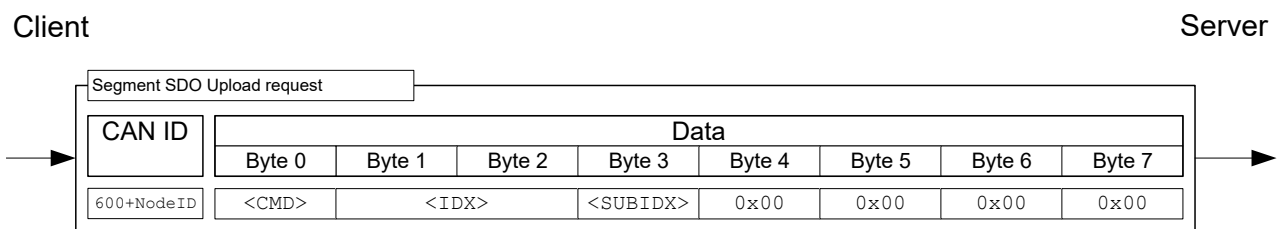

The answer for a "normal transfer" does not contain the quantity of bytes to be received encoded in the <CMD>. It is instead entered in the data range as can be seen in the following figure in the <DATA LENGTH> area.

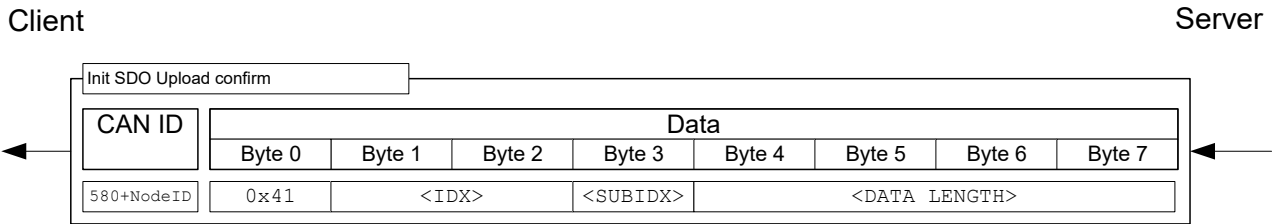

The initialization is thereby concluded; all that remains is the upload of the data. A data packet is requested with the following SDO request:

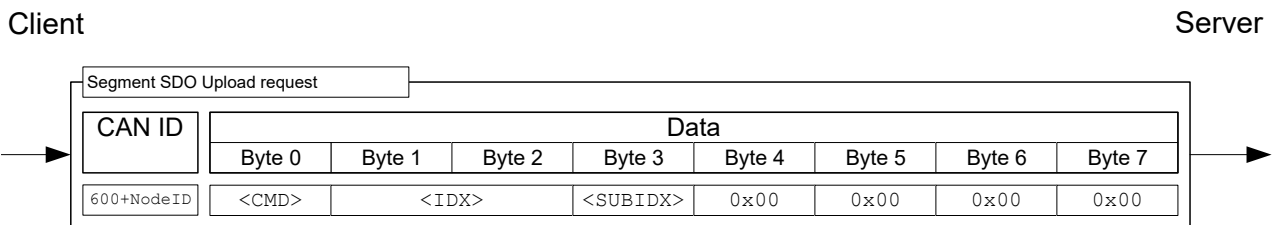

Byte 0 with command <CMD> is structured as follows:

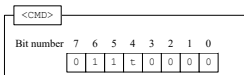

The bit with designation t alternates with each request ("toggle bit"). It begins each transfer with 0, even if the previous transfer was aborted.

The controller responds to the above message with the data, whereby the message is structured as follows:

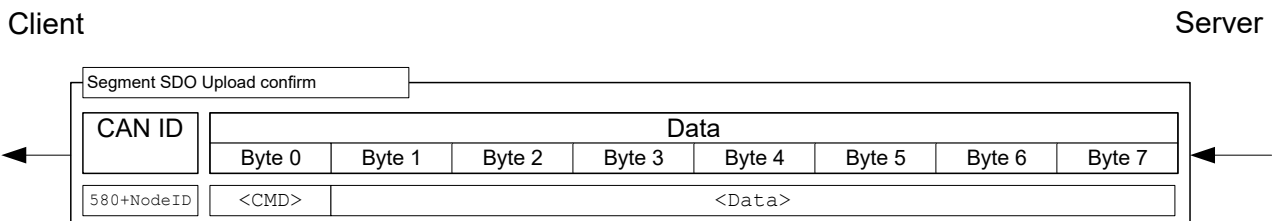

Byte 0 with <CMD> is structured as follows:

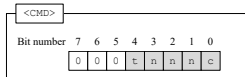

The bits have the following meaning here:

t (toggle bit)

The bit alternates with each message sequence; it does not change within a sequence between "request" and "response".

n (number of bytes)

These three bits specify how many bytes contain *no* data. Example: If bits 2 and 1 are set to 0 and bit 3 is set to 1, then $011_b = 03_d$ bytes are not valid. This, in turn, means that byte 1 to byte 4 contain allowed values and byte 5 to byte 7 should be disregarded.

c (more segments)

If no further SDO segments are sent and this is the last segment, the bit is set to 1.

Example: In this example, the "Manufacturer Software Version" object ($100A_h$) is to be read. The node-ID of the node in this example is 3.

The corresponding SDO message sequence is listed in the following table. The string that is to be read out varies from controller to controller.

| COB-ID | Data | Description |
|------------------|-------------------------|--|
| 603 _h | 40 0A 10 00 00 00 00 00 | Init Upload; Index: 100A _h ; Subindex: 00 |
| 583 _h | 41 0A 10 00 11 00 00 00 | Init Upload; Size: indicated; transfer type: normal; Num of bytes: 17; Index: 100A _h ; Subindex: 00 |
| 603 _h | 60 0A 10 00 00 00 00 00 | Upload Segment Req.; Toggle bit: not set |
| 583 _h | 00 46 49 52 2D 76 31 37 | Upload Segment Conf.; More segments: yes; num of bytes: 7; Toggle bit: not set |
| 603 _h | 70 0A 10 00 00 00 00 00 | Upload Segment Req.; Toggle bit: set |
| 583 _h | 10 34 38 2D 42 35 33 38 | Upload Segment Conf.; More segments: yes; num of bytes: 7; Toggle bit: set |
| 603 _h | 60 0A 10 00 00 00 00 00 | Upload Segment Req.; Toggle bit: not set |
| 583 _h | 09 36 36 32 00 00 00 00 | Upload Segment Conf.; More segments: no (last segment); num of bytes: 3; Toggle bit: not set |

46 49 52 2D 76 31 37 34 38 2D 42 35 33 38 36 36 32

This corresponds to string: "FIR-v1748-B538662"

Aborting the SDO transfer

Both the server and the client are authorized to abort the current transfer. To do this, an "Abort SDO Transfer" must be sent; this is depicted in the following.

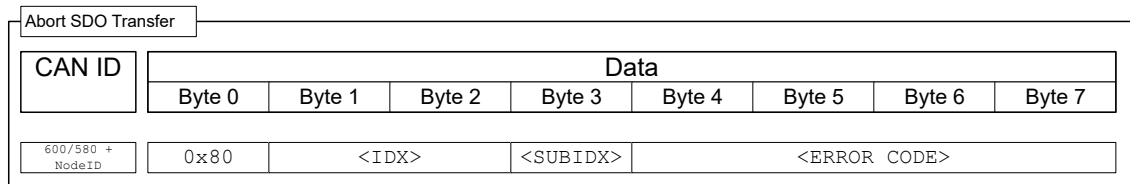

After receiving the message, the SDO transfer is considered ended; the service is not confirmed.

A new SDO transfer must then be started from the very beginning. Transfer of the <ERROR CODE> is optional; the controller does not evaluate the code.

8.2.4.3 SDO error messages

In case of an error, an error number specifying the reason for the error is also sent in the data area.

| Error Code | Description |
|-----------------------|---|
| 05030000 _h | <i>toggle bit not changed</i> : Valid only with "normal transfer" or "block transfer". The bit, which is to alternate after each transfer, did not change its state. |
| 05040001 _h | <i>command specifier unknown</i> : Byte 0 of the data block contains a command that is not allowed. |
| 06010000 _h | <i>unsupported access</i> : If "complete access" was requested via CAN over EtherCAT (CoE) (is not supported.) |
| 06010002 _h | <i>read only entry</i> : An attempt was made to write to a constant or read-only object. |
| 06020000 _h | <i>object not existing</i> : An attempt was made to access a non-existing object (index incorrect). |
| 06040041 _h | <i>object cannot be pdo mapped</i> : An attempt was made to map an object in the PDO for which that is not permissible. |
| 06040042 _h | <i>mapped pdo exceed pdo</i> : If the desired object were to be attached to the PDO mapping, the 8 bytes of the PDO mapping would be exceeded. |
| 06070012 _h | <i>parameter length too long</i> : An attempt was made to write to an object with too much data; for example, with <CMD>=23 _h (4 bytes) to an object of type Unsigned8, <CMD>=2F _h would be correct. |
| 06070013 _h | <i>parameter length too short</i> : An attempt was made to write to an object with too little data; for example, with <CMD>=2F _h (1 byte) to an object of type Unsigned32, <CMD>=23 _h would be correct. |
| 06090011 _h | <i>subindex not existing</i> : An attempt was made to access an invalid subindex of an object; the index, on the other hand, would exist. |
| 06090031 _h | <i>value too great</i> : Some objects are subject to restrictions in the size of the value; in this case, an attempt was made to write an excessively large value to the object. For example, the "Pre-defined error field: Number of errors" object for 1003 _h :00 may only be set to the value "0"; all other numerical values result in this error. |
| 06090032 _h | <i>value too small</i> : Some objects are subject to restrictions in the size of the value. In this case, an attempt was made to write a value that is too small to the object. |
| 08000000 _h | <i>general error</i> : General error that does not fit in any other category. |
| 08000022 _h | <i>data cannot be read or stored in this state</i> : The parameters of the PDOs may only be changed in the "Stopped" or "Pre-Operational" state. Write access of objects 1400 _h to 1407 _h , 1600 _h to 1607 _h , 1800 _h to 1807 _h and 1A00 _h to 1A07 _h is not permissible in the "Operational" state. |

8.2.5 Process Data Object (PDO)

A message that only contains process data is referred to as a "Process Data Object" (PDO). The PDO is intended for data that need to be exchanged cyclically.

The idea behind a PDO message is to remove all additional information (index, subindex and data length) from a CAN message and to only fill the CAN message with data. The source and target information for the PDO are stored separately in the so-called PDO mapping.

PDOs can only be used if the NMT state machine is in the "Operational" state (see section [Network Management \(NMT\)](#)); the PDOs must be configured in the "Pre-Operational" NMT state.

The controller supports a total of 8 independent PDO mappings; each corresponding PDO message can have a maximum of eight bytes (=64 bit) of user data. It is thereby possible to, for example, transfer two UNSIGNED32 values or one UNSIGNED32 and one UNSIGNED08; the message does not need to use all eight data bytes.

The PDOs differ yet again in the configuration in the send and receive configuration. The receive configuration describes the processing for PDO messages that are sent, and the send configuration describes the PDO messages that are to be sent.

8.2.5.1 RX configuration

To configure an RX-PDO, you must take into account three object categories in the object dictionary:

- The objects that describe the functionality of the mapping.
- The objects that describe the content of the mapping.
- The objects that are to receive the received data.

Configuration of the functionality (communication parameter)

The configuration of the first mapping is stored in the subindices of object 1400_h. The second mapping is configured in 1401_h and so on. In the following, we refer to 140N_h. Here, the configuration affects the COB-ID of the PDO message and the transfer type.

Objects 140N_h have only three subindices:

- Subindex 0 (max. subindex): Total number of subindices
- Subindex 1 (COB-ID): The COB-ID is stored here. For PDO mappings 1–4 (1600_h-1603_h), the CAN-ID is fixed depending on the node-ID and only the valid bit (bit 31) can be set in the COB-ID. From 1604_h–1607_h, the CAN-ID can be set independently (with the restriction that it not be used by other services, see table at the start of chapter [CANopen services](#)) as can the valid bit.

| Mapping | CAN-ID |
|-------------------|----------------------------|
| 1600 _h | 200 _h + Node-ID |
| 1601 _h | 300 _h + Node-ID |
| 1602 _h | 400 _h + Node-ID |
| 1603 _h | 500 _h + Node-ID |
| 1604 _h | xxx _h |
| 1605 _h | xxx _h |
| 1606 _h | xxx _h |
| 1607 _h | xxx _h |

A COB-ID change does not take effect until *after* the controller or communication is restarted (see [Network Management \(NMT\)](#)).

- Subindex 2 (transmission type): A number is stored in this subindex that defines the time at which the received data become valid. The number and the corresponding meaning can be found in the following table.

| 140N _h :02 _h | Meaning |
|------------------------------------|---|
| 00 _h -F0 _h | Synchronous: The data are buffered and not until the next SYNC message is received do they become valid and are they taken over into the object dictionary. |
| F1 _h -FD _h | Reserved |
| FE _h , FF _h | Asynchronous: The data become valid when the PDO message is received and are taken over into the object dictionary. |

Content of a mapping

The configuration of the content of a mapping is structured as follows (see also the following figure as an example):

- All subindices of a configuration object belong together. Thus, 1600_h with all subindices describes the first mapping, 1601_h the second RX-PDO mapping, etc.
- Subindex 00_h specifies how many objects are in a mapping. It simultaneously specifies how many of the subindices are valid. If object 1600_h:00_h is set to "0", RX mapping is thereby completely switched off. In the example shown in the following figure, two objects are thus mapped; object 1600_h:03_h and 1600_h:04_h is, therefore, not active (shown in gray).
- Each subindex from 1600_h:01_h to 1600_h:0F_h describes one target of the mapping sequentially and without gaps. The index, subindex and bit length are thereby encoded. Example from the following figure: The first two bytes of the message are to be written in object 6040_h:00_h. In hexadecimal notation, the content of 1600_h:01_h then consists of <Index><Subindex><Bit length> or 60400010. The second mapping (1600_h:02_h) contains the entry 607A0020. Thus, it maps the following four bytes (=20_hBit) in object 607A_h:00_h

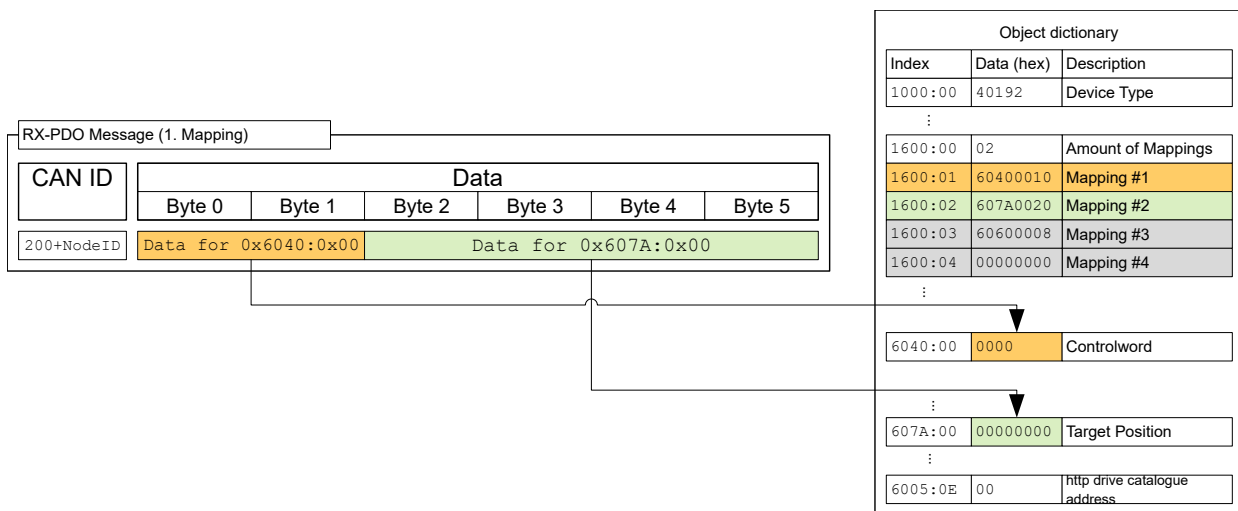

Dummy objects

You can configure RX-PDOs so that more than one node can respond. In this case, it may be desirable for only part of the data contained in the PDO to be evaluated in one of the devices. For data not used locally, you can include a dummy object of one of the supported data types in the mapping of the PDO:

| Index | Data type |
|-------------------|------------|
| 0002 _h | INTEGER8 |
| 0003 _h | INTEGER16 |
| 0004 _h | INTEGER32 |
| 0005 _h | UNSIGNED08 |

| Index | Data type |
|-------------------|------------|
| 0006 _h | UNSIGNED16 |
| 0007 _h | UNSIGNED32 |

8.2.5.2 TX configuration

To configure a TX-PDO, you must take into account three object categories in the object dictionary:

- The objects that describe the functionality of the mapping.
- The objects that describe the content of the mapping.
- The objects that are to receive the data that are to be sent.

Also note that the time at which the data are copied to the TX-PDO message and the time of sending do not need to be the same (dependent on mode).

Configuration of the functionality (communication parameter)

The configuration of the functionality of the first mapping is stored in the subindices of object 1800_h. The second mapping is configured in 1801_h and so on. In the following, we refer to 180N_h. Here, the configuration affects the COB-ID of the PDO message and the transfer type.

Objects 180N_h have the following subindices:

- Subindex 0 (max. subindex): Total number of subindices
- Subindex 1 (COB-ID): The COB-ID is stored here. For PDO mappings 1–4 (1A00_h–1A03_h), the CAN-ID is fixed depending on the node-ID and only the valid bit (bit 31) can be set in the COB-ID. From 1A04_h–1A07_h, the CAN-ID can be set independently (with the restriction that it not be used by other services, see table at the start of chapter [CANopen services](#)) as can the valid bit.

| Mapping | CAN-ID |
|-------------------|----------------------------|
| 1A00 _h | 180 _h + Node-ID |
| 1A01 _h | 280 _h + Node-ID |
| 1A02 _h | 380 _h + Node-ID |
| 1A03 _h | 480 _h + Node-ID |
| 1A04 _h | xxx _h |
| 1A05 _h | xxx _h |
| 1A06 _h | xxx _h |
| 1A07 _h | xxx _h |

A COB-ID change does not take effect until *after* the controller or communication is restarted (see [Network Management \(NMT\)](#)).

- Subindex 2 (transmission type): A number is stored in this subindex that defines the time at which the data are to be copied into the PDO message and when this is to be sent. The number and the corresponding meaning can be found in the following table. Below, we refer to an *Event* that can trigger the copying and/or sending of the data. This *Event* consists of three events, which can be considered independently of one another:
 - The NMT state machine is switched to "operational".
 - The current data have changed with respect to the last PDO message.
 - The *Event Timer* has expired (see 180N_h:5).

If the *Event Timer* is used, it is handled independently of the changes; the *Event Timer* is not restarted until the current event timer expires, not because of another *Event*.

| 180N _h : 02 _h | Meaning |
|-------------------------------------|---|
| 0 | Synchronous (acyclic): The data are copied to the TX-PDO upon arrival of the SYNC but are not sent until the <i>Event</i> . |
| 01 _h -F0 _h | Synchronous (cyclic): The data are copied upon arrival of the nth SYNC message and are sent immediately thereafter (n corresponds to the number 1 to 240, transmission type "1" sends the new data on each SYNC). |
| F1 _h -FB _h | Reserved |
| FC _h | RTR-Only (synchronous): The data are copied upon arrival of each SYNC message but are sent only upon request with an RTR message. |
| FD _h | RTR-Only (event-driven): The data are copied to the TX-PDO message upon receipt of an RTR message and sent immediately thereafter. |
| FE _h , FF _h | The data are copied upon arrival of the <i>Event</i> and sent immediately. |

- Subindex 3 (inhibit time): This subindex contains a time lock in 100 μs steps (see following figure). This can be used to set a time that must elapse after the sending of a PDO before the PDO is sent another time. This time only applies for asynchronous PDOs. This is intended to prevent PDOs from being sent continuously if the mapped object constantly changes.
- Subindex 4 (compatibility entry): This subindex has no function and exists only for compatibility reasons.
- Subindex 5 (event timer): This time (in ms) can be used to trigger an *Event* which handles the copying of the data and the sending of the PDO.
- Subindex 6 (sync start value): Here, the start value of the *Sync Counter* is entered beginning with which the *slave* is to initially respond to the sync and send the PDO. Not globally activated until a value greater than 1 is set in 1019h Synchronous Counter Overflow Value.

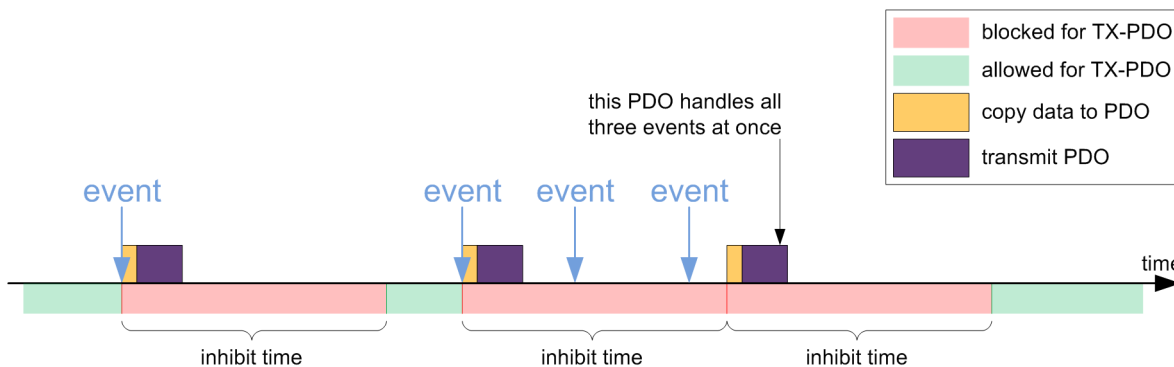

Content of a mapping

The configuration of the content of a mapping is structured as follows (see the following figure as an example):

- All subindices of a configuration object belong together. Thus, 1A00_h with all subindices describes the first mapping, 1A01_h the second TX-PDO mapping, etc.
- Subindex 00 specifies how many objects are in a mapping. It simultaneously specifies how many of the subindices are valid. If object 1A00_h:00_h is set to "0", TX mapping is thereby completely switched off. In the following example, two objects are thereby mapped in entries 1A00_h:01_h – 1A00_h:02_h. The objects in entries 1A00_h:03_h – 1A00_h:04_h are, thus, not mapped (shown in gray).
- Each subindex from 1A00_h:01_h to 1A00_h:0F_h respectively describes sequentially and without gaps (dummy objects can be used for gaps) one source of the mapping. The index, subindex and bit length are thereby encoded. Example from the following figure: The first two bytes of the message are to be read from object 6041_h:00_h. In hexadecimal notation, the content of 1A00_h:01_h then consists of <Index><Subindex><Bit Length>, or 60410010. The second mapping (1A00_h:02_h) contains the entry 60640020. Thus, it maps the following four bytes (corresponds to 32 bits) from object 6064_h:00_h in the TX-PDO message.

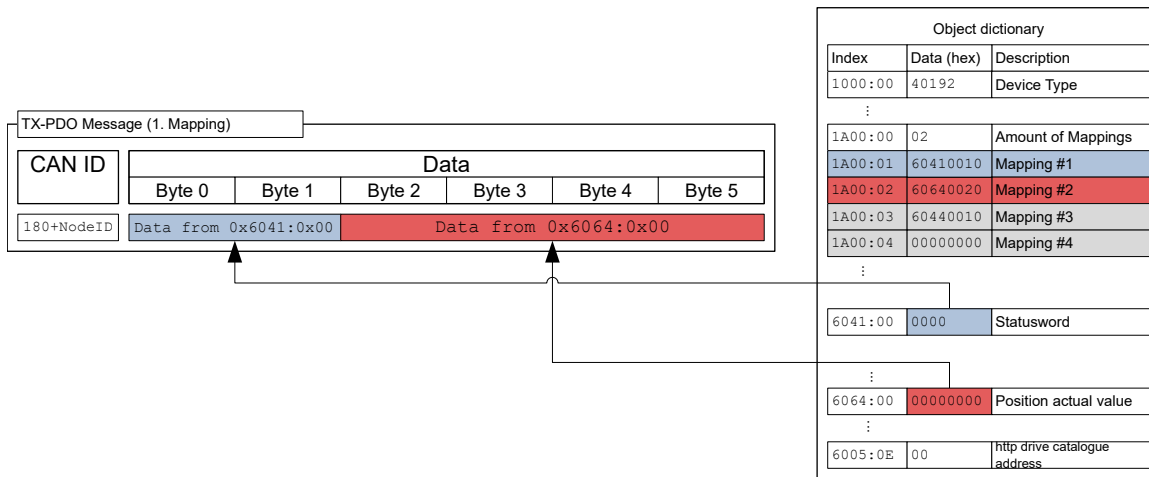

8.2.5.3 Presetting

The following configuration is preset:

RX-PDO

- Mapping (CAN-ID: 200_h + Node-ID):
 - 6040_h:00_h (controlword)
 - 6060_h:00_h (mode of operation)
- Mapping (CAN-ID: 300_h + Node-ID):
 - 607A_h:00_h (target position)
 - 6081_h:00_h (profile velocity)
- Mapping (CAN-ID: 400_h + Node-ID): object 6042_h:00_h (vl target velocity)
- Mapping (CAN-ID: 500_h + Node-ID): object 60FE_h:01_h (digital outputs)

TX-PDO

- Mapping (CAN-ID: 180_h + Node-ID):
 - 6041_h:00_h (statusword)
 - 6061_h:00_h (Modes Of Operation Display)
- Mapping (CAN-ID: 280_h + Node-ID): 6064_h:00_h (Position actual value)
- Mapping (CAN-ID: 380_h + Node-ID): 6044_h:00_h (vl velocity actual value)
- Mapping (CAN-ID: 480_h + Node-ID): object 60FD_h:00_h (digital inputs)

8.2.5.4 Changing PDO mapping

You change the PDO mapping in the "Pre-operational" NMT state as follows:

- Deactivate the PDO by setting the *Valid Bit* (bit 31) of subindex 01h of the corresponding communication parameter (e.g., 1400_h:01_h) to "1".
- Deactivate the mapping by setting subindex 00h of the corresponding mapping parameter (e.g., 1600_h:00_h) to "0".
- Change the mapping in the desired subindices (e.g., 1600_h:01_h).
- Activate the mapping by writing the number of objects that are to be mapped in subindex 00h of the corresponding mapping parameter (e.g., 1600_h:00_h).
- Activate the PDO by setting bit 31 of subindex 01h of the corresponding communication parameter (e.g., 1400_h:01_h) to "0".
- Store the configuration by writing the value "65766173h" in 1010_h:02_h.

8.2.6 Boot-Up Protocol

If the CAN slave reaches the "Pre-Operational" NMT state (see following figure), the following message is sent to signal operational readiness.

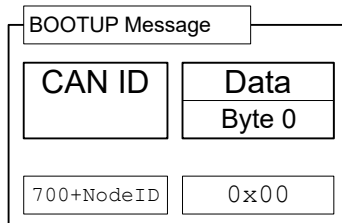

This service is unconfirmed; there is no response.



NOTICE

The boot loader sends its own boot-up message. This can be suppressed, see object `2007h:00`

8.2.7 Heartbeat and Nodeguarding

With the "Heartbeat" and "Nodeguarding" services (often also referred to as "Liveguarding"), switched-off or hung devices on the CAN bus can be found. For this purpose, the NMT master cyclically requests a message with the current NMT state of the slave (Nodeguarding).

The alternative is that each slave sends a message unprompted and cyclically (Heartbeat). A combination of Nodeguarding and Heartbeat is not permissible. Furthermore, it is recommended that Heartbeat be given preference over Nodeguarding, as Nodeguarding results in a higher load on the CAN bus.

8.2.7.1 Nodeguarding

This service is based on the fact that the NMT master sends an RTR message with CAN-ID $700_{\text{h}} + \text{node-ID}$ to the respective slave.

The slave must then send a message as response; this message is structured as follows. Bit 7 alternates here on each transfer, thereby allowing one to determine if a message was lost. Entered in bits 6 to 0 is the current NMT status of the slave.

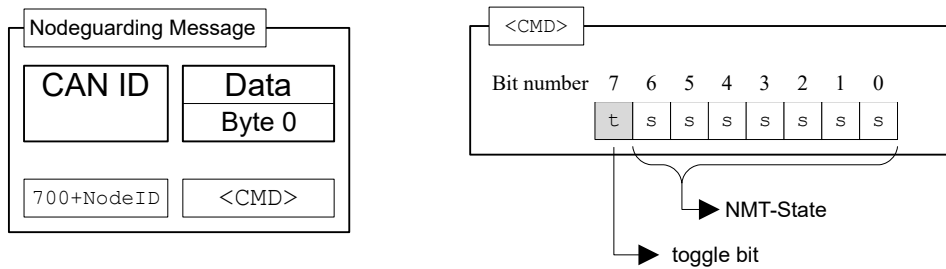

With Nodeguarding, there exist three time intervals (see also the following figure):

- *guard time*: The time between two RTR messages. This can be different for each CAN node and is stored in the slave in object `100Ch:00` (unit: milliseconds)
- *live time factor*: A multiplier for the *guard time*; this is stored in the CAN slave in object `100Dh:00` and can be different for each slave on the CAN bus.
- *possible live time*: The time produced by multiplying *guard time* and *live time factor*.

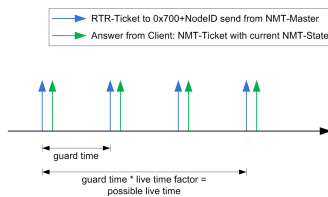

The following conditions are checked during Nodeguarding:

- The NMT master must send the RTR request within the "possible live time".
- The slave must send the response to the RTR request within the "possible live time".
- The slave must respond with its NMT state. In addition, the "toggle bit" must be set correctly.

8.2.7.2 Heartbeat

If Heartbeat is activated, the slave sends its NMT state to the CAN bus unprompted and cyclically. You activate this service by setting the *Producer Heartbeat Time* time in object `1017h:00h` to a value other than zero. The *Producer Heartbeat Time* is measured in milliseconds. The message sent by the slave has the form shown below:

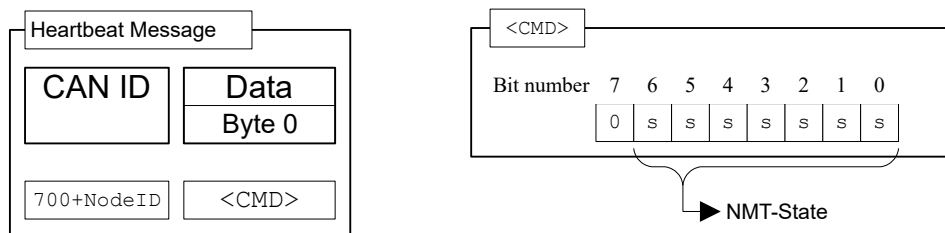

The slave must send the Heartbeat message within the *Heartbeat Consumer Time*. This time is known only to the master and is not stored in the controller.

The slave can also monitor a *Heartbeat* from another *producer* (master or another slave). To do this, enter the *Consumer Heartbeat Time* and the node-ID of the *producer* in object 1016_h.

Errors that occur during this monitoring are reset if either the function is deactivated or the *Heartbeat* is again sent within the correct time.

8.3 LSS protocol

The services of the *LSS protocol (Layer Settings Services)* are used to assign the node-ID and/or the baud rate of the controller directly via the CANopen bus. This is especially useful with devices that have no means for the mechanical configuration (e.g., rotary switches) of the parameters.

8.3.1 General

The *LSS protocol* requires a CANopen device in the network that performs the role of the *LSS master*. All other devices have the role of the *LSS slave*.

Each *LSS slave* is equipped with a unique *LSS address* that consists of the four 32-bit entries of object 1018_h Identity Object.

An *LSS slave* may either be in *configuration mode* or in *wait mode*. The *LSS master* is responsible for switching between the two modes. Some *LSS services (Configuration, Inquiry)* are only available in *configuration mode*.

8.3.2 LSS message

All messages of the *LSS protocol* consist of 8 bytes (*DLC=8*), whereby byte 0 always contains the *Command Specifier (CS)* of the service.

Two CAN IDs are reserved for the *LSS protocol*:

- 7E5_h: For the messages from the *LSS master* to the *LSS slaves* (request)
- 7E4_h: For the messages from the *LSS slaves* to the *LSS master* (response)

8.3.3 LSS services

Four service categories are supported:

- Switch state services
- Configuration services

- [Inquiry services](#)
- [Identification services](#)

8.3.3.1 Switch state services

With these services, the *LSS master* can switch the *LSS slaves* to *configuration mode* or to *wait mode*.

The node-ID and baud rate can only be changed with the [Configuration services](#) and [Inquiry services](#) while in *configuration mode*.

Switch state global service

With this service, the *LSS master* switches all *LSS slaves* in the network to *configuration mode* or to *wait mode*.

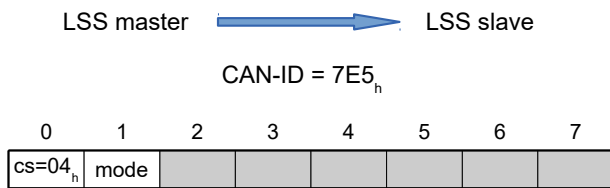

Byte 0 : CS (Command Specifier)

Value = "04_h"

Byte 1: mode

Value = "00_h": Switches to *wait mode*

Value = "01_h": Switches to *configuration mode*

Bytes 2-7 :

reserved (=0_h)

Switch state selective service

With this service, the *LSS master* switches the *LSS slaves* with the (or parts of the) corresponding *LSS address* to *configuration mode*.

The *LSS master* sends four messages, which contain the *LSS address*:

1. The *LSS master* switches the *LSS slaves* with the corresponding *vendor ID* to *configuration mode*:

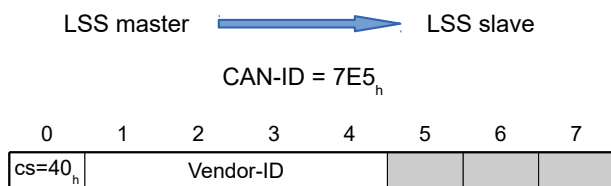

Byte 0 : CS (Command Specifier)

Value = "40_h"

Bytes 1-4: Vendor-ID

Vendor-ID: see 1018_h:01_h

Bytes 5-7:

reserved (=0_h)

2. The *LSS master* switches the *LSS slaves* with the corresponding *product code* to *configuration mode*:

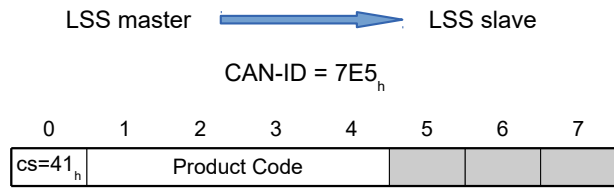
**Byte 0 : CS (Command Specifier)**Value = "41_h"**Bytes 1-4: Product Code**Product code: see 1018_h:02_h**Bytes 5-7:**reserved (=0_h)

3. The LSS master switches the LSS slaves with the corresponding revision number to configuration mode:

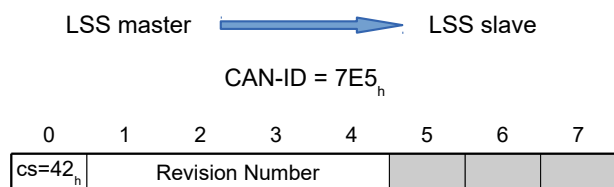
**Byte 0 : CS (Command Specifier)**Value = "42_h"**Bytes 1-4: Revision Number**Revision number: see 1018_h:03_h**Bytes 5-7:**reserved (=0_h)

4. The LSS master switches the LSS slaves with the corresponding serial number to configuration mode:

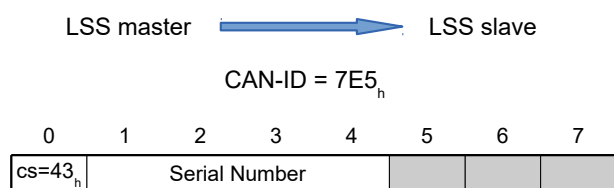
**Byte 0 : CS (Command Specifier)**Value = "43_h"**Bytes 1-4: mode**Serial number: see 1018_h:04_h**Bytes 5-7:**reserved (=0_h)

The LSS slave with the corresponding LSS address was switched to configuration mode and sends a confirmation:

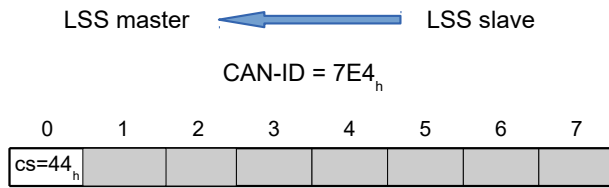
**Byte 0 : CS (Command Specifier)**Value = "44_h"**Bytes 1-7 :**reserved (=0_h)**8.3.3.2 Configuration services**

With these services, the *LSS master* can change and, if necessary, store the node-ID or baud rate of the *LSS slaves*.

**NOTICE**

The *LSS slaves* must be in *configuration mode*. See chapter [Switch state services](#).

Configure node-ID service

The *LSS master* sends a message with the new node-ID to an *LSS slave*:

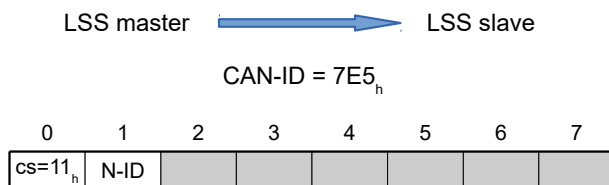
**Byte 0 : CS (Command Specifier)**Value = "11_h"**Byte 1: N-ID (Node-ID)**Valid node-ID between 01_h and 7F_h**Bytes 2-7 :**reserved (=0_h)

The *LSS slave* responds with a confirmation/error code:

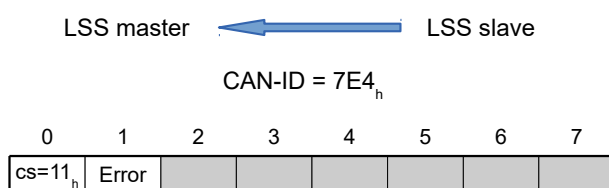

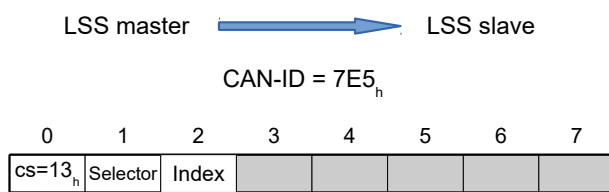
Byte 0 : CS (Command Specifier)Value = "11_h"**Byte 1: Error Code**Value = "00_h": Not an errorValue = "01_h": Invalid node-ID**Bytes 2-7 :**reserved (=0_h)**Configure bit timing parameters service**The *LSS master* sends a message with the new baud rate to an *LSS slave*:**Byte 0 : CS (Command Specifier)**Value = "13_h"**Byte 1: Table Selector**Value = "00_h": The table for the baud rate from the *CiA 301* standard is used.**Byte 2: Table Index**

The value for the index is taken from the following table.

Bytes 3-7 :reserved (=0_h)The following values are supported for the *Table Index*:

| Table Index | Baud rate in kBd |
|-------------|------------------|
| 0 | 1000 |
| 2 | 500 |
| 3 | 250 |
| 4 | 125 |
| 6 | 50 |
| 7 | 20 |
| 8 | 10 |

The *LSS slave* responds with a confirmation/error code:

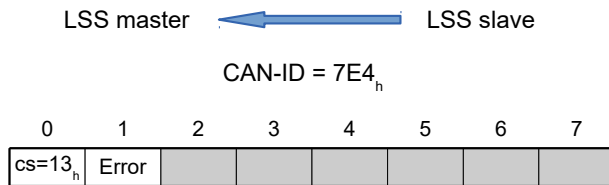
**Byte 0 : CS (Command Specifier)**Value = "13_h"**Byte 1: Error Code**Value = "00_h": Not an errorValue = "01_h": Invalid *Table Index*/baud rate is not supported**Bytes 2-7 :**reserved (=0_h)**Activate bit timing parameters service**

The *LSS master* uses this command to activate the set baud rate of all *LSS slaves* in the network simultaneously:

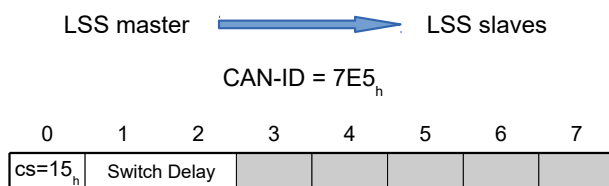
**Byte 0 : CS (Command Specifier)**Value = "15_h"**Bytes 1-2: Switch Delay**

Delay in ms. It is thereby ensured that all *LSS slaves* in the network have the same baud rate before messages may again be sent.

After receiving this messages from each *LSS slave*, the time that is stored here is allowed to elapse. Only then is the new baud rate accepted.

The same time is allowed to elapse a second time; only then may an *LSS slave* send messages again.

Bytes 3-7 :reserved (=0_h)**Store configuration service**

With this command, the *LSS master* saves the set node-ID and baud rate of an *LSS slave*. The *LSS master* must ensure that at that moment only one *LSS slave* in the network is in *configuration mode*.

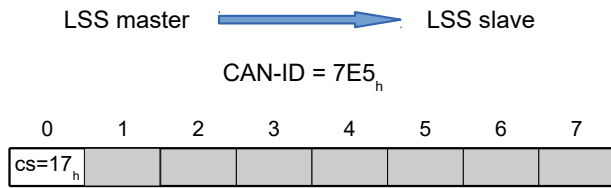
**Byte 0 : CS (Command Specifier)**Value = "17_h"**Bytes 1-7 :**reserved (=0_h)

The LSS slave responds with a confirmation/error code:

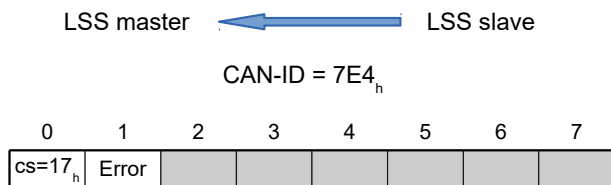
**Byte 0 : CS (Command Specifier)**Value = "17_h"**Byte 1: Error Code**Value = "00_h": Not an errorValue = "02_h": Access of non-volatile memory failed**Bytes 2-7 :**reserved (=0_h)**8.3.3.3 Inquiry services**

With these services, the LSS master can query the LSS address or the node-ID of an LSS slave. The LSS master must ensure that only one LSS slave in the network is in *configuration mode*.

Inquire LSS address service

With this service, the LSS master queries the LSS address of a slave.

1. The LSS master queries the *vendor ID*:

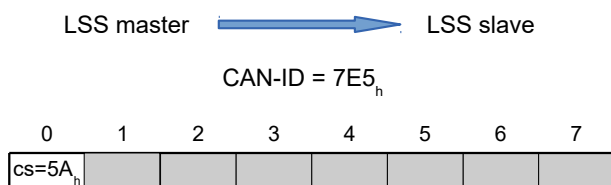
**Byte 0 : CS (Command Specifier)**Value = "5A_h"**Bytes 1-7 :**reserved (=0_h)

The LSS slave returns its *vendor ID*:

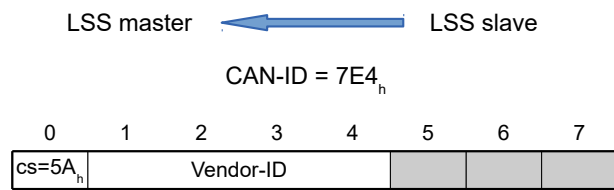

Byte 0 : CS (Command Specifier)

Value = "5A_h"

Bytes 1-4: Vendor-ID

Vendor-ID: see 1018_h:01_h

Bytes 5-7:

reserved (=0_h)

2. The LSS master queries the *product code*:

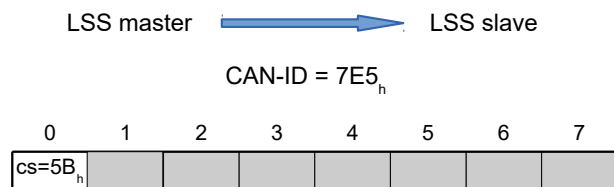

Byte 0 : CS (Command Specifier)

Value = "5B_h"

Bytes 1-7 :

reserved (=0_h)

The LSS slave returns its *product code*:

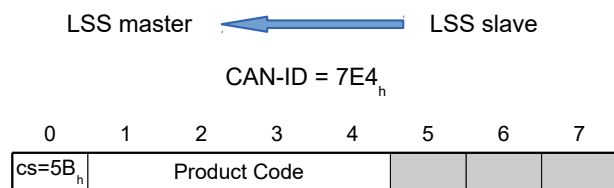

Byte 0 : CS (Command Specifier)

Value = "5B_h"

Bytes 1-4: Product Code

Product code: see 1018_h:02_h

Bytes 5-7:

reserved (=0_h)

3. The LSS master queries the *revision number*.

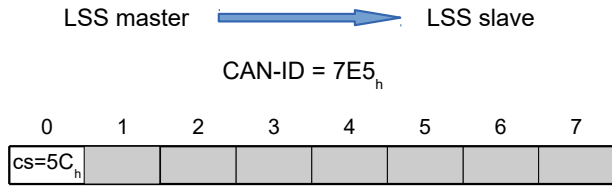

Byte 0 : CS (Command Specifier)

Value = "5C_h"

The LSS slave returns its revision number.

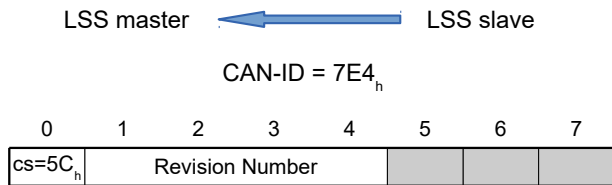

Byte 0 : CS (Command Specifier)

Value = "5C_h"

Bytes 1-4: Revision Number

Revision number: see 1018_h;03_h

Bytes 5-7:

reserved (=0_h)

4. The LSS master queries the serial number.

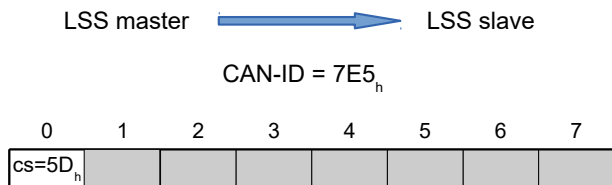

Byte 0 : CS (Command Specifier)

Value = "5D_h"

Bytes 1-7 :

reserved (=0_h)

The LSS slave returns its serial number.

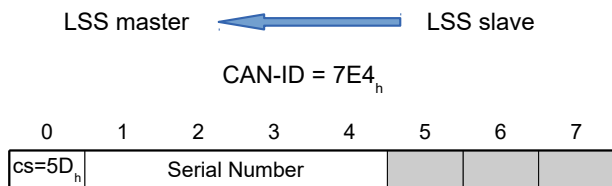

Byte 0 : CS (Command Specifier)

Value = "5D_h"

Bytes 1-4: Serial Number

Serial number: see 1018_h:04_h

Bytes 5-7:

reserved (=0_h)

Inquire node-ID service

With this service, the *LSS master* queries the node-ID of a slave.

The *LSS master* queries the node-ID:

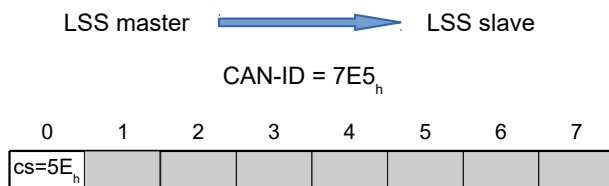
**Byte 0 : CS (Command Specifier)**

Value = "5E_h"

Bytes 1-7 :

reserved (=0_h)

The *LSS slave* responds with its node-ID:

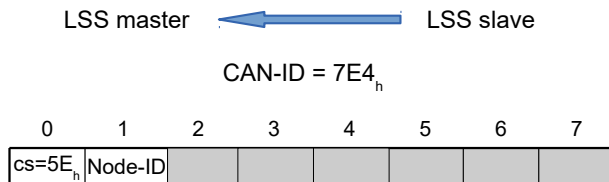
**Byte 0 : CS (Command Specifier)**

Value = "5E_h"

Byte 1: Node-ID

Node-ID of the *LSS slave*

Bytes 2-7 :

reserved (=0_h)

8.3.3.4 Identification services

With these services, the *LSS master* can ask the *LSS slaves* to identify themselves based on their *LSS address*.

LSS identify remote slave service

With this service, the *LSS master* asks the *LSS slaves* to identify themselves with the (or parts of the) corresponding *LSS address* with the LSS identify slave service.

A range can be defined for the *revision number* and the *serial number*. All *LSS slaves* whose numbers are in the corresponding range must identify themselves. It is the task of the *LSS master* to restrict the range so that ultimately only one *LSS slave* responds.

1. The *LSS master* defines the *Vendor-ID* of the *LSS slaves* that are to identify themselves:

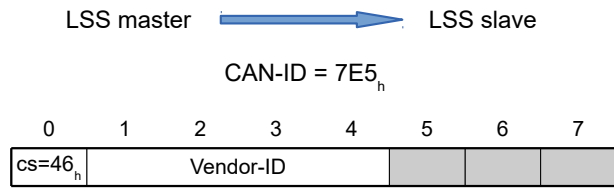
**Byte 0 : CS (Command Specifier)**Value = "46_h"**Bytes 1-4: Vendor-ID**Vendor-ID: see 1018_h:01_h**Bytes 5-7:**reserved (=0_h)

2. The LSS master defines the *product code* of the LSS slaves that are to identify themselves.:

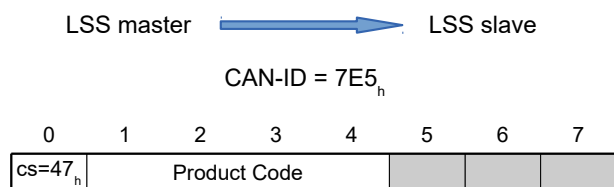
**Byte 0 : CS (Command Specifier)**Value = "47_h"**Bytes 1-4: Product Code**Product code: see 1018_h:02_h**Bytes 5-7:**reserved (=0_h)

3. The LSS master defines the lowest and highest *revision number* of a range. All LSS slaves whose *revision number* is within this range are to identify themselves:

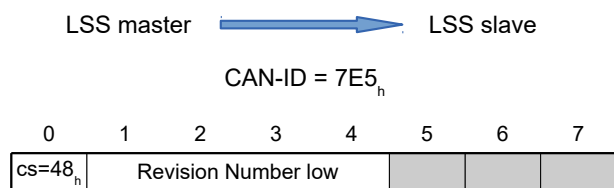
**Byte 0 : CS (Command Specifier)**Value = "48_h"**Bytes 1-4: Revision Number low**Lowest *revision number* of the range: see 1018_h:03_h**Bytes 5-7:**reserved (=0_h)

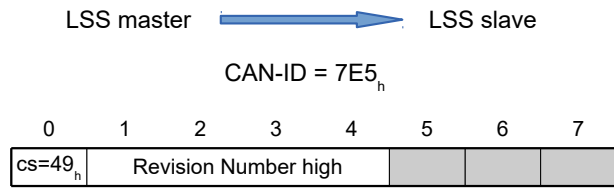
**Byte 0 : CS (Command Specifier)**Value = "49_h"**Bytes 1-4: Revision Number high**Highest *revision number* of the range: see 1018_h:03_h**Bytes 5-7:**reserved (=0_h)

4. The LSS master defines the lowest and highest *serial number* of a range. All LSS slaves whose *serial number* is within this range are to identify themselves:

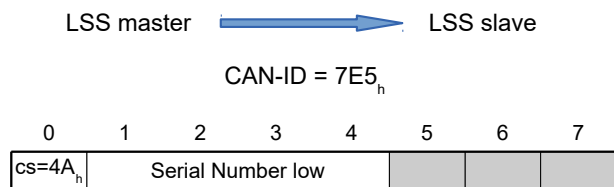
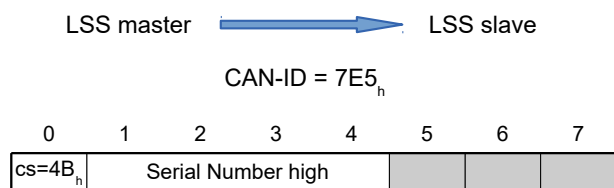
**Byte 0 : CS (Command Specifier)**Value = "4A_h"**Bytes 1-4: Serial Number low**Lowest *serial number* of the range: see 1018_h:04_h**Bytes 5-7:**reserved (=0_h)**Byte 0 : CS (Command Specifier)**Value = "4B_h"**Bytes 1-4: Serial Number high**Highest *serial number* of the range: see 1018_h:04_h**Bytes 5-7:**reserved (=0_h)**LSS identify slave service**

The LSS slave whose LSS address was defined with the LSS identify remote slave service by the LSS master identifies itself:

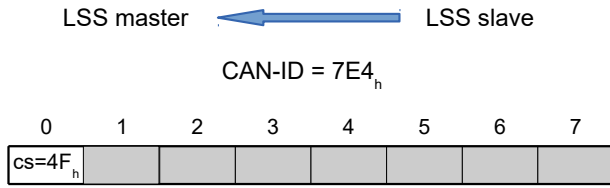
**Byte 0 : CS (Command Specifier)**Value = "4F_h"**Bytes 1-7 :**reserved (=0_h)**8.3.4 Example**

The controller (*LSS slave*) is delivered with the following parameters:

- Node-ID = 7F_h (=127_d)
- Baud rate = 1000 kBd

The parameters are to be set as follows:

- Node-ID = 05_h (=5_d)
- Baud rate = 125 kBd

It is assumed that only one *LSS slave* is currently present in the network.

1. The *LSS master* switches the *LSS slave* to *configuration mode* (see [Switch state global service](#)):
7E5 | 04 01 00 00 00 00 00 00
2. The *LSS master* queries the node-ID of the *LSS slave* (see [Inquire node-ID service](#)):
7E5 | 5E 00 00 00 00 00 00 00
The *LSS slave* responds with its node-ID:
7E4 | 5E 7F 00 00 00 00 00 00
3. The *LSS master* sets the node-ID to "05_h" (see [Configure node-ID service](#)):
7E5 | 11 05 00 00 00 00 00 00
The *LSS slave* confirms (error code=00_h):
7E4 | 11 00 00 00 00 00 00 00
4. The *LSS master* sets the baud rate to 125 kBd (*Table Index*=4) (see [Configure bit timing parameters service](#)):
7E5 | 13 00 04 00 00 00 00 00
The *LSS slave* confirms (error code=00_h):
7E4 | 13 00 00 00 00 00 00 00
5. The *LSS master* sends the command to save the changes (see [Store configuration service](#)):
7E5 | 17 00 00 00 00 00 00 00
6. The *LSS master* switches the *LSS slave* to *wait mode* (see [Switch state global service](#)):
7E5 | 04 00 00 00 00 00 00 00
The *LSS slave* confirms (error code=00_h):
7E4 | 17 00 00 00 00 00 00 00
7. The new parameters are accepted after the controller is restarted.

The controller registers with node-ID 5 and baud rate 125 kBd:

```
705 | 00
```

9 Programming with NanoJ

NanoJ is a programming language similar to *C* or *C++*. *NanoJ* is integrated in the *Plug & Drive Studio* software. You can find further information in the document *Plug & Drive Studio: Quick Start Guide* at us.nanotec.com.

9.1 NanoJ program

A *NanoJ* program makes a protected runtime environment available within the firmware. Here, the user can create his own processes. These can then trigger functions in the controller by, for example, reading or writing entries in the object dictionary.

Through the use of protective mechanisms, a *NanoJ* program is prevented from crashing the firmware. In the worst case, the execution is interrupted with an error code stored in the object dictionary.

If the *NanoJ* program was loaded on the controller, it is automatically executed after the controller is switched on or restarted, as long as you do not set bit 0 in object `2300h` to "0".

9.1.1 Available computing time

A *NanoJ* program receives computing time cyclically in a 1 ms clock (see following figure). Because computing time is lost through interrupts and system functions of the firmware, only a portion of the computing time is available to the user program (depending on control mode and application). In this time, the user program must run through the cycle and either complete the cycle or yield the computing time by calling the `yield()` function. In the former case, the user program is restarted with the start of the next 1 ms cycle; the latter results in the program being continued on the next 1 ms cycle with the command that follows the `yield()` function.

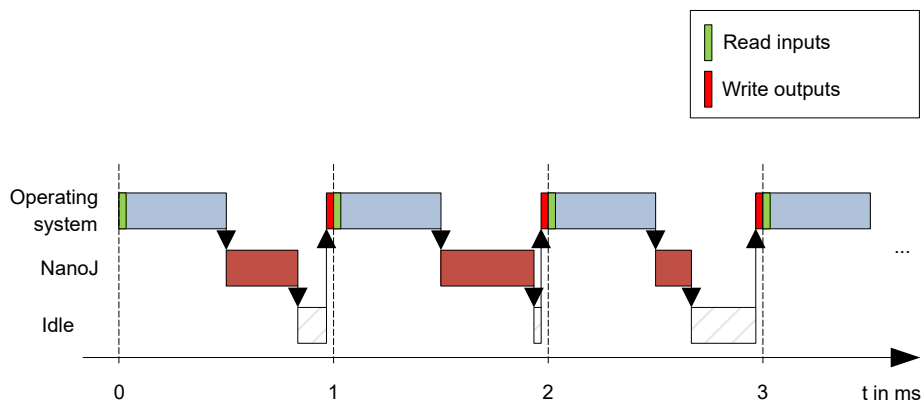

If the *NanoJ* program needs more time than was allotted, it is ended and an error code set in the object dictionary.

TIP



When developing user programs, the runtime behavior must be carefully examined, especially for more time-intensive tasks. For example, it is therefore recommended that tables be used instead of calculating a sine value using a `sin` function.

NOTICE



If the *NanoJ program* does not yield the computing time after too long a time, it is ended by the operating system. In this case, the number 4 is entered in the statusword for object 2301_h; in the error register for object 2302_h, the number 5 (timeout) is noted, see [2301h NanoJ Status](#) and [2302h NanoJ Error Code](#).

To keep the *NanoJ program* from stopping, you can activate *AutoYield* mode by writing value "5" in 2300_h. In *AutoYield* mode, however, the *NanoJ program* is no longer real-time capable and no longer runs every 1 ms.

9.1.2 Protected runtime environment

Using process-specific properties, a so-called *protected runtime environment* is generated. A user program in the protected runtime environment is only able to access specially allocated memory areas and system resources. For example, an attempt to directly write to a processor IO register is acknowledged with an *MPU Fault* and the user program terminated with the corresponding error code in the object dictionary.

9.1.3 NanoJ program – communication possibilities

A *NanoJ program* has a number of possibilities for communicating with the controller:

- Read and write OD values using PDO mapping
- Directly read and write OD values via NanoJ functions
- Call other NanoJ functions (e.g., write [debug output](#))

The OD values of the user program are made available in the form of variables via *PDO mapping*. Before a user program receives the 1 ms time slot, the firmware transfers the values from the object dictionary to the variables of the user program. As soon as the user program receives computing time, it can manipulate these variables as regular C variables. At the end of the time slot, the new values are then automatically copied by the firmware back to the respective OD entries.

To optimize the performance, three types of mapping are defined: input, output, and input/output (In, Out, InOut).

- *Input mappings* can only be read; they are not transferred back to the object dictionary.
- *Output mappings* can only be written.
- *Input/output mappings*, on the other hand, can both be read and written.

The set mappings can be read and checked via the GUI for objects 2310_h, 2320_h, and 2330_h. Up to 16 entries are allowed for each mapping.

Whether a variable is stored in the input, output or data range is controlled in *Plug & Drive Studio* via the specification of the *linker section*.

NanoJ inputs and NanoJ outputs

To communicate with the *NanoJ program* via the respective interface, you can use the following objects:

- [2400h NanoJ Inputs](#): Array with thirty-two S32 values for passing values to the *NanoJ program*
- [2410h NanoJ Init Parameters](#): Array with thirty-two S32 values. This object can be stored, unlike 2400_h.
- [2500h NanoJ Outputs](#): Array with thirty-two S32 values, where the *NanoJ program* can store values that can be read out via the fieldbus

9.1.4 Executing a NanoJ program

When executing a cycle, the *NanoJ program* essentially consists of the following three steps with respect to the PDO mapping:

1. Read values from the object dictionary and copy them to the input and output areas
2. Execute a user program
3. Copy values from the output and input areas back to the object dictionary

The configuration of the copy processes is based on the CANopen standard.

In addition, values of the object dictionary can be accessed via NanoJ functions. This is generally slower; mappings are therefore to be preferred. The number of mappings is limited (16 entries each in In/Out/InOut).

TIP



Nanotec recommends: Map OD entries that are used and changed frequently and use NanoJ function to access OD entries that are used less frequently.

A list of available NanoJ functions can be found in chapter [NanoJ functions in the NanoJ program](#).

TIP



Nanotec recommends accessing a given OD value either by mapping or using a NanoJ function with `od_write()`. If both are used simultaneously, the NanoJ function has no effect.

9.1.5 NanoJ program – OD entries

The *NanoJ program* is controlled and configured in object range 2300_h to 2330_h (see [2300h NanoJ Control](#)).

| OD-Index | Name and description |
|-------------------|--|
| 2300 _h | 2300h NanoJ Control |
| 2301 _h | 2301h NanoJ Status |
| 2302 _h | 2302h NanoJ Error Code |
| 2310 _h | 2310h NanoJ Input Data Selection |
| 2320 _h | 2320h NanoJ Output Data Selection |
| 2330 _h | 2330h NanoJ In/output Data Selection |

Example:

To start the *TEST1.USR* user program, the following sequence can, for example, be used:

- Check entry 2302_h for error code.
- If no error:
Start the *NanoJ program* by writing object 2300_h, bit 0 = "1" or by restarting the controller.

NOTICE



It can take up to 200 ms for the NanoJ program to start.

- Check entry 2302_h for error code and object 2301_h, bit 0 = "1".

To stop a running program: write entry 2300_h with bit 0 value = "0".

9.1.6 Structure of a NanoJ program

A user program consists of at least two instructions:

- the preprocessor instruction `#include "wrapper.h"`
- the `void user() {}` function

The code to be executed can be stored in the `void user()` function.

NOTICE



The file names of the user programs must not be longer than eight characters plus three characters in the suffix; file name `main.cpp` is permissible, file name `aLongFileName.cpp` is not permissible.

NOTICE



In *NanoJ programs*, global variables may only be initialized within functions. It then follows:

- No `new` operator
- No constructors
- No initialization of global variables outside of functions

Examples:

The global variable is to be initialized within the `void user()` function:

```
unsigned int i;
void user(){
  i = 1;
  i += 1;
}
```

The following assignment results in an error during compilation:

```
unsigned int i = 1;
void user() {
  i += 1;
}
```

9.1.7 NanoJ program example

The example shows the programming of a square wave signal in object `2500h:01h`.

```
// file main.cpp
map S32 outputReg1 as inout 0x2500:1
#include "wrapper.h"

// user program
void user()
{
  U16 counter = 0;
  while( 1 )
  {
    ++counter;

    if( counter < 100 )
      InOut.outputReg1 = 0;
    else if( counter < 200 )
      InOut.outputReg1 = 1;
    else
      counter = 0;

    // yield() 5 times (delay 5ms)
    for(U08 i = 0; i < 5; ++i )
      yield();
  }
} // eof
```

You can find other examples at us.nanotec.com.

9.2 Mapping in the NanoJ program

With this method, a variable in the *NanoJ program* is linked directly with an entry in the object dictionary. The creation of the mapping must be located at the start of the file here, even before the `#include "wrapper.h"` instruction.

TIP

Nanotec recommends:



- Use mapping if you need to access an object in the object dictionary frequently, e. g., *controlword* 6040_h or *statusword* 6041_h.
- The `od_write()` and `od_read()` functions are better suited for accessing objects a single time, see [Accessing the object dictionary](#).

9.2.1 Declaration of the mapping

The declaration of the mapping is structured as follows:

```
map <TYPE> <NAME> as <input|output|inout> <INDEX>:<SUBINDEX>
```

Where:

- `<TYPE>`
The data type of the variable; U32, U16, U08, S32, S16 or S08.
- `<NAME>`
The name of the variable as it is used in the user program.
- `<input|output|inout>`
The read and write permission of a variable: a variable can be declared as an *input*, *output* or *inout*. This defines whether a variable is readable (*input*), writable (*output*) or both (*inout*) and the structure by means of which it must be addressed in the program.
- `<INDEX>:<SUBINDEX>`
Index and subindex of the object to be mapped in the object dictionary.

Each declared variable is addressed in the user program via one of the three structures: *In*, *Out* or *InOut* depending on the defined write and read direction.

NOTICE



A comment is only permitted above the respective mapping declaration in the code, not on the same line.

9.2.2 Example of mapping

Example of a mapping and the corresponding variable accesses:

```
// 6040h:00h is UNSIGNED16
map U16 controlWord as output 0x6040:00
// 6041h:00h is UNSIGNED16
map U16 statusWord as input 0x6041:00

// 6060h:00h is SIGNED08 (INTEGER8)
map S08 modeOfOperation as inout 0x6060:00
```

```
#include "wrapper.h"

void user()
{
  [...]
  Out.controlWord = 1;
  U16 tmpVar = In.statusword;
  InOut.modeOfOperation = tmpVar;
  [...]
}
```

9.2.3 Possible error at `od_write()`

A possible source of errors is a write access with the `od_write()` function (see [NanoJ functions in the NanoJ program](#)) of an object in the object dictionary that was simultaneously created as mapping. The code listed in the following is incorrect:

```
map U16 controlWord as output 0x6040:00
#include " wrapper.h"
void user()
{
  [...]
  Out.controlWord = 1;
  [...]
  od_write(0x6040, 0x00, 5 ); // der Wert wird durch das Mapping überschrieben
  [...]
}
```

The line with the `od_write(0x6040, 0x00, 5);` command has no effect. As described in the introduction, all mappings are copied to the object dictionary at the end of each millisecond.

This results in the following sequence:

1. The `od_write` function writes the value 5 in object 6040_h:00_h.
2. At the end of the 1 ms cycle, the mapping is written that also specifies object 6040_h:00_h, however, with the value 1.
3. From the perspective of the user, the `od_write` command thus serves no purpose.

9.3 NanoJ functions in the NanoJ program

With NanoJ functions, it is possible to call up functions integrated in the firmware directly from a user program. Code can only be directly executed in the protected area of the protected execution environment and is realized via so-called *Cortex Supervisor Calls* (Svc Calls). Here, an interrupt is triggered when the function is called, thereby giving the firmware the possibility to temporarily permit code execution outside of the protected execution environment. Developers of user programs do not need to worry about this mechanism – for them, the NanoJ functions can be called up like normal C functions. Only the `wrapper.h` file needs to be integrated as usual.

9.3.1 Accessing the object dictionary

`void od_write (U32 index, U32 subindex, U32 value)`

This function writes the transferred value to the specified location in the object dictionary.

| | |
|----------|---|
| index | Index of the object to be written in the object dictionary |
| subindex | Subindex of the object to be written in the object dictionary |
| value | Value to be written |

NOTICE



It is highly recommended that the processor time be passed on with `yield()` after calling a `od_write()`. The value is immediately written to the OD. For the firmware to be able to trigger actions that are dependent on this, however, it must receive computing time. This, in turn, means that the user program must either be ended or interrupted with `yield()`.

U32 **od_read** (U32 index, U32 subindex)

This function reads the value at the specified location in the object dictionary and returns it.

| | |
|--------------|--|
| index | Index of the object to be read in the object dictionary |
| subindex | Subindex of the object to be read in the object dictionary |
| Output value | Content of the OD entry |

NOTICE



Active waiting for a value in the object dictionary should always be associated with a `yield()`.

Example

```
while (od_read(2400,2) != 0) // wait until 2400:2 is set
{ yield(); }
```

9.3.2 Process control

```
void yield()
```

This function returns the processor time to the operating system. In the next time slot, the program continues at the location after the call.

```
void sleep (U32 ms)
```

This function returns the processor time to the operating system for the specified number of milliseconds. The user program is then continued at the location after the call.

| | |
|----|-----------------------------------|
| ms | Time to be waited in milliseconds |
|----|-----------------------------------|

9.3.3 Debug output

The following functions output a value in the debug console. They differ with respect to the data type of the parameter to be passed.

```
bool VmmDebugOutputString (const char *outstring)
```

```
bool VmmDebugOutputInt (const U32 val)
```

```
bool VmmDebugOutputByte (const U08 val)
```

```
bool VmmDebugOutputHalfWord (const U16 val)
```

```
bool VmmDebugOutputWord (const U32 val)
```

```
bool VmmDebugOutputFloat (const float val)
```

NOTICE



The debug outputs are first written to a separate area of the object dictionary and read from there by the *Plug & Drive Studio*.

This OD entry has index 2600_h and is 64 characters long, see [2600h NanoJ Debug Output](#). Subindex 00 always contains the number of characters already written.

If the buffer is full, `VmmDebugOutputxxx()` initially fails; execution of the user program ceases and it stops at the location of the debug output. Only after the GUI has read the buffer and after subindex 00 has been reset does the program continue and `VmmDebugOutputxxx()` returns to the user program.

NOTICE



Debug outputs may therefore only be used during the test phase when developing a user program.

NOTICE



Do not use the debug output if *AutoYield* mode is activated (see [Available computing time](#)).

9.4 Restrictions and possible problems

Restrictions and possible problems when working with NanoJ are listed below:

| Restriction/problem | Measure |
|---|--|
| If an object is mapped, e. g., 0x6040, the object is reset to its previous value every 1 ms. This makes it impossible to control this object via the fieldbus or the <i>Plug & Drive Studio</i> . | Instead use <code>od_read/od_write</code> to access the object. |
| If an object was mapped as output and the value of the object was never defined before starting the <i>NanoJ program</i> , the value of this object may be random. | Initialize the values of the mapped objects in your NanoJ program to ensure that it behaves deterministically. |

| Restriction/problem | Measure |
|---|---|
| The array initialization must not be used with more than 16 entries. | Use <code>constant array</code> instead. |
| Too many local variables and arrays within functions may result in a stack overflow. | Declare the variables globally. Memory requirements are monitored already during compilation; errors do not occur at runtime. |
| Functions that are too deeply nested may result in a stack overflow. | Observe a maximum nesting depth of 2. |
| <code>float</code> must not be used with comparison operators. | Use <code>int</code> instead. |
| <code>double</code> must not be used. | |
| If a NanoJ program restarts the controller (either directly with an explicit restart or indirectly, e. g., through the use of the Reset function), the controller may fall into a restart loop that can be exited only with difficulty if at all. | |
| <code>math</code> or <code>cmath</code> cannot be included. | |

10 Description of the object dictionary

10.1 Overview

This chapter contains a description of all objects.

You will find information here on:

- Functions
- Object descriptions ("Index")
- Value descriptions ("Subindices")
- Descriptions of bits
- Description of the object

10.2 Structure of the object description

The description of the object entries always has the same structure and usually consists of the following sections:

Function

The function of the object dictionary is briefly described in this section.

Object description

This table provides detailed information on the data type, preset values and similar. An exact description can be found in section "[Object description](#)"

Value description

This table is only available with the "Array" or "Record" data type and provides exact information about the sub-entries. A more exact description of the entries can be found in section "[Value description](#)"

Description

Here, more exact information on the individual bits of an entry is provided or any compositions explained. A more exact description can be found in section "[Description](#)"

10.3 Object description

The object description consists of a table that contains the following entries:

Index

Designates the object index in hexadecimal notation.

Object name

The name of the object.

Object Code

The type of object. This can be one of the following entries:

- VARIABLE: In this case, the object consists of only a variable that is indexed with subindex 0.
- ARRAY: These objects always consists of a subindex 0 – which specifies the number of sub-entries – and the sub-entries themselves, beginning with index 1. The data type within an array never changes, i.e., sub-entry 1 and all subsequent entries are always of the same data type.
- RECORD: These objects always consists of a subindex 0 – which specifies the number of sub-entries – and the sub-entries themselves, beginning with index 1. Unlike an ARRAY, the data type of the sub-entries can vary. This means that, e.g., sub-entry 1 may be of a different data type than sub-entry 2.

- **VISIBLE_STRING**: The object describes a character string coded in ASCII. The length of the string is specified in subindex 0; the individual characters are stored beginning in subindex 1. These character strings are **not** terminated by a null character.

Data type

The size and interpretation of the object is specified here. The following notation is used for the "VARIABLE" object code:

- A distinction is made between entries that are signed; these are designated with the prefix "SIGNED". For entries that are unsigned, the prefix "UNSIGNED" is used.
- The size of the variable in bits is placed before the prefix and can be 8, 16 or 32.

Savable

Described here is whether this object is savable and, if so, in which category.

Firmware version

The firmware version beginning with which the object is available is entered here.

Change history (ChangeLog)

Any changes to the object are noted here.

There are also the following table entries for the "VARIABLE" data type:

Access

The access restriction is entered here. The following restrictions are available:

- "read/write": The object can both be read as well as written
- "read only": The object can only be read from the object dictionary. It is not possible to set a value.

PDO mapping

Some bus systems, such as CANopen or EtherCAT, support PDO mapping. Described in this table entry is whether the object can be inserted into a mapping and, if so, into which. The following designations are available here:

- "no": The object may not be entered in a mapping.
- "TX-PDO": The object may be entered in an RX mapping.
- "RX-PDO": The object may be entered in a TX mapping.

Allowed values

In some cases, only certain values may be written in the object. If this is the case, these values are listed here. If there are no restrictions, the field is empty.

Preset value

To bring the controller to a secured state when switching on, it is necessary to preset a number of objects with values. The value that is written in the object when the controller is started is noted in this table entry.

10.4 Value description

NOTICE



For the sake of clarity, a number of subindices are grouped together if the entries all have the same name.

Listed in the table with the "Value description" heading are all data for sub-entries with subindex 1 or higher. The table contains the following entries:

Subindex

Number of the currently written sub-entry.

Name

Name of the sub-entry.

Data type

The size and interpretation of the sub-entry is specified here. The following notation always applies here:

- A distinction is made between entries that are signed; these are designated with the prefix "SIGNED". For entries that are unsigned, the prefix "UNSIGNED" is used.
- The size of the variable in bits is placed before the prefix and can be 8, 16 or 32.

Access

The access restriction for the sub-entry is entered here. The following restrictions are available:

- "read/write": The object can both be read as well as written
- "read only": The object can only be read from the object dictionary. It is not possible to set a value.

PDO mapping

Some bus systems, such as CANopen or EtherCAT, support PDO mapping. Described in this table entry is whether the sub-entry can be inserted into a mapping and, if so, into which. The following designations are available here:

- "no": The object may not be entered in a mapping.
- "TX-PDO": The object may be entered in an RX mapping.
- "RX-PDO": The object may be entered in a TX mapping.

Allowed values

In some cases, only certain values may be written in the sub-entry. If this is the case, these values are listed here. If there are no restrictions, the field is empty.

Preset value

To bring the controller to a secured state when switching on, it is necessary to preset a number of sub-entries with values. The value that is written in the sub-entry when the controller is started is noted in this table entry.

10.5 Description

This section may be present if use requires additional information. If individual bits of an object or sub-entry have different meaning, diagrams as shown in the following example are used.

Example: The object is 8 bits in size; bit 0 and bit 1 have different functions. Bits 2 and 3 are grouped into one function; the same applies for bits 4 to 7.

| | | | | | | | |
|-------------|---|---|---|-------------|---|---|---|
| 7 | 6 | 5 | 4 | 3 | 2 | 1 | 0 |
| Example [4] | | | | Example [2] | | B | A |

Example [4]

Description of bit 4 up to and including bit 7; these bits are logically related. The 4 in square brackets specifies the number of related bits. A list with possible values and their description is often attached at this point.

Example [2]

Description of bits 3 and 2; these bits are logically related. The 2 in square brackets specifies the number of related bits.

- Value 00_b: The description here applies if bit 2 and bit 3 are "0".
- Value 01_b: The description here applies if bit 2 is "0" and bit 3 is "1".
- Value 10_b: The description here applies if bit 2 is "1" and bit 3 is "0".
- Value 11_b: The description here applies if bit 2 and bit 3 are "1".

B

Description of bit B; no length is specified for a single bit.

A

Description of bit A; bits with a gray background are not used.

1000h Device Type**Function**

Describes the controller type.

Object description

| | |
|------------------|-----------------------|
| Index | 1000 _h |
| Object name | Device Type |
| Object Code | VARIABLE |
| Data type | UNSIGNED32 |
| Savable | no |
| Access | read only |
| PDO mapping | no |
| Allowed values | |
| Preset value | 00060192 _h |
| Firmware version | FIR-v1426 |
| Change history | |

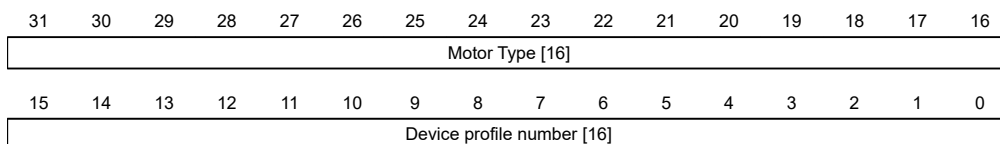
Description**Motor Type[16]**

Describes the supported motor type. The following values are possible:

- Bit 23 to bit 16: Value "2": BLDC motor
- Bit 23 to bit 16: Value "4": Stepper motor
- Bit 23 to bit 16: Value "6": Stepper motor as well as BLDC motor

Device profile number[16]

Describes the supported CANopen standard.

Values:

0192_h or 0402_d (preset value): The CiA 402 standard is supported.

1001h Error Register

Function

Error register: In the event of an error, the corresponding error bit(s) is/are set. If the error no longer exists, it is deleted automatically.



NOTICE

For each error that occurs, a more precise error code is stored in object 1003_h.

Object description

| | |
|------------------|-------------------|
| Index | 1001 _h |
| Object name | Error Register |
| Object Code | VARIABLE |
| Data type | UNSIGNED8 |
| Savable | no |
| Access | read only |
| PDO mapping | TX-PDO |
| Allowed values | |
| Preset value | 00 _h |
| Firmware version | FIR-v1426 |
| Change history | |

Description

| | | | | | | | |
|-----|-----|------|-----|------|-----|-----|-----|
| 7 | 6 | 5 | 4 | 3 | 2 | 1 | 0 |
| MAN | RES | PROF | COM | TEMP | VOL | CUR | GEN |

GEN

General error, always set in the event of an error

CUR

Current

VOL

Voltage

TEMP

Temperature

COM

Communication

PROF

Relates to the device profile

RES

Reserved, always "0"

MAN

Manufacturer-specific

1003h Pre-defined Error Field**Function**

This object contains an error stack with up to eight entries.

Object description

| | |
|------------------|-------------------------|
| Index | 1003 _h |
| Object name | Pre-defined Error Field |
| Object Code | ARRAY |
| Data type | UNSIGNED32 |
| Savable | no |
| Firmware version | FIR-v1426 |
| Change history | |

Value description

| | |
|----------------|------------------|
| Subindex | 00 _h |
| Name | Number Of Errors |
| Data type | UNSIGNED8 |
| Access | read / write |
| PDO mapping | no |
| Allowed values | |
| Preset value | 00 _h |

| | |
|----------------|--------------------------|
| Subindex | 01 _h |
| Name | 1st Standard Error Field |
| Data type | UNSIGNED32 |
| Access | read only |
| PDO mapping | no |
| Allowed values | |
| Preset value | 00000000 _h |

| | |
|----------------|--------------------------|
| Subindex | 02 _h |
| Name | 2nd Standard Error Field |
| Data type | UNSIGNED32 |
| Access | read only |
| PDO mapping | no |
| Allowed values | |

| | |
|----------------|--------------------------|
| Preset value | 00000000 _h |
| Subindex | 03 _h |
| Name | 3th Standard Error Field |
| Data type | UNSIGNED32 |
| Access | read only |
| PDO mapping | no |
| Allowed values | |
| Preset value | 00000000 _h |
| Subindex | 04 _h |
| Name | 4th Standard Error Field |
| Data type | UNSIGNED32 |
| Access | read only |
| PDO mapping | no |
| Allowed values | |
| Preset value | 00000000 _h |
| Subindex | 05 _h |
| Name | 5th Standard Error Field |
| Data type | UNSIGNED32 |
| Access | read only |
| PDO mapping | no |
| Allowed values | |
| Preset value | 00000000 _h |
| Subindex | 06 _h |
| Name | 6th Standard Error Field |
| Data type | UNSIGNED32 |
| Access | read only |
| PDO mapping | no |
| Allowed values | |
| Preset value | 00000000 _h |
| Subindex | 07 _h |
| Name | 7th Standard Error Field |
| Data type | UNSIGNED32 |
| Access | read only |
| PDO mapping | no |
| Allowed values | |
| Preset value | 00000000 _h |
| Subindex | 08 _h |

| | |
|----------------|--------------------------|
| Name | 8th Standard Error Field |
| Data type | UNSIGNED32 |
| Access | read only |
| PDO mapping | no |
| Allowed values | |
| Preset value | 00000000 _h |

Description

General function

If a new error occurs, it is entered in subindex 1. The already existing entries in subindices 1 to 7 are moved back one position. The error in subindex 7 is thereby removed.

The number of errors that have already occurred can be read from the object with subindex 0. If no error is currently entered in the error stack, it is not possible to read one of the eight subindices 1–8 and an error (abort code = 08000024_h) is sent in response. If a "0" is written in subindex 0, counting starts again from the beginning.

Bit description

| | | | | | | | | | | | | | | | |
|------------------|----|----|----|----|----|----|----|-----------------|----|----|----|----|----|----|----|
| 31 | 30 | 29 | 28 | 27 | 26 | 25 | 24 | 23 | 22 | 21 | 20 | 19 | 18 | 17 | 16 |
| Error Number [8] | | | | | | | | Error Class [8] | | | | | | | |
| 15 | 14 | 13 | 12 | 11 | 10 | 9 | 8 | 7 | 6 | 5 | 4 | 3 | 2 | 1 | 0 |
| Error Code [16] | | | | | | | | | | | | | | | |

Error Number [8]

This can be used to pinpoint the cause of the error. The meaning of the number can be found in the following table.

| Error number | Description |
|--------------|---|
| 0 | Watchdog-Reset |
| 1 | Input voltage (+Ub) too high |
| 2 | Output current too high |
| 3 | Input voltage (+Ub) too low |
| 4 | Error at fieldbus |
| 6 | CANopen only: NMT master takes too long to send Nodeguarding request |
| 7 | Sensor 1 (see 3204 _h): Error through electrical fault or defective hardware |
| 8 | Sensor 2 (see 3204 _h): Error through electrical fault or defective hardware |
| 9 | Sensor 3 (see 3204 _h): Error through electrical fault or defective hardware |
| 10 | Warning: Positive limit switch exceeded |
| 11 | Warning: Negative limit switch exceeded |
| 12 | Overtemperature error |
| 13 | The values of object 6065 _h (Following Error Window) and object 6066 _h (Following Error Time Out) were exceeded; a fault was triggered. |
| 14 | Warning: Nonvolatile memory full. The current save process could not be completed; parts of the data of the save process are lost. Controller must be restarted for cleanup work. |
| 15 | Motor blocked |
| 16 | Warning: Nonvolatile memory damaged; controller must be restarted for cleanup work (all saved objects are reset to default). |
| 17 | CANopen only: Slave took too long to send PDO messages. |

| Error number | Description |
|--------------|---|
| 18 | Sensor n (see 3204_h), where n is greater than 3: Error through electrical fault or defective hardware |
| 19 | CANopen only: PDO not processed due to a length error |
| 20 | CANopen only: PDO length exceeded |
| 21 | Warning: Restart the controller to avoid future errors when saving (nonvolatile memory full/corrupt). |
| 22 | Rated current must be set (203B_h:01_h/6075_h) |
| 23 | Encoder resolution, number of pole pairs and some other values are incorrect. |
| 24 | Motor current is too high, adjust the PI parameters. |
| 25 | Internal software error, generic |
| 26 | Current too high at digital output |
| 27 | CANopen only: Unexpected sync length |
| 30 | Error in speed monitoring: slippage error too large |
| 32 | Internal error: Correction factor for reference voltage missing in the OTP |
| 40 | Warning: Ballast resistor thermally overloaded |
| 41 | Only EtherCAT: <i>Sync Manager Watchdog</i> : The controller has not received any PDO data for an excessively long period of time; check the software and hardware connections. |
| 46 | Interlock error: Bit 3 in 60FD_h is set to "0", the motor may not start |
| 48 | Only CANopen: NMT status has been set to <i>stopped</i> |

Error Class[8]

This byte is identical to object [1001_h](#)

Error Code[16]

Refer to the following table for the meaning of the bytes.

| Error Code | Description |
|-------------------|--|
| 1000 _h | General error |
| 2300 _h | Current at the controller output too large |
| 3100 _h | Overvoltage/undervoltage at controller input |
| 4200 _h | Temperature error within the controller |
| 5440 _h | Interlock error: Bit 3 in 60FD_h is set to "0", the motor may not start (see the section <i>Interlock function</i> in the chapter Digital inputs) |
| 6010 _h | Software reset (watchdog) |
| 6100 _h | Internal software error, generic |
| 6320 _h | Rated current must be set (203B_h:01_h/6075_h) |
| 7113 _h | Warning: Ballast resistor thermally overloaded |
| 7121 _h | Motor blocked |
| 7200 _h | Internal error: Correction factor for reference voltage missing in the OTP |
| 7305 _h | Sensor 1 (see 3204_h) faulty |
| 7306 _h | Sensor 2 (see 3204_h) faulty |
| 7307 _h | Sensor n (see 3204_h), where n is greater than 2 |

| Error Code | Description |
|-------------------|--|
| 7600 _h | Warning: Nonvolatile memory full or corrupt; restart the controller for cleanup work |
| 8100 _h | Error during fieldbus monitoring |
| 8130 _h | CANopen only: "Life Guard" error or "Heartbeat" error |
| 8200 _h | CANopen only: Slave took too long to send PDO messages. |
| 8210 _h | CANopen only: PDO was not processed due to a length error |
| 8220 _h | CANopen only: PDO length exceeded |
| 8240 _h | CANopen only: unexpected sync length |
| 8400 _h | Error in speed monitoring: slippage error too large |
| 8611 _h | Position monitoring error: Following error too large |
| 8612 _h | Position monitoring error: Limit switch exceeded |

1005h COB-ID Sync

Function

Defines the COB-ID of the SYNC message for the SYNC protocol. The value must correspond to an 11-bit-long CAN-ID and is evaluated when the controller is restarted or on a Reset Communication command.

NOTICE



If the CAN-ID is not to correspond to the default value of 80_h, it must be ensured that only not-yet unassigned or reserved CAN-IDs are used.

You can activate the generation of sync messages (the controller becomes the *sync master of the network*) by setting bit 30 to "1". Set the cycle time in object 1006_h.

Object description

| | |
|------------------|------------------------------|
| Index | 1005 _h |
| Object name | COB-ID Sync |
| Object Code | VARIABLE |
| Data type | UNSIGNED32 |
| Savable | yes, category: communication |
| Access | read / write |
| PDO mapping | no |
| Allowed values | |
| Preset value | 00000080 _h |
| Firmware version | FIR-v1426 |
| Change history | |

1006h Communication Cycle Period

Function

Contains the cycle time for the generated sync messages (see [1005_h](#)) in μ s. Only multiples of 1000 μ s are permitted.

Object description

| | |
|------------------|------------------------------|
| Index | 1006 _h |
| Object name | Communication Cycle Period |
| Object Code | VARIABLE |
| Data type | UNSIGNED32 |
| Savable | yes, category: communication |
| Access | read / write |
| PDO mapping | no |
| Allowed values | |
| Preset value | 00000000 _h |
| Firmware version | FIR-v2013-B726332 |
| Change history | |

1007h Synchronous Window Length

Function

This object contains the length of the time window in microseconds for synchronous PDOs. If the synchronous time window has elapsed, all synchronous TxPDOs are rejected. The RxPDOs are also rejected up to the next SYNC message.

The value "0" switches off the time window, thereby allowing the PDOs to be sent at any time.

This object is only available in device variants with CANopen connection.

Object description

| | |
|------------------|------------------------------|
| Index | 1007 _h |
| Object name | Synchronous Window Length |
| Object Code | VARIABLE |
| Data type | UNSIGNED32 |
| Savable | yes, category: communication |
| Access | read / write |
| PDO mapping | no |
| Allowed values | |
| Preset value | 00000000 _h |
| Firmware version | FIR-v1426 |
| Change history | |

1008h Manufacturer Device Name

Function

Contains the device name as character string.

Object description

| | |
|------------------|--|
| Index | 1008 _h |
| Object name | Manufacturer Device Name |
| Object Code | VARIABLE |
| Data type | VISIBLE_STRING |
| Savable | no |
| Access | read only |
| PDO mapping | no |
| Allowed values | |
| Preset value | <ul style="list-style-type: none"> ■ PD1-C281S15-E-20-2: PD1-C281S15-E-20-2 ■ PD1-C281S15-E-20-5: PD1-C281S15-E-20-5 ■ PD1-C281S15-E-65-2: PD1-C281S15-E-65-2 ■ PD1-C281S15-E-65-5: PD1-C281S15-E-65-5 ■ PD1-C281S15-E-OF-2: PD1-C281S15-E-OF-2 ■ PD1-C281S15-E-OF-5: PD1-C281S15-E-OF-5 ■ PD1-C281L15-E-20-2: PD1-C281L15-E-20-2 ■ PD1-C281L15-E-20-5: PD1-C281L15-E-20-5 ■ PD1-C281L15-E-65-2: PD1-C281L15-E-65-2 ■ PD1-C281L15-E-65-5: PD1-C281L15-E-65-5 ■ PD1-C281L15-E-OF-2: PD1-C281L15-E-OF-2 ■ PD1-C281L15-E-OF-5: PD1-C281L15-E-OF-5 |
| Firmware version | FIR-v1426 |
| Change history | |

1009h Manufacturer Hardware Version

Function

This object contains the hardware version as character string.

Object description

| | |
|------------------|-------------------------------|
| Index | 1009 _h |
| Object name | Manufacturer Hardware Version |
| Object Code | VARIABLE |
| Data type | VISIBLE_STRING |
| Savable | no |
| Access | read only |
| PDO mapping | no |
| Allowed values | |
| Preset value | 0 |
| Firmware version | FIR-v1426 |

Change history

100Ah Manufacturer Software Version

Function

This object contains the software version as character string.

Object description

| | |
|------------------|-------------------------------|
| Index | 100A _h |
| Object name | Manufacturer Software Version |
| Object Code | VARIABLE |
| Data type | VISIBLE_STRING |
| Savable | no |
| Access | read only |
| PDO mapping | no |
| Allowed values | |
| Preset value | FIR-v2425-B1060841 |
| Firmware version | FIR-v1426 |
| Change history | |

100Ch Guard Time

Function

Object 100C_h multiplied by object [100Dh Live Time Factor](#) yields the so-called lifetime for the Lifeguarding / Nodeguarding protocol. The value is specified in milliseconds. See also [Nodeguarding](#).

NOTICE



The *Heartbeat protocol* has a higher priority than *Nodeguarding*. If both protocols are activated simultaneously, the Node Guarding Timer is suppressed, but no EMCY message is sent either.

Object description

| | |
|------------------|------------------------------|
| Index | 100C _h |
| Object name | Guard Time |
| Object Code | VARIABLE |
| Data type | UNSIGNED16 |
| Savable | yes, category: communication |
| Access | read / write |
| PDO mapping | no |
| Allowed values | |
| Preset value | 0000 _h |
| Firmware version | FIR-v1426 |
| Change history | |

100Dh Live Time Factor

Function

This object is a multiplier which, multiplied by object `100Ch`, yields the time window for the *Nodeguarding* protocol in milliseconds. See also [Nodeguarding](#).

NOTICE



The *Heartbeat protocol* has a higher priority than *Nodeguarding*. If both protocols are activated simultaneously, the Node Guarding Timer is suppressed, but no EMCY message is sent either.

This object is only available in device variants with CANopen connection.

Object description

| | |
|------------------|------------------------------|
| Index | 100D _h |
| Object name | Live Time Factor |
| Object Code | VARIABLE |
| Data type | UNSIGNED8 |
| Savable | yes, category: communication |
| Access | read / write |
| PDO mapping | no |
| Allowed values | |
| Preset value | 00 _h |
| Firmware version | FIR-v1426 |
| Change history | |

1010h Store Parameters

Function

This object is used to start the saving of objects. See chapter [Saving objects](#).

Object description

| | |
|------------------|---|
| Index | 1010 _h |
| Object name | Store Parameters |
| Object Code | ARRAY |
| Data type | UNSIGNED32 |
| Savable | no |
| Access | read only |
| PDO mapping | no |
| Allowed values | |
| Preset value | |
| Firmware version | FIR-v1426 |
| Change history | Firmware version FIR-v1436: "Object name" entry changed from "Store Parameter" to "Store Parameters". |

Firmware version FIR-v1436: The number of entries was changed from 3 to 4.

Firmware version FIR-v1512: The number of entries was changed from 4 to 5.

Firmware version FIR-v1540: The number of entries was changed from 5 to 7.

Firmware version FIR-v1738-B501312: The number of entries was changed from 7 to 14.

Firmware version FIR-v2412-B1057638: entry "Name" changed from "Save Miscellaneous Configurations To Non-volatile Memory" to "Save Reserved0 Configurations To Non-volatile Memory".

Value description

| | |
|----------------|-------------------|
| Subindex | 00 _h |
| Name | Number Of Entries |
| Data type | UNSIGNED8 |
| Access | read only |
| PDO mapping | no |
| Allowed values | |
| Preset value | 0D _h |

| | |
|----------------|--|
| Subindex | 01 _h |
| Name | Save All Parameters To Non-volatile Memory |
| Data type | UNSIGNED32 |
| Access | read / write |
| PDO mapping | no |
| Allowed values | |
| Preset value | 00000001 _h |

| | |
|----------------|--|
| Subindex | 02 _h |
| Name | Save Communication Parameters To Non-volatile Memory |
| Data type | UNSIGNED32 |
| Access | read / write |
| PDO mapping | no |
| Allowed values | |
| Preset value | 00000001 _h |

| | |
|----------------|--|
| Subindex | 03 _h |
| Name | Save Application Parameters To Non-volatile Memory |
| Data type | UNSIGNED32 |
| Access | read / write |
| PDO mapping | no |
| Allowed values | |

| | |
|----------------|--|
| Preset value | 00000001 _h |
| Subindex | 04 _h |
| Name | Save Customer Parameters To Non-volatile Memory |
| Data type | UNSIGNED32 |
| Access | read / write |
| PDO mapping | no |
| Allowed values | |
| Preset value | 00000001 _h |
| Subindex | 05 _h |
| Name | Save Drive Parameters To Non-volatile Memory |
| Data type | UNSIGNED32 |
| Access | read / write |
| PDO mapping | no |
| Allowed values | |
| Preset value | 00000001 _h |
| Subindex | 06 _h |
| Name | Save Tuning Parameters To Non-volatile Memory |
| Data type | UNSIGNED32 |
| Access | read / write |
| PDO mapping | no |
| Allowed values | |
| Preset value | 00000001 _h |
| Subindex | 07 _h |
| Name | Save Reserved0 Configurations To Non-volatile Memory |
| Data type | UNSIGNED32 |
| Access | read / write |
| PDO mapping | no |
| Allowed values | |
| Preset value | 00000000 _h |
| Subindex | 08 _h |
| Name | Save Reserved1 Configurations To Non-volatile Memory |
| Data type | UNSIGNED32 |
| Access | read / write |
| PDO mapping | no |
| Allowed values | |
| Preset value | 00000000 _h |
| Subindex | 09 _h |

| | |
|----------------|---|
| Name | Save Reserved2 Configurations To Non-volatile Memory |
| Data type | UNSIGNED32 |
| Access | read / write |
| PDO mapping | no |
| Allowed values | |
| Preset value | 00000000 _h |
| <hr/> | |
| Subindex | 0A _h |
| Name | Save CANopen Configurations To Non-volatile Memory |
| Data type | UNSIGNED32 |
| Access | read / write |
| PDO mapping | no |
| Allowed values | |
| Preset value | 00000001 _h |
| <hr/> | |
| Subindex | 0B _h |
| Name | Save Modbus RTU Configurations To Non-volatile Memory |
| Data type | UNSIGNED32 |
| Access | read / write |
| PDO mapping | no |
| Allowed values | |
| Preset value | 00000001 _h |
| <hr/> | |
| Subindex | 0C _h |
| Name | Save Ethernet Configurations To Non-volatile Memory |
| Data type | UNSIGNED32 |
| Access | read / write |
| PDO mapping | no |
| Allowed values | |
| Preset value | 00000001 _h |
| <hr/> | |
| Subindex | 0D _h |
| Name | Save Profibus Configurations To Non-volatile Memory |
| Data type | UNSIGNED32 |
| Access | read / write |
| PDO mapping | no |
| Allowed values | |
| Preset value | 00000001 _h |

Description

Each subindex of the object stands for a certain memory class. By reading out the entry, it is possible to determine whether (value "1") or not (value="0") this memory category can be saved.

To start the save process of a memory category, value "65766173_h" must be written in the corresponding subindex. This corresponds to the decimal of 1702257011_d or the ASCII string `save`. As soon as the saving

process is completed, the save command is again overwritten with the value "1", since saving is possible again.

For a detailed description, see chapter [Saving objects](#).

1011h Restore Default Parameters

Function

This object can be used to reset all or part of the object dictionary to the default values. See chapter [Saving objects](#).

Object description

| | |
|------------------|---|
| Index | 1011 _h |
| Object name | Restore Default Parameters |
| Object Code | ARRAY |
| Data type | UNSIGNED32 |
| Savable | no |
| Access | read only |
| PDO mapping | no |
| Allowed values | |
| Preset value | |
| Firmware version | FIR-v1426 |
| Change history | <p>Firmware version FIR-v1436: "Object Name" entry changed from "Restore Default Parameter" to "Restore Default Parameters".</p> <p>Firmware version FIR-v1436: The number of entries was changed from 2 to 4.</p> <p>Firmware version FIR-v1512: The number of entries was changed from 4 to 5.</p> <p>Firmware version FIR-v1512: "Name" entry changed from "Restore The Comm Default Parameters" to "Restore Communication Default Parameters".</p> <p>Firmware version FIR-v1512: "Name" entry changed from "Restore The Application Default Parameters" to "Restore Application Default Parameters".</p> <p>Firmware version FIR-v1540: The number of entries was changed from 5 to 7.</p> <p>Firmware version FIR-v1738-B501312: The number of entries was changed from 7 to 14.</p> <p>Firmware version FIR-v2412-B1057638: entry "Name" changed from "Restore Miscellaneous Configurations" to "Restore Reserved0 Configurations To Non-volatile Memory".</p> |

Value description

| | |
|-----------|-------------------|
| Subindex | 00 _h |
| Name | Number Of Entries |
| Data type | UNSIGNED8 |

| | |
|----------------|-----------------|
| Access | read only |
| PDO mapping | no |
| Allowed values | |
| Preset value | 0D _h |

| | |
|----------------|--------------------------------|
| Subindex | 01 _h |
| Name | Restore All Default Parameters |
| Data type | UNSIGNED32 |
| Access | read / write |
| PDO mapping | no |
| Allowed values | |
| Preset value | 00000001 _h |

| | |
|----------------|--|
| Subindex | 02 _h |
| Name | Restore Communication Default Parameters |
| Data type | UNSIGNED32 |
| Access | read / write |
| PDO mapping | no |
| Allowed values | |
| Preset value | 00000001 _h |

| | |
|----------------|--|
| Subindex | 03 _h |
| Name | Restore Application Default Parameters |
| Data type | UNSIGNED32 |
| Access | read / write |
| PDO mapping | no |
| Allowed values | |
| Preset value | 00000001 _h |

| | |
|----------------|-------------------------------------|
| Subindex | 04 _h |
| Name | Restore Customer Default Parameters |
| Data type | UNSIGNED32 |
| Access | read / write |
| PDO mapping | no |
| Allowed values | |
| Preset value | 00000001 _h |

| | |
|----------------|----------------------------------|
| Subindex | 05 _h |
| Name | Restore Drive Default Parameters |
| Data type | UNSIGNED32 |
| Access | read / write |
| PDO mapping | no |
| Allowed values | |

| | |
|----------------|---|
| Preset value | 00000001 _h |
| Subindex | 06 _h |
| Name | Restore Tuning Default Parameters |
| Data type | UNSIGNED32 |
| Access | read / write |
| PDO mapping | no |
| Allowed values | |
| Preset value | 00000001 _h |
| Subindex | 07 _h |
| Name | Restore Reserved0 Configurations To Non-volatile Memory |
| Data type | UNSIGNED32 |
| Access | read / write |
| PDO mapping | no |
| Allowed values | |
| Preset value | 00000000 _h |
| Subindex | 08 _h |
| Name | Restore Reserved1 Configurations To Non-volatile Memory |
| Data type | UNSIGNED32 |
| Access | read / write |
| PDO mapping | no |
| Allowed values | |
| Preset value | 00000000 _h |
| Subindex | 09 _h |
| Name | Restore Reserved2 Configurations To Non-volatile Memory |
| Data type | UNSIGNED32 |
| Access | read / write |
| PDO mapping | no |
| Allowed values | |
| Preset value | 00000000 _h |
| Subindex | 0A _h |
| Name | Restore CANopen Configurations To Non-volatile Memory |
| Data type | UNSIGNED32 |
| Access | read / write |
| PDO mapping | no |
| Allowed values | |
| Preset value | 00000001 _h |
| Subindex | 0B _h |

| | |
|----------------|--|
| Name | Restore Modbus RTU Configurations To Non-volatile Memory |
| Data type | UNSIGNED32 |
| Access | read / write |
| PDO mapping | no |
| Allowed values | |
| Preset value | 00000001 _h |

| | |
|----------------|--|
| Subindex | 0C _h |
| Name | Restore Ethernet Configurations To Non-volatile Memory |
| Data type | UNSIGNED32 |
| Access | read / write |
| PDO mapping | no |
| Allowed values | |
| Preset value | 00000001 _h |

| | |
|----------------|--|
| Subindex | 0D _h |
| Name | Restore Profibus Configurations To Non-volatile Memory |
| Data type | UNSIGNED32 |
| Access | read / write |
| PDO mapping | no |
| Allowed values | |
| Preset value | 00000001 _h |

Description

If the value 64616F6C_h (or 1684107116_d or ASCII `load`) is written in this object, part or all of the object dictionary is reset to the default values. The subindex that is used decides which range is reset.

For a detailed description, see chapter [Discarding the saved data](#).

1014h COB-ID EMCY

Function

This object describes the COB-ID of the "Emergency Service" under CANopen.

With the *Valid Bit* (bit 31) = "1", the [Emergency Service](#) can be deactivated; the service is active with the value "0". Every time the controller is restarted, bits 0 to 30 are generated according to the node-ID.

Object description

| | |
|----------------|------------------------------|
| Index | 1014 _h |
| Object name | COB-ID EMCY |
| Object Code | VARIABLE |
| Data type | UNSIGNED32 |
| Savable | yes, category: communication |
| Access | read / write |
| PDO mapping | no |
| Allowed values | |

| | |
|------------------|--|
| Preset value | 00000000 _h |
| Firmware version | FIR-v1426 |
| Change history | Firmware version FIR-v1540: "Access" table entry for subindex 00 changed from "read only" to "read/write". |

1016h Consumer Heartbeat Time

Function

This object defines the cycle time of the *Consumer Heartbeat* of the *Network Management* CANopen service and the Node-ID of the *Producer* of the *Heartbeat*.

If the cycle time or node-ID is set to the value 0, there is no response to the Heartbeat message. See also chapter [Heartbeat](#).

Object description

| | |
|------------------|------------------------------|
| Index | 1016 _h |
| Object name | Consumer Heartbeat Time |
| Object Code | ARRAY |
| Data type | UNSIGNED32 |
| Savable | yes, category: communication |
| Access | read only |
| PDO mapping | no |
| Allowed values | |
| Preset value | |
| Firmware version | FIR-v1738-B501312 |
| Change history | |

Value description

| | |
|----------------|-------------------|
| Subindex | 00 _h |
| Name | Number Of Entries |
| Data type | UNSIGNED8 |
| Access | read only |
| PDO mapping | no |
| Allowed values | |
| Preset value | 01 _h |

| | |
|----------------|-------------------------|
| Subindex | 01 _h |
| Name | Consumer Heartbeat Time |
| Data type | UNSIGNED32 |
| Access | read / write |
| PDO mapping | no |
| Allowed values | |
| Preset value | 00000000 _h |

Description

Subindex 01_h contains:

- Bits 0 to 15: The time of the *Consumer Heartbeat* in ms.
- Bits 16 to 23: The node-ID of the *Producer* whose *Heartbeat* is to be monitored.

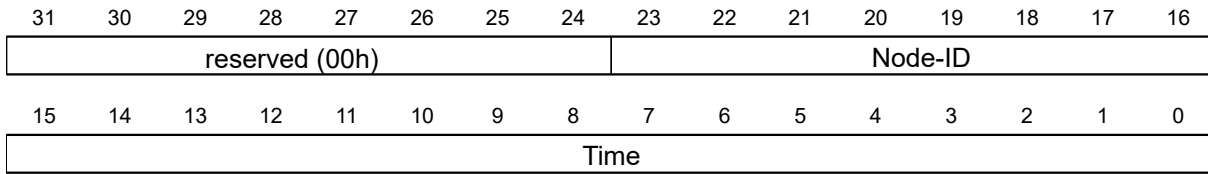

1017h Producer Heartbeat Time

Function

This object defines the cycle time of the *Heartbeat* of the *Network Management* CANopen service in milliseconds. If the object is set to the value 0, no Heartbeat message is sent. See also [Heartbeat](#).

NOTICE



The *Heartbeat protocol* has a higher priority than *Nodeguarding*. If both protocols are activated simultaneously, the Node Guarding Timer is suppressed, but no EMCY message is sent either.

This object is only available in device variants with CANopen connection.

Object description

| | |
|------------------|------------------------------|
| Index | 1017 _h |
| Object name | Producer Heartbeat Time |
| Object Code | VARIABLE |
| Data type | UNSIGNED16 |
| Savable | yes, category: communication |
| Access | read / write |
| PDO mapping | no |
| Allowed values | |
| Preset value | 0000 _h |
| Firmware version | FIR-v1426 |
| Change history | |

1018h Identity Object

Function

This object returns general information on the device, such as manufacturer, product code, revision and serial number.



TIP

Have these values ready in the event of service inquiries.

Object description

| | |
|------------------|-------------------|
| Index | 1018 _h |
| Object name | Identity Object |
| Object Code | RECORD |
| Data type | IDENTITY |
| Savable | no |
| Firmware version | FIR-v1426 |
| Change history | |

Value description

| | |
|----------------|-------------------|
| Subindex | 00 _h |
| Name | Number Of Entries |
| Data type | UNSIGNED8 |
| Access | read only |
| PDO mapping | no |
| Allowed values | |
| Preset value | 04 _h |

| | |
|----------------|-----------------------|
| Subindex | 01 _h |
| Name | Vendor ID |
| Data type | UNSIGNED32 |
| Access | read only |
| PDO mapping | no |
| Allowed values | |
| Preset value | 0000026C _h |

| | |
|----------------|--|
| Subindex | 02 _h |
| Name | Product Code |
| Data type | UNSIGNED32 |
| Access | read only |
| PDO mapping | no |
| Allowed values | |
| Preset value | <ul style="list-style-type: none"> ■ PD1-C281S15-E-20-2: 00210100_h ■ PD1-C281S15-E-20-5: 00210102_h ■ PD1-C281S15-E-65-2: 00210200_h ■ PD1-C281S15-E-65-5: 00210202_h ■ PD1-C281S15-E-OF-2: 00210300_h ■ PD1-C281S15-E-OF-5: 00210302_h ■ PD1-C281L15-E-20-2: 00230100_h ■ PD1-C281L15-E-20-5: 00230102_h ■ PD1-C281L15-E-65-2: 00230200_h ■ PD1-C281L15-E-65-5: 00230202_h ■ PD1-C281L15-E-OF-2: 00230300_h |

■ PD1-C281L15-E-OF-5: 00230302_h

| | |
|----------------|-----------------------|
| Subindex | 03 _h |
| Name | Revision Number |
| Data type | UNSIGNED32 |
| Access | read only |
| PDO mapping | no |
| Allowed values | |
| Preset value | 09790000 _h |

| | |
|----------------|-----------------------|
| Subindex | 04 _h |
| Name | Serial Number |
| Data type | UNSIGNED32 |
| Access | read only |
| PDO mapping | no |
| Allowed values | |
| Preset value | 00000000 _h |

1019h Synchronous Counter Overflow Value

Function

The value from which the *Sync Counter* is to begin counting anew is entered here. See chapter [Synchronization object \(SYNC\)](#).

Object description

| | |
|------------------|--|
| Index | 1019 _h |
| Object name | Synchronous Counter Overflow Value |
| Object Code | VARIABLE |
| Data type | UNSIGNED8 |
| Savable | yes, category: communication |
| Access | read / write |
| PDO mapping | no |
| Allowed values | |
| Preset value | 00 _h |
| Firmware version | FIR-v1426 |
| Change history | <p>Firmware Version FIR-v1738-B501312: "Object Name" entry changed from "Synchronous counter overflow value" to "Synchronous Counter Overflow Value".</p> <p>Firmware version FIR-v1738-B501312: "Data type" entry changed from "UNSIGNED16" to "UNSIGNED8".</p> |

Description

Allowed values: 02_h to F0_h and 0. If the value is "0", the sync message is transmitted as a CAN message with a data length of 0.

1020h Verify Configuration

Function

This object indicates the date and time that the configuration was stored.

A configuration tool or a master can use this object to verify the configuration after a reset and, if necessary, perform a new configuration.

The tool must set the date and time before the storage mechanism is started (see chapter [Saving objects](#)).

Object description

| | |
|------------------|-----------------------|
| Index | 1020 _h |
| Object name | Verify Configuration |
| Object Code | ARRAY |
| Data type | UNSIGNED32 |
| Savable | yes, category: verify |
| Access | read only |
| PDO mapping | no |
| Allowed values | |
| Preset value | |
| Firmware version | FIR-v1540 |
| Change history | |

Value description

| | |
|----------------|-------------------|
| Subindex | 00 _h |
| Name | Number Of Entries |
| Data type | UNSIGNED8 |
| Access | read only |
| PDO mapping | no |
| Allowed values | |
| Preset value | 02 _h |

| | |
|----------------|-----------------------|
| Subindex | 01 _h |
| Name | Configuration Date |
| Data type | UNSIGNED32 |
| Access | read / write |
| PDO mapping | no |
| Allowed values | |
| Preset value | 00000000 _h |

| | |
|----------|-----------------|
| Subindex | 02 _h |
|----------|-----------------|

| | |
|----------------|-----------------------|
| Name | Configuration Time |
| Data type | UNSIGNED32 |
| Access | read / write |
| PDO mapping | no |
| Allowed values | |
| Preset value | 00000000 _h |

Description

Subindex 01_h (configuration date) is to contain the number of days since 1 January 1984.

Subindex 02_h (configuration time) is to contain the number of milliseconds since midnight.

1029h Error Behavior

Function

This object is used to define what the *NMT state* of the controller should be in case of an error. See also chapter [Network Management \(NMT\)](#).

Object description

| | |
|------------------|------------------------------|
| Index | 1029 _h |
| Object name | Error Behavior |
| Object Code | ARRAY |
| Data type | UNSIGNED8 |
| Savable | yes, category: communication |
| Access | read only |
| PDO mapping | no |
| Allowed values | |
| Preset value | |
| Firmware version | FIR-v1738-B501312 |
| Change history | |

Value description

| | |
|----------------|-------------------|
| Subindex | 00 _h |
| Name | Number Of Entries |
| Data type | UNSIGNED8 |
| Access | read only |
| PDO mapping | no |
| Allowed values | |
| Preset value | 02 _h |

| | |
|-----------|---------------------|
| Subindex | 01 _h |
| Name | Communication Error |
| Data type | UNSIGNED8 |
| Access | read / write |

| | |
|----------------|-----------------|
| PDO mapping | no |
| Allowed values | |
| Preset value | 00 _h |

| | |
|----------------|-----------------------|
| Subindex | 02 _h |
| Name | Internal Device Error |
| Data type | UNSIGNED8 |
| Access | read / write |
| PDO mapping | no |
| Allowed values | |
| Preset value | 01 _h |

Description

The subindices have the following function:

- 01_h: This subindex is used to define how to respond in case of a communication error:
 - Value "00"_h: The controller switches to the *Pre-Operational* state (if previously in the *Operational* state).
 - Value "01"_h: The controller does not change state.
 - Value "02"_h: The controller switches to the *Stopped* state.
- 02_h: This subindex is used to define how to respond to the remaining errors (except for communication errors):
 - Value "00"_h: The controller switches to the *Pre-Operational* state (if previously in the *Operational* state).
 - Value "01"_h: The controller does not change state.
 - Value "02"_h: The controller switches to the *Stopped* state.

1400h Receive PDO 1 Communication Parameter

Function

Contains the communication parameters for the receiving-side mapping (RX-PDO) in object 1600_h. See chapter [Process Data Object \(PDO\)](#).

Object description

| | |
|------------------|---------------------------------------|
| Index | 1400 _h |
| Object name | Receive PDO 1 Communication Parameter |
| Object Code | RECORD |
| Data type | PDO_COMMUNICATION_PARAMETER |
| Savable | yes, category: communication |
| Firmware version | FIR-v1426 |
| Change history | |

Value description

| | |
|----------|-------------------|
| Subindex | 00 _h |
| Name | Number Of Entries |

| | |
|----------------|-----------------|
| Data type | UNSIGNED8 |
| Access | read only |
| PDO mapping | no |
| Allowed values | |
| Preset value | 02 _h |

| | |
|----------------|-----------------------|
| Subindex | 01 _h |
| Name | COB-ID |
| Data type | UNSIGNED32 |
| Access | read / write |
| PDO mapping | no |
| Allowed values | |
| Preset value | 00000000 _h |

| | |
|----------------|-------------------|
| Subindex | 02 _h |
| Name | Transmission Type |
| Data type | UNSIGNED8 |
| Access | read / write |
| PDO mapping | no |
| Allowed values | |
| Preset value | FF _h |

Description

Subindex 01_h (COB-ID): The COB-ID is stored here.

Subindex 02_h (transmission type): A number is stored in this subindex that defines the time at which the received data become valid.

For details see chapter on [configuring the RX-PDO mapping](#).

1401h Receive PDO 2 Communication Parameter

Function

Contains the communication parameters for the receiving-side mapping (RX-PDO) in object 1601_h. See chapter [Process Data Object \(PDO\)](#).

Object description

| | |
|------------------|---------------------------------------|
| Index | 1401 _h |
| Object name | Receive PDO 2 Communication Parameter |
| Object Code | RECORD |
| Data type | PDO_COMMUNICATION_PARAMETER |
| Savable | yes, category: communication |
| Firmware version | FIR-v1426 |
| Change history | |

Value description

| | |
|----------------|-------------------|
| Subindex | 00 _h |
| Name | Number Of Entries |
| Data type | UNSIGNED8 |
| Access | read only |
| PDO mapping | no |
| Allowed values | |
| Preset value | 02 _h |

| | |
|----------------|-----------------------|
| Subindex | 01 _h |
| Name | COB-ID |
| Data type | UNSIGNED32 |
| Access | read / write |
| PDO mapping | no |
| Allowed values | |
| Preset value | 00000000 _h |

| | |
|----------------|-------------------|
| Subindex | 02 _h |
| Name | Transmission Type |
| Data type | UNSIGNED8 |
| Access | read / write |
| PDO mapping | no |
| Allowed values | |
| Preset value | FF _h |

Description

Subindex 01_h (COB-ID): The COB-ID is stored here.

Subindex 02_h (transmission type): A number is stored in this subindex that defines the time at which the received data become valid.

For details see chapter on [configuring the RX-PDO mapping](#).

1402h Receive PDO 3 Communication Parameter

Function

Contains the communication parameters for the receiving-side mapping (RX-PDO) in object 1602_h. See chapter [Process Data Object \(PDO\)](#).

Object description

| | |
|-------------|---------------------------------------|
| Index | 1402 _h |
| Object name | Receive PDO 3 Communication Parameter |
| Object Code | RECORD |
| Data type | PDO_COMMUNICATION_PARAMETER |
| Savable | yes, category: communication |

| | |
|------------------|-----------|
| Firmware version | FIR-v1426 |
| Change history | |

Value description

| | |
|----------------|-------------------|
| Subindex | 00 _h |
| Name | Number Of Entries |
| Data type | UNSIGNED8 |
| Access | read only |
| PDO mapping | no |
| Allowed values | |
| Preset value | 02 _h |

| | |
|----------------|-----------------------|
| Subindex | 01 _h |
| Name | COB-ID |
| Data type | UNSIGNED32 |
| Access | read / write |
| PDO mapping | no |
| Allowed values | |
| Preset value | 00000000 _h |

| | |
|----------------|-------------------|
| Subindex | 02 _h |
| Name | Transmission Type |
| Data type | UNSIGNED8 |
| Access | read / write |
| PDO mapping | no |
| Allowed values | |
| Preset value | FF _h |

Description

Subindex 01_h (COB-ID): The COB-ID is stored here.

Subindex 02_h (transmission type): A number is stored in this subindex that defines the time at which the received data become valid.

For details see chapter on [configuring the RX-PDO mapping](#).

1403h Receive PDO 4 Communication Parameter

Function

Contains the communication parameters for the receiving-side mapping (RX-PDO) in object 1603_h. See chapter [Process Data Object \(PDO\)](#).

Object description

| | |
|-------------|---------------------------------------|
| Index | 1403 _h |
| Object name | Receive PDO 4 Communication Parameter |

| | |
|------------------|------------------------------|
| Object Code | RECORD |
| Data type | PDO_COMMUNICATION_PARAMETER |
| Savable | yes, category: communication |
| Firmware version | FIR-v1426 |
| Change history | |

Value description

| | |
|----------------|-------------------|
| Subindex | 00 _h |
| Name | Number Of Entries |
| Data type | UNSIGNED8 |
| Access | read only |
| PDO mapping | no |
| Allowed values | |
| Preset value | 02 _h |

| | |
|----------------|-----------------------|
| Subindex | 01 _h |
| Name | COB-ID |
| Data type | UNSIGNED32 |
| Access | read / write |
| PDO mapping | no |
| Allowed values | |
| Preset value | 00000000 _h |

| | |
|----------------|-------------------|
| Subindex | 02 _h |
| Name | Transmission Type |
| Data type | UNSIGNED8 |
| Access | read / write |
| PDO mapping | no |
| Allowed values | |
| Preset value | FF _h |

Description

Subindex 01_h (COB-ID): The COB-ID is stored here.

Subindex 02_h (transmission type): A number is stored in this subindex that defines the time at which the received data become valid.

For details see chapter on [configuring the RX-PDO mapping](#).

1404h Receive PDO 5 Communication Parameter

Function

Contains the communication parameters for the receiving-side mapping (RX-PDO) in object 1604_h. See chapter [Process Data Object \(PDO\)](#).

Object description

| | |
|------------------|---------------------------------------|
| Index | 1404 _h |
| Object name | Receive PDO 5 Communication Parameter |
| Object Code | RECORD |
| Data type | PDO_COMMUNICATION_PARAMETER |
| Savable | yes, category: communication |
| Access | read only |
| PDO mapping | no |
| Allowed values | |
| Preset value | |
| Firmware version | FIR-v1614 |
| Change history | |

Value description

| | |
|----------------|-------------------|
| Subindex | 00 _h |
| Name | Number Of Entries |
| Data type | UNSIGNED8 |
| Access | read only |
| PDO mapping | no |
| Allowed values | |
| Preset value | 02 _h |

| | |
|----------------|-----------------------|
| Subindex | 01 _h |
| Name | COB-ID |
| Data type | UNSIGNED32 |
| Access | read / write |
| PDO mapping | no |
| Allowed values | |
| Preset value | 80000000 _h |

| | |
|----------------|-------------------|
| Subindex | 02 _h |
| Name | Transmission Type |
| Data type | UNSIGNED8 |
| Access | read / write |
| PDO mapping | no |
| Allowed values | |
| Preset value | FF _h |

Description

Subindex 01_h (COB-ID): The COB-ID is stored here.

Subindex 02_h (transmission type): A number is stored in this subindex that defines the time at which the received data become valid.

For details see chapter on [configuring the RX-PDO mapping](#).

1405h Receive PDO 6 Communication Parameter

Function

Contains the communication parameters for the receiving-side mapping (RX-PDO) in object 1605_h. See chapter [Process Data Object \(PDO\)](#).

Object description

| | |
|------------------|---------------------------------------|
| Index | 1405 _h |
| Object name | Receive PDO 6 Communication Parameter |
| Object Code | RECORD |
| Data type | PDO_COMMUNICATION_PARAMETER |
| Savable | yes, category: communication |
| Access | read only |
| PDO mapping | no |
| Allowed values | |
| Preset value | |
| Firmware version | FIR-v1614 |
| Change history | |

Value description

| | |
|----------------|-------------------|
| Subindex | 00 _h |
| Name | Number Of Entries |
| Data type | UNSIGNED8 |
| Access | read only |
| PDO mapping | no |
| Allowed values | |
| Preset value | 02 _h |

| | |
|----------------|-----------------------|
| Subindex | 01 _h |
| Name | COB-ID |
| Data type | UNSIGNED32 |
| Access | read / write |
| PDO mapping | no |
| Allowed values | |
| Preset value | 80000000 _h |

| | |
|----------------|-------------------|
| Subindex | 02 _h |
| Name | Transmission Type |
| Data type | UNSIGNED8 |
| Access | read / write |
| PDO mapping | no |
| Allowed values | |

| | |
|--------------|-----------------|
| Preset value | FF _h |
|--------------|-----------------|

Description

Subindex 01_h (COB-ID): The COB-ID is stored here.

Subindex 02_h (transmission type): A number is stored in this subindex that defines the time at which the received data become valid.

For details see chapter on [configuring the RX-PDO mapping](#).

1406h Receive PDO 7 Communication Parameter

Function

Contains the communication parameters for the receiving-side mapping (RX-PDO) in object 1606_h. See chapter [Process Data Object \(PDO\)](#).

Object description

| | |
|------------------|---------------------------------------|
| Index | 1406 _h |
| Object name | Receive PDO 7 Communication Parameter |
| Object Code | RECORD |
| Data type | PDO_COMMUNICATION_PARAMETER |
| Savable | yes, category: communication |
| Access | read only |
| PDO mapping | no |
| Allowed values | |
| Preset value | |
| Firmware version | FIR-v1614 |
| Change history | |

Value description

| | |
|----------------|-------------------|
| Subindex | 00 _h |
| Name | Number Of Entries |
| Data type | UNSIGNED8 |
| Access | read only |
| PDO mapping | no |
| Allowed values | |
| Preset value | 02 _h |

| | |
|----------------|-----------------------|
| Subindex | 01 _h |
| Name | COB-ID |
| Data type | UNSIGNED32 |
| Access | read / write |
| PDO mapping | no |
| Allowed values | |
| Preset value | 80000000 _h |

| | |
|----------------|-------------------|
| Subindex | 02 _h |
| Name | Transmission Type |
| Data type | UNSIGNED8 |
| Access | read / write |
| PDO mapping | no |
| Allowed values | |
| Preset value | FF _h |

Description

Subindex 01_h (COB-ID): The COB-ID is stored here.

Subindex 02_h (transmission type): A number is stored in this subindex that defines the time at which the received data become valid.

For details see chapter on [configuring the RX-PDO mapping](#).

1407h Receive PDO 8 Communication Parameter

Function

Contains the communication parameters for the receiving-side mapping (RX-PDO) in object 1607_h. See chapter [Process Data Object \(PDO\)](#).

Object description

| | |
|------------------|---------------------------------------|
| Index | 1407 _h |
| Object name | Receive PDO 8 Communication Parameter |
| Object Code | RECORD |
| Data type | PDO_COMMUNICATION_PARAMETER |
| Savable | yes, category: communication |
| Access | read only |
| PDO mapping | no |
| Allowed values | |
| Preset value | |
| Firmware version | FIR-v1614 |
| Change history | |

Value description

| | |
|----------------|-------------------|
| Subindex | 00 _h |
| Name | Number Of Entries |
| Data type | UNSIGNED8 |
| Access | read only |
| PDO mapping | no |
| Allowed values | |
| Preset value | 02 _h |

| | |
|----------|-----------------|
| Subindex | 01 _h |
|----------|-----------------|

| | |
|----------------|-----------------------|
| Name | COB-ID |
| Data type | UNSIGNED32 |
| Access | read / write |
| PDO mapping | no |
| Allowed values | |
| Preset value | 80000000 _h |

| | |
|----------------|-------------------|
| Subindex | 02 _h |
| Name | Transmission Type |
| Data type | UNSIGNED8 |
| Access | read / write |
| PDO mapping | no |
| Allowed values | |
| Preset value | FF _h |

Description

Subindex 01_h (COB-ID): The COB-ID is stored here.

Subindex 02_h (transmission type): A number is stored in this subindex that defines the time at which the received data become valid.

For details see chapter on [configuring the RX-PDO mapping](#).

1600h Receive PDO 1 Mapping Parameter

Function

This object contains the mapping parameters for PDOs that the controller can receive (RX-PDO 1).

Object description

| | |
|------------------|--|
| Index | 1600 _h |
| Object name | Receive PDO 1 Mapping Parameter |
| Object Code | RECORD |
| Data type | PDO_MAPPING |
| Savable | yes, category: communication |
| Firmware version | FIR-v1426 |
| Change history | Firmware version FIR-v1426: "Heading" entry changed from "1600h Drive Control" to "1600h Receive PDO 1 Mapping Parameter". Firmware version FIR-v1426: "Object Name" entry changed from "Drive Control" to "Receive PDO 1 Mapping Parameter". |

Value description

| | |
|-----------|-------------------|
| Subindex | 00 _h |
| Name | Number Of Entries |
| Data type | UNSIGNED8 |
| Access | read / write |

| | |
|----------------|-------------------------|
| PDO mapping | no |
| Allowed values | |
| Preset value | 02 _h |
| <hr/> | |
| Subindex | 01 _h |
| Name | 1st Object To Be Mapped |
| Data type | UNSIGNED32 |
| Access | read / write |
| PDO mapping | no |
| Allowed values | |
| Preset value | 60400010 _h |
| <hr/> | |
| Subindex | 02 _h |
| Name | 2nd Object To Be Mapped |
| Data type | UNSIGNED32 |
| Access | read / write |
| PDO mapping | no |
| Allowed values | |
| Preset value | 60600008 _h |
| <hr/> | |
| Subindex | 03 _h |
| Name | 3rd Object To Be Mapped |
| Data type | UNSIGNED32 |
| Access | read / write |
| PDO mapping | no |
| Allowed values | |
| Preset value | 00000000 _h |
| <hr/> | |
| Subindex | 04 _h |
| Name | 4th Object To Be Mapped |
| Data type | UNSIGNED32 |
| Access | read / write |
| PDO mapping | no |
| Allowed values | |
| Preset value | 00000000 _h |
| <hr/> | |
| Subindex | 05 _h |
| Name | 5th Object To Be Mapped |
| Data type | UNSIGNED32 |
| Access | read / write |
| PDO mapping | no |
| Allowed values | |
| Preset value | 00000000 _h |

| | |
|----------------|-------------------------|
| Subindex | 06 _h |
| Name | 6th Object To Be Mapped |
| Data type | UNSIGNED32 |
| Access | read / write |
| PDO mapping | no |
| Allowed values | |
| Preset value | 00000000 _h |

| | |
|----------------|-------------------------|
| Subindex | 07 _h |
| Name | 7th Object To Be Mapped |
| Data type | UNSIGNED32 |
| Access | read / write |
| PDO mapping | no |
| Allowed values | |
| Preset value | 00000000 _h |

| | |
|----------------|-------------------------|
| Subindex | 08 _h |
| Name | 8th Object To Be Mapped |
| Data type | UNSIGNED32 |
| Access | read / write |
| PDO mapping | no |
| Allowed values | |
| Preset value | 00000000 _h |

Description

Each subindex (1–8) describes a different mapped object.

A mapping entry consists of four bytes, which are structured according to the following graphic.

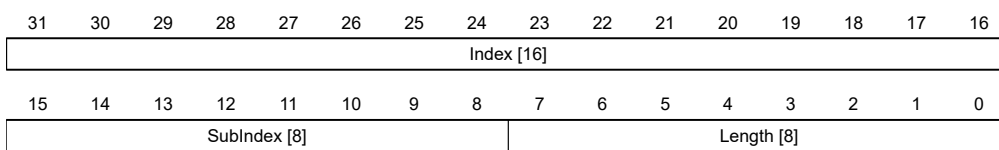

Index [16]

This contains the index of the object to be mapped.

Subindex [8]

This contains the subindex of the object to be mapped.

Length [8]

This contains the length of the object to be mapped in units of bits.

1601h Receive PDO 2 Mapping Parameter

Function

This object contains the mapping parameters for PDOs that the controller can receive (RX-PDO 2).

Object description

| | |
|------------------|---|
| Index | 1601 _h |
| Object name | Receive PDO 2 Mapping Parameter |
| Object Code | RECORD |
| Data type | PDO_MAPPING |
| Savable | yes, category: communication |
| Firmware version | FIR-v1426 |
| Change history | <p>Firmware version FIR-v1426: "Heading" entry changed from "1601h Positioning Control" to "1601h Receive PDO 2 Mapping Parameter".</p> <p>Firmware version FIR-v1426: "Object Name" entry changed from "Positioning Control" to "Receive PDO 2 Mapping Parameter".</p> |

Value description

| | |
|----------------|-------------------------|
| Subindex | 00 _h |
| Name | Number Of Entries |
| Data type | UNSIGNED8 |
| Access | read / write |
| PDO mapping | no |
| Allowed values | |
| Preset value | 02 _h |
| Subindex | 01 _h |
| Name | 1st Object To Be Mapped |
| Data type | UNSIGNED32 |
| Access | read / write |
| PDO mapping | no |
| Allowed values | |
| Preset value | 607A0020 _h |
| Subindex | 02 _h |
| Name | 2nd Object To Be Mapped |
| Data type | UNSIGNED32 |
| Access | read / write |
| PDO mapping | no |
| Allowed values | |
| Preset value | 60810020 _h |
| Subindex | 03 _h |
| Name | 3rd Object To Be Mapped |
| Data type | UNSIGNED32 |
| Access | read / write |
| PDO mapping | no |

| | |
|----------------|-------------------------|
| Allowed values | |
| Preset value | 00000000 _h |
| <hr/> | |
| Subindex | 04 _h |
| Name | 4th Object To Be Mapped |
| Data type | UNSIGNED32 |
| Access | read / write |
| PDO mapping | no |
| Allowed values | |
| Preset value | 00000000 _h |
| <hr/> | |
| Subindex | 05 _h |
| Name | 5th Object To Be Mapped |
| Data type | UNSIGNED32 |
| Access | read / write |
| PDO mapping | no |
| Allowed values | |
| Preset value | 00000000 _h |
| <hr/> | |
| Subindex | 06 _h |
| Name | 6th Object To Be Mapped |
| Data type | UNSIGNED32 |
| Access | read / write |
| PDO mapping | no |
| Allowed values | |
| Preset value | 00000000 _h |
| <hr/> | |
| Subindex | 07 _h |
| Name | 7th Object To Be Mapped |
| Data type | UNSIGNED32 |
| Access | read / write |
| PDO mapping | no |
| Allowed values | |
| Preset value | 00000000 _h |
| <hr/> | |
| Subindex | 08 _h |
| Name | 8th Object To Be Mapped |
| Data type | UNSIGNED32 |
| Access | read / write |
| PDO mapping | no |
| Allowed values | |
| Preset value | 00000000 _h |

Description

Each subindex (1–8) describes a different mapped object.

A mapping entry consists of four bytes, which are structured according to the following graphic.

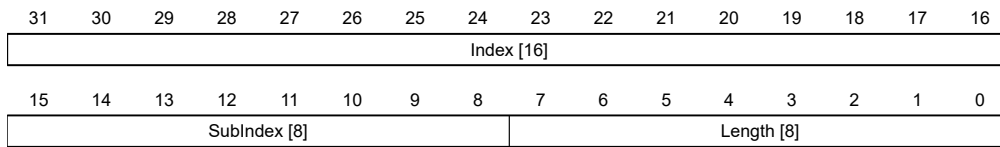

Index [16]

This contains the index of the object to be mapped.

Subindex [8]

This contains the subindex of the object to be mapped.

Length [8]

This contains the length of the object to be mapped in units of bits.

1602h Receive PDO 3 Mapping Parameter

Function

This object contains the mapping parameters for PDOs that the controller can receive (RX-PDO 3).

Object description

| | |
|------------------|---|
| Index | 1602 _h |
| Object name | Receive PDO 3 Mapping Parameter |
| Object Code | RECORD |
| Data type | PDO_MAPPING |
| Savable | yes, category: communication |
| Firmware version | FIR-v1426 |
| Change history | <p>Firmware version FIR-v1426: "Heading" entry changed from "1602h Velocity Control" to "1602h Receive PDO 3 Mapping Parameter".</p> <p>Firmware version FIR-v1426: "Object Name" entry changed from "Velocity Control" to "Receive PDO 3 Mapping Parameter".</p> |

Value description

| | |
|----------------|-------------------|
| Subindex | 00 _h |
| Name | Number Of Entries |
| Data type | UNSIGNED8 |
| Access | read / write |
| PDO mapping | no |
| Allowed values | |
| Preset value | 01 _h |
| | |
| Subindex | 01 _h |

| | |
|----------------|-------------------------|
| Name | 1st Object To Be Mapped |
| Data type | UNSIGNED32 |
| Access | read / write |
| PDO mapping | no |
| Allowed values | |
| Preset value | 60420010 _h |

| | |
|----------------|-------------------------|
| Subindex | 02 _h |
| Name | 2nd Object To Be Mapped |
| Data type | UNSIGNED32 |
| Access | read / write |
| PDO mapping | no |
| Allowed values | |
| Preset value | 00000000 _h |

| | |
|----------------|-------------------------|
| Subindex | 03 _h |
| Name | 3rd Object To Be Mapped |
| Data type | UNSIGNED32 |
| Access | read / write |
| PDO mapping | no |
| Allowed values | |
| Preset value | 00000000 _h |

| | |
|----------------|-------------------------|
| Subindex | 04 _h |
| Name | 4th Object To Be Mapped |
| Data type | UNSIGNED32 |
| Access | read / write |
| PDO mapping | no |
| Allowed values | |
| Preset value | 00000000 _h |

| | |
|----------------|-------------------------|
| Subindex | 05 _h |
| Name | 5th Object To Be Mapped |
| Data type | UNSIGNED32 |
| Access | read / write |
| PDO mapping | no |
| Allowed values | |
| Preset value | 00000000 _h |

| | |
|-----------|-------------------------|
| Subindex | 06 _h |
| Name | 6th Object To Be Mapped |
| Data type | UNSIGNED32 |
| Access | read / write |

| | |
|----------------|-----------------------|
| PDO mapping | no |
| Allowed values | |
| Preset value | 00000000 _h |

| | |
|----------------|-------------------------|
| Subindex | 07 _h |
| Name | 7th Object To Be Mapped |
| Data type | UNSIGNED32 |
| Access | read / write |
| PDO mapping | no |
| Allowed values | |
| Preset value | 00000000 _h |

| | |
|----------------|-------------------------|
| Subindex | 08 _h |
| Name | 8th Object To Be Mapped |
| Data type | UNSIGNED32 |
| Access | read / write |
| PDO mapping | no |
| Allowed values | |
| Preset value | 00000000 _h |

1603h Receive PDO 4 Mapping Parameter

Function

This object contains the mapping parameters for PDOs that the controller can receive (RX-PDO 4).

Object description

| | |
|------------------|--|
| Index | 1603 _h |
| Object name | Receive PDO 4 Mapping Parameter |
| Object Code | RECORD |
| Data type | PDO_MAPPING |
| Savable | yes, category: communication |
| Firmware version | FIR-v1426 |
| Change history | Firmware version FIR-v1426: "Heading" entry changed from "1603h Output Control" to "1603h Receive PDO 4 Mapping Parameter". Firmware version FIR-v1426: "Object Name" entry changed from "Output Control" to "Receive PDO 4 Mapping Parameter". |

Value description

| | |
|-----------|-------------------|
| Subindex | 00 _h |
| Name | Number Of Entries |
| Data type | UNSIGNED8 |
| Access | read / write |

| | |
|----------------|-------------------------|
| PDO mapping | no |
| Allowed values | |
| Preset value | 01 _h |
| <hr/> | |
| Subindex | 01 _h |
| Name | 1st Object To Be Mapped |
| Data type | UNSIGNED32 |
| Access | read / write |
| PDO mapping | no |
| Allowed values | |
| Preset value | 60FE0120 _h |
| <hr/> | |
| Subindex | 02 _h |
| Name | 2nd Object To Be Mapped |
| Data type | UNSIGNED32 |
| Access | read / write |
| PDO mapping | no |
| Allowed values | |
| Preset value | 00000000 _h |
| <hr/> | |
| Subindex | 03 _h |
| Name | 3rd Object To Be Mapped |
| Data type | UNSIGNED32 |
| Access | read / write |
| PDO mapping | no |
| Allowed values | |
| Preset value | 00000000 _h |
| <hr/> | |
| Subindex | 04 _h |
| Name | 4th Object To Be Mapped |
| Data type | UNSIGNED32 |
| Access | read / write |
| PDO mapping | no |
| Allowed values | |
| Preset value | 00000000 _h |
| <hr/> | |
| Subindex | 05 _h |
| Name | 5th Object To Be Mapped |
| Data type | UNSIGNED32 |
| Access | read / write |
| PDO mapping | no |
| Allowed values | |
| Preset value | 00000000 _h |

| | |
|----------------|-------------------------|
| Subindex | 06 _h |
| Name | 6th Object To Be Mapped |
| Data type | UNSIGNED32 |
| Access | read / write |
| PDO mapping | no |
| Allowed values | |
| Preset value | 00000000 _h |

| | |
|----------------|-------------------------|
| Subindex | 07 _h |
| Name | 7th Object To Be Mapped |
| Data type | UNSIGNED32 |
| Access | read / write |
| PDO mapping | no |
| Allowed values | |
| Preset value | 00000000 _h |

| | |
|----------------|-------------------------|
| Subindex | 08 _h |
| Name | 8th Object To Be Mapped |
| Data type | UNSIGNED32 |
| Access | read / write |
| PDO mapping | no |
| Allowed values | |
| Preset value | 00000000 _h |

1604h Receive PDO 5 Mapping Parameter

Function

This object contains the mapping parameters for PDOs that the controller can receive (RX-PDO 5). The PDO was previously configured via [1404h Receive PDO 5 Communication Parameter](#). See chapter [Process Data Object \(PDO\)](#).

Object description

| | |
|------------------|---------------------------------|
| Index | 1604 _h |
| Object name | Receive PDO 5 Mapping Parameter |
| Object Code | RECORD |
| Data type | PDO_MAPPING |
| Savable | yes, category: communication |
| Access | read / write |
| PDO mapping | no |
| Allowed values | |
| Preset value | |
| Firmware version | FIR-v1614 |
| Change history | |

Value description

| | |
|----------------|-------------------|
| Subindex | 00 _h |
| Name | Number Of Entries |
| Data type | UNSIGNED8 |
| Access | read / write |
| PDO mapping | no |
| Allowed values | |
| Preset value | 00 _h |

| | |
|----------------|-------------------------|
| Subindex | 01 _h |
| Name | 1st Object To Be Mapped |
| Data type | UNSIGNED32 |
| Access | read / write |
| PDO mapping | no |
| Allowed values | |
| Preset value | 00000000 _h |

| | |
|----------------|-------------------------|
| Subindex | 02 _h |
| Name | 2nd Object To Be Mapped |
| Data type | UNSIGNED32 |
| Access | read / write |
| PDO mapping | no |
| Allowed values | |
| Preset value | 00000000 _h |

| | |
|----------------|-------------------------|
| Subindex | 03 _h |
| Name | 3rd Object To Be Mapped |
| Data type | UNSIGNED32 |
| Access | read / write |
| PDO mapping | no |
| Allowed values | |
| Preset value | 00000000 _h |

| | |
|----------------|-------------------------|
| Subindex | 04 _h |
| Name | 4th Object To Be Mapped |
| Data type | UNSIGNED32 |
| Access | read / write |
| PDO mapping | no |
| Allowed values | |
| Preset value | 00000000 _h |

| | |
|----------|-----------------|
| Subindex | 05 _h |
|----------|-----------------|

| | |
|----------------|-------------------------|
| Name | 5th Object To Be Mapped |
| Data type | UNSIGNED32 |
| Access | read / write |
| PDO mapping | no |
| Allowed values | |
| Preset value | 00000000 _h |

| | |
|----------------|-------------------------|
| Subindex | 06 _h |
| Name | 6th Object To Be Mapped |
| Data type | UNSIGNED32 |
| Access | read / write |
| PDO mapping | no |
| Allowed values | |
| Preset value | 00000000 _h |

| | |
|----------------|-------------------------|
| Subindex | 07 _h |
| Name | 7th Object To Be Mapped |
| Data type | UNSIGNED32 |
| Access | read / write |
| PDO mapping | no |
| Allowed values | |
| Preset value | 00000000 _h |

| | |
|----------------|-------------------------|
| Subindex | 08 _h |
| Name | 8th Object To Be Mapped |
| Data type | UNSIGNED32 |
| Access | read / write |
| PDO mapping | no |
| Allowed values | |
| Preset value | 00000000 _h |

1605h Receive PDO 6 Mapping Parameter

Function

This object contains the mapping parameters for PDOs that the controller can receive (RX-PDO 6). The PDO was previously configured via [1405h Receive PDO 6 Communication Parameter](#). See chapter [Process Data Object \(PDO\)](#).

Object description

| | |
|-------------|---------------------------------|
| Index | 1605 _h |
| Object name | Receive PDO 6 Mapping Parameter |
| Object Code | RECORD |
| Data type | PDO_MAPPING |
| Savable | yes, category: communication |

| | |
|------------------|--------------|
| Access | read / write |
| PDO mapping | no |
| Allowed values | |
| Preset value | |
| Firmware version | FIR-v1614 |
| Change history | |

Value description

| | |
|----------------|-------------------|
| Subindex | 00 _h |
| Name | Number Of Entries |
| Data type | UNSIGNED8 |
| Access | read / write |
| PDO mapping | no |
| Allowed values | |
| Preset value | 00 _h |

| | |
|----------------|-------------------------|
| Subindex | 01 _h |
| Name | 1st Object To Be Mapped |
| Data type | UNSIGNED32 |
| Access | read / write |
| PDO mapping | no |
| Allowed values | |
| Preset value | 00000000 _h |

| | |
|----------------|-------------------------|
| Subindex | 02 _h |
| Name | 2nd Object To Be Mapped |
| Data type | UNSIGNED32 |
| Access | read / write |
| PDO mapping | no |
| Allowed values | |
| Preset value | 00000000 _h |

| | |
|----------------|-------------------------|
| Subindex | 03 _h |
| Name | 3rd Object To Be Mapped |
| Data type | UNSIGNED32 |
| Access | read / write |
| PDO mapping | no |
| Allowed values | |
| Preset value | 00000000 _h |

| | |
|----------|-------------------------|
| Subindex | 04 _h |
| Name | 4th Object To Be Mapped |

| | |
|----------------|-----------------------|
| Data type | UNSIGNED32 |
| Access | read / write |
| PDO mapping | no |
| Allowed values | |
| Preset value | 00000000 _h |

| | |
|----------------|-------------------------|
| Subindex | 05 _h |
| Name | 5th Object To Be Mapped |
| Data type | UNSIGNED32 |
| Access | read / write |
| PDO mapping | no |
| Allowed values | |
| Preset value | 00000000 _h |

| | |
|----------------|-------------------------|
| Subindex | 06 _h |
| Name | 6th Object To Be Mapped |
| Data type | UNSIGNED32 |
| Access | read / write |
| PDO mapping | no |
| Allowed values | |
| Preset value | 00000000 _h |

| | |
|----------------|-------------------------|
| Subindex | 07 _h |
| Name | 7th Object To Be Mapped |
| Data type | UNSIGNED32 |
| Access | read / write |
| PDO mapping | no |
| Allowed values | |
| Preset value | 00000000 _h |

| | |
|----------------|-------------------------|
| Subindex | 08 _h |
| Name | 8th Object To Be Mapped |
| Data type | UNSIGNED32 |
| Access | read / write |
| PDO mapping | no |
| Allowed values | |
| Preset value | 00000000 _h |

1606h Receive PDO 7 Mapping Parameter

Function

This object contains the mapping parameters for PDOs that the controller can receive (RX-PDO 7). The PDO was previously configured via [1406h Receive PDO 7 Communication Parameter](#). See chapter [Process Data Object \(PDO\)](#).

Object description

| | |
|------------------|---------------------------------|
| Index | 1606 _h |
| Object name | Receive PDO 7 Mapping Parameter |
| Object Code | RECORD |
| Data type | PDO_MAPPING |
| Savable | yes, category: communication |
| Access | read / write |
| PDO mapping | no |
| Allowed values | |
| Preset value | |
| Firmware version | FIR-v1614 |
| Change history | |

Value description

| | |
|----------------|-------------------|
| Subindex | 00 _h |
| Name | Number Of Entries |
| Data type | UNSIGNED8 |
| Access | read / write |
| PDO mapping | no |
| Allowed values | |
| Preset value | 00 _h |

| | |
|----------------|-------------------------|
| Subindex | 01 _h |
| Name | 1st Object To Be Mapped |
| Data type | UNSIGNED32 |
| Access | read / write |
| PDO mapping | no |
| Allowed values | |
| Preset value | 00000000 _h |

| | |
|----------------|-------------------------|
| Subindex | 02 _h |
| Name | 2nd Object To Be Mapped |
| Data type | UNSIGNED32 |
| Access | read / write |
| PDO mapping | no |
| Allowed values | |
| Preset value | 00000000 _h |

| | |
|-----------|-------------------------|
| Subindex | 03 _h |
| Name | 3rd Object To Be Mapped |
| Data type | UNSIGNED32 |
| Access | read / write |

| | |
|----------------|-------------------------|
| PDO mapping | no |
| Allowed values | |
| Preset value | 00000000 _h |
| <hr/> | |
| Subindex | 04 _h |
| Name | 4th Object To Be Mapped |
| Data type | UNSIGNED32 |
| Access | read / write |
| PDO mapping | no |
| Allowed values | |
| Preset value | 00000000 _h |
| <hr/> | |
| Subindex | 05 _h |
| Name | 5th Object To Be Mapped |
| Data type | UNSIGNED32 |
| Access | read / write |
| PDO mapping | no |
| Allowed values | |
| Preset value | 00000000 _h |
| <hr/> | |
| Subindex | 06 _h |
| Name | 6th Object To Be Mapped |
| Data type | UNSIGNED32 |
| Access | read / write |
| PDO mapping | no |
| Allowed values | |
| Preset value | 00000000 _h |
| <hr/> | |
| Subindex | 07 _h |
| Name | 7th Object To Be Mapped |
| Data type | UNSIGNED32 |
| Access | read / write |
| PDO mapping | no |
| Allowed values | |
| Preset value | 00000000 _h |
| <hr/> | |
| Subindex | 08 _h |
| Name | 8th Object To Be Mapped |
| Data type | UNSIGNED32 |
| Access | read / write |
| PDO mapping | no |
| Allowed values | |
| Preset value | 00000000 _h |

1607h Receive PDO 8 Mapping Parameter

Function

This object contains the mapping parameters for PDOs that the controller can receive (RX-PDO 8). The PDO was previously configured via [1407h Receive PDO 8 Communication Parameter](#). See chapter [Process Data Object \(PDO\)](#).

Object description

| | |
|------------------|---------------------------------|
| Index | 1607 _h |
| Object name | Receive PDO 8 Mapping Parameter |
| Object Code | RECORD |
| Data type | PDO_MAPPING |
| Savable | yes, category: communication |
| Access | read / write |
| PDO mapping | no |
| Allowed values | |
| Preset value | |
| Firmware version | FIR-v1614 |
| Change history | |

Value description

| | |
|----------------|-------------------|
| Subindex | 00 _h |
| Name | Number Of Entries |
| Data type | UNSIGNED8 |
| Access | read / write |
| PDO mapping | no |
| Allowed values | |
| Preset value | 00 _h |

| | |
|----------------|-------------------------|
| Subindex | 01 _h |
| Name | 1st Object To Be Mapped |
| Data type | UNSIGNED32 |
| Access | read / write |
| PDO mapping | no |
| Allowed values | |
| Preset value | 00000000 _h |

| | |
|----------------|-------------------------|
| Subindex | 02 _h |
| Name | 2nd Object To Be Mapped |
| Data type | UNSIGNED32 |
| Access | read / write |
| PDO mapping | no |
| Allowed values | |
| Preset value | 00000000 _h |

| | |
|----------------|-------------------------|
| Subindex | 03 _h |
| Name | 3rd Object To Be Mapped |
| Data type | UNSIGNED32 |
| Access | read / write |
| PDO mapping | no |
| Allowed values | |
| Preset value | 00000000 _h |

| | |
|----------------|-------------------------|
| Subindex | 04 _h |
| Name | 4th Object To Be Mapped |
| Data type | UNSIGNED32 |
| Access | read / write |
| PDO mapping | no |
| Allowed values | |
| Preset value | 00000000 _h |

| | |
|----------------|-------------------------|
| Subindex | 05 _h |
| Name | 5th Object To Be Mapped |
| Data type | UNSIGNED32 |
| Access | read / write |
| PDO mapping | no |
| Allowed values | |
| Preset value | 00000000 _h |

| | |
|----------------|-------------------------|
| Subindex | 06 _h |
| Name | 6th Object To Be Mapped |
| Data type | UNSIGNED32 |
| Access | read / write |
| PDO mapping | no |
| Allowed values | |
| Preset value | 00000000 _h |

| | |
|----------------|-------------------------|
| Subindex | 07 _h |
| Name | 7th Object To Be Mapped |
| Data type | UNSIGNED32 |
| Access | read / write |
| PDO mapping | no |
| Allowed values | |
| Preset value | 00000000 _h |

| | |
|-----------|-------------------------|
| Subindex | 08 _h |
| Name | 8th Object To Be Mapped |
| Data type | UNSIGNED32 |

| | |
|----------------|-----------------------|
| Access | read / write |
| PDO mapping | no |
| Allowed values | |
| Preset value | 00000000 _h |

1800h Transmit PDO 1 Communication Parameter

Function

Contains the communication parameters for the sending-side mapping (TX-PDO) 1. See chapter [Process Data Object \(PDO\)](#).

Object description

| | |
|------------------|--|
| Index | 1800 _h |
| Object name | Transmit PDO 1 Communication Parameter |
| Object Code | RECORD |
| Data type | PDO_COMMUNICATION_PARAMETER |
| Savable | yes, category: communication |
| Access | read only |
| PDO mapping | no |
| Allowed values | |
| Preset value | |
| Firmware version | FIR-v1426 |
| Change history | Firmware version FIR-v1738-B501312: The number of entries was changed from 6 to 7. |

Value description

| | |
|----------------|-------------------|
| Subindex | 00 _h |
| Name | Number Of Entries |
| Data type | UNSIGNED8 |
| Access | read only |
| PDO mapping | no |
| Allowed values | |
| Preset value | 06 _h |

| | |
|----------------|-----------------------|
| Subindex | 01 _h |
| Name | COB-ID |
| Data type | UNSIGNED32 |
| Access | read / write |
| PDO mapping | no |
| Allowed values | |
| Preset value | 00000000 _h |

| | |
|----------------|-------------------|
| Subindex | 02 _h |
| Name | Transmission Type |
| Data type | UNSIGNED8 |
| Access | read / write |
| PDO mapping | no |
| Allowed values | |
| Preset value | FF _h |

| | |
|----------------|-------------------|
| Subindex | 03 _h |
| Name | Inhibit Time |
| Data type | UNSIGNED16 |
| Access | read / write |
| PDO mapping | no |
| Allowed values | |
| Preset value | 0064 _h |

| | |
|----------------|---------------------|
| Subindex | 04 _h |
| Name | Compatibility Entry |
| Data type | UNSIGNED8 |
| Access | read / write |
| PDO mapping | no |
| Allowed values | |
| Preset value | 00 _h |

| | |
|----------------|-------------------|
| Subindex | 05 _h |
| Name | Event Timer |
| Data type | UNSIGNED16 |
| Access | read / write |
| PDO mapping | no |
| Allowed values | |
| Preset value | 0000 _h |

| | |
|----------------|------------------|
| Subindex | 06 _h |
| Name | SYNC Start Value |
| Data type | UNSIGNED8 |
| Access | read / write |
| PDO mapping | no |
| Allowed values | |
| Preset value | 00 _h |

Description

Subindex 01_h (COB-ID): The COB-ID is stored here.

Subindex 02_h (transmission type): A number is stored in this subindex that defines the time at which the received data become valid.

Subindex 3 (inhibit time): This can be used to set a time in 100 µs steps that must elapse after the sending of a PDO before the PDO is sent another time. This time only applies for asynchronous PDOs.

Subindex 4 (compatibility entry): This subindex has no function and exists only for compatibility reasons.

Subindex 5 (event timer): This time (in ms) can be used to trigger an *Event* which handles the copying of the data and the sending of the PDO.

Subindex 6 (sync start value): Here, the start value of the *Sync Counter* is entered beginning with which the *slave* is to initially respond to the sync and send the PDO. Thereafter, sending of the PDO is only dependent on *Transmission Type* (subindex 02_h). Not globally activated until a value greater than 1 is set in 1019h Synchronous Counter Overflow Value.

For details, see chapter on configuring the Tx-PDO mapping.

1801h Transmit PDO 2 Communication Parameter

Function

Contains the communication parameters for the sending-side mapping (TX-PDO) 2. See chapter Process Data Object (PDO).

Object description

| | |
|------------------|--|
| Index | 1801 _h |
| Object name | Transmit PDO 2 Communication Parameter |
| Object Code | RECORD |
| Data type | PDO_COMMUNICATION_PARAMETER |
| Savable | yes, category: communication |
| Access | read only |
| PDO mapping | no |
| Allowed values | |
| Preset value | |
| Firmware version | FIR-v1426 |
| Change history | Firmware version FIR-v1738-B501312: The number of entries was changed from 6 to 7. |

Value description

| | |
|----------------|-------------------|
| Subindex | 00 _h |
| Name | Number Of Entries |
| Data type | UNSIGNED8 |
| Access | read only |
| PDO mapping | no |
| Allowed values | |
| Preset value | 06 _h |

| | |
|----------|-----------------|
| Subindex | 01 _h |
| Name | COB-ID |

| | |
|----------------|-----------------------|
| Data type | UNSIGNED32 |
| Access | read / write |
| PDO mapping | no |
| Allowed values | |
| Preset value | 00000000 _h |

| | |
|----------------|-------------------|
| Subindex | 02 _h |
| Name | Transmission Type |
| Data type | UNSIGNED8 |
| Access | read / write |
| PDO mapping | no |
| Allowed values | |
| Preset value | FF _h |

| | |
|----------------|-------------------|
| Subindex | 03 _h |
| Name | Inhibit Time |
| Data type | UNSIGNED16 |
| Access | read / write |
| PDO mapping | no |
| Allowed values | |
| Preset value | 0064 _h |

| | |
|----------------|---------------------|
| Subindex | 04 _h |
| Name | Compatibility Entry |
| Data type | UNSIGNED8 |
| Access | read / write |
| PDO mapping | no |
| Allowed values | |
| Preset value | 00 _h |

| | |
|----------------|-------------------|
| Subindex | 05 _h |
| Name | Event Timer |
| Data type | UNSIGNED16 |
| Access | read / write |
| PDO mapping | no |
| Allowed values | |
| Preset value | 0000 _h |

| | |
|-------------|------------------|
| Subindex | 06 _h |
| Name | SYNC Start Value |
| Data type | UNSIGNED8 |
| Access | read / write |
| PDO mapping | no |

Allowed values

Preset value 00_h

Description

Subindex 01_h (COB-ID): The COB-ID is stored here.

Subindex 02_h (transmission type): A number is stored in this subindex that defines the time at which the received data become valid.

Subindex 3 (inhibit time): This can be used to set a time in 100 μs steps that must elapse after the sending of a PDO before the PDO is sent another time. This time only applies for asynchronous PDOs.

Subindex 4 (compatibility entry): This subindex has no function and exists only for compatibility reasons.

Subindex 5 (event timer): This time (in ms) can be used to trigger an *Event* which handles the copying of the data and the sending of the PDO.

Subindex 6 (sync start value): Here, the start value of the *Sync Counter* is entered beginning with which the *slave* is to initially respond to the sync and send the PDO. Thereafter, sending of the PDO is only dependent on *Transmission Type* (subindex 02_h). Not globally activated until a value greater than 1 is set in 1019h Synchronous Counter Overflow Value.

For details, see chapter on [configuring the Tx-PDO mapping](#).

1802h Transmit PDO 3 Communication Parameter

Function

Contains the communication parameters for the sending-side mapping (TX-PDO) 3. See chapter [Process Data Object \(PDO\)](#).

Object description

| | |
|------------------|--|
| Index | 1802 _h |
| Object name | Transmit PDO 3 Communication Parameter |
| Object Code | RECORD |
| Data type | PDO_COMMUNICATION_PARAMETER |
| Savable | yes, category: communication |
| Access | read only |
| PDO mapping | no |
| Allowed values | |
| Preset value | |
| Firmware version | FIR-v1426 |
| Change history | Firmware version FIR-v1738-B501312: The number of entries was changed from 6 to 7. |

Value description

| | |
|-------------|-------------------|
| Subindex | 00 _h |
| Name | Number Of Entries |
| Data type | UNSIGNED8 |
| Access | read only |
| PDO mapping | no |

| | |
|----------------|-----------------------|
| Allowed values | |
| Preset value | 06 _h |
| <hr/> | |
| Subindex | 01 _h |
| Name | COB-ID |
| Data type | UNSIGNED32 |
| Access | read / write |
| PDO mapping | no |
| Allowed values | |
| Preset value | 00000000 _h |
| <hr/> | |
| Subindex | 02 _h |
| Name | Transmission Type |
| Data type | UNSIGNED8 |
| Access | read / write |
| PDO mapping | no |
| Allowed values | |
| Preset value | FF _h |
| <hr/> | |
| Subindex | 03 _h |
| Name | Inhibit Time |
| Data type | UNSIGNED16 |
| Access | read / write |
| PDO mapping | no |
| Allowed values | |
| Preset value | 0064 _h |
| <hr/> | |
| Subindex | 04 _h |
| Name | Compatibility Entry |
| Data type | UNSIGNED8 |
| Access | read / write |
| PDO mapping | no |
| Allowed values | |
| Preset value | 00 _h |
| <hr/> | |
| Subindex | 05 _h |
| Name | Event Timer |
| Data type | UNSIGNED16 |
| Access | read / write |
| PDO mapping | no |
| Allowed values | |
| Preset value | 0000 _h |

| | |
|----------------|------------------|
| Subindex | 06 _h |
| Name | SYNC Start Value |
| Data type | UNSIGNED8 |
| Access | read / write |
| PDO mapping | no |
| Allowed values | |
| Preset value | 00 _h |

Description

Subindex 01_h (COB-ID): The COB-ID is stored here.

Subindex 02_h (transmission type): A number is stored in this subindex that defines the time at which the received data become valid.

Subindex 3 (inhibit time): This can be used to set a time in 100 µs steps that must elapse after the sending of a PDO before the PDO is sent another time. This time only applies for asynchronous PDOs.

Subindex 4 (compatibility entry): This subindex has no function and exists only for compatibility reasons.

Subindex 5 (event timer): This time (in ms) can be used to trigger an *Event* which handles the copying of the data and the sending of the PDO.

Subindex 6 (sync start value): Here, the start value of the *Sync Counter* is entered beginning with which the *slave* is to initially respond to the sync and send the PDO. Thereafter, sending of the PDO is only dependent on *Transmission Type* (subindex 02_h). Not globally activated until a value greater than 1 is set in 1019h Synchronous Counter Overflow Value.

For details, see chapter on [configuring the Tx-PDO mapping](#).

1803h Transmit PDO 4 Communication Parameter

Function

Contains the communication parameters for the sending-side mapping (TX-PDO) 4. See chapter [Process Data Object \(PDO\)](#).

Object description

| | |
|------------------|--|
| Index | 1803 _h |
| Object name | Transmit PDO 4 Communication Parameter |
| Object Code | RECORD |
| Data type | PDO_COMMUNICATION_PARAMETER |
| Savable | yes, category: communication |
| Access | read only |
| PDO mapping | no |
| Allowed values | |
| Preset value | |
| Firmware version | FIR-v1426 |
| Change history | Firmware version FIR-v1738-B501312: The number of entries was changed from 6 to 7. |

Value description

| | |
|----------------|-------------------|
| Subindex | 00 _h |
| Name | Number Of Entries |
| Data type | UNSIGNED8 |
| Access | read only |
| PDO mapping | no |
| Allowed values | |
| Preset value | 06 _h |

| | |
|----------------|-----------------------|
| Subindex | 01 _h |
| Name | COB-ID |
| Data type | UNSIGNED32 |
| Access | read / write |
| PDO mapping | no |
| Allowed values | |
| Preset value | 00000000 _h |

| | |
|----------------|-------------------|
| Subindex | 02 _h |
| Name | Transmission Type |
| Data type | UNSIGNED8 |
| Access | read / write |
| PDO mapping | no |
| Allowed values | |
| Preset value | FF _h |

| | |
|----------------|-------------------|
| Subindex | 03 _h |
| Name | Inhibit Time |
| Data type | UNSIGNED16 |
| Access | read / write |
| PDO mapping | no |
| Allowed values | |
| Preset value | 0064 _h |

| | |
|----------------|---------------------|
| Subindex | 04 _h |
| Name | Compatibility Entry |
| Data type | UNSIGNED8 |
| Access | read / write |
| PDO mapping | no |
| Allowed values | |
| Preset value | 00 _h |

| | |
|----------|-----------------|
| Subindex | 05 _h |
|----------|-----------------|

| | |
|----------------|-------------------|
| Name | Event Timer |
| Data type | UNSIGNED16 |
| Access | read / write |
| PDO mapping | no |
| Allowed values | |
| Preset value | 0000 _h |

| | |
|----------------|------------------|
| Subindex | 06 _h |
| Name | SYNC Start Value |
| Data type | UNSIGNED8 |
| Access | read / write |
| PDO mapping | no |
| Allowed values | |
| Preset value | 00 _h |

Description

Subindex 01_h (COB-ID): The COB-ID is stored here.

Subindex 02_h (transmission type): A number is stored in this subindex that defines the time at which the received data become valid.

Subindex 3 (inhibit time): This can be used to set a time in 100 µs steps that must elapse after the sending of a PDO before the PDO is sent another time. This time only applies for asynchronous PDOs.

Subindex 4 (compatibility entry): This subindex has no function and exists only for compatibility reasons.

Subindex 5 (event timer): This time (in ms) can be used to trigger an *Event* which handles the copying of the data and the sending of the PDO.

Subindex 6 (sync start value): Here, the start value of the *Sync Counter* is entered beginning with which the *slave* is to initially respond to the sync and send the PDO. Thereafter, sending of the PDO is only dependent on *Transmission Type* (subindex 02_h). Not globally activated until a value greater than 1 is set in 1019_h Synchronous Counter Overflow Value.

For details, see chapter on [configuring the Tx-PDO mapping](#).

1804_h Transmit PDO 5 Communication Parameter

Function

Contains the communication parameters for the sending-side mapping (TX-PDO) 5. See chapter [Process Data Object \(PDO\)](#).

Object description

| | |
|----------------|--|
| Index | 1804 _h |
| Object name | Transmit PDO 5 Communication Parameter |
| Object Code | RECORD |
| Data type | PDO_COMMUNICATION_PARAMETER |
| Savable | yes, category: communication |
| Access | read only |
| PDO mapping | no |
| Allowed values | |

| | |
|------------------|--|
| Preset value | |
| Firmware version | FIR-v1614 |
| Change history | Firmware version FIR-v1738-B501312: The number of entries was changed from 6 to 7. |

Value description

| | |
|----------------|-------------------|
| Subindex | 00 _h |
| Name | Number Of Entries |
| Data type | UNSIGNED8 |
| Access | read only |
| PDO mapping | no |
| Allowed values | |
| Preset value | 06 _h |

| | |
|----------------|-----------------------|
| Subindex | 01 _h |
| Name | COB-ID |
| Data type | UNSIGNED32 |
| Access | read / write |
| PDO mapping | no |
| Allowed values | |
| Preset value | C0000000 _h |

| | |
|----------------|-------------------|
| Subindex | 02 _h |
| Name | Transmission Type |
| Data type | UNSIGNED8 |
| Access | read / write |
| PDO mapping | no |
| Allowed values | |
| Preset value | FF _h |

| | |
|----------------|-------------------|
| Subindex | 03 _h |
| Name | Inhibit Time |
| Data type | UNSIGNED16 |
| Access | read / write |
| PDO mapping | no |
| Allowed values | |
| Preset value | 0064 _h |

| | |
|-----------|---------------------|
| Subindex | 04 _h |
| Name | Compatibility Entry |
| Data type | UNSIGNED8 |
| Access | read / write |

| | |
|----------------|-------------------|
| PDO mapping | no |
| Allowed values | |
| Preset value | 00 _h |
| <hr/> | |
| Subindex | 05 _h |
| Name | Event Timer |
| Data type | UNSIGNED16 |
| Access | read / write |
| PDO mapping | no |
| Allowed values | |
| Preset value | 0000 _h |
| <hr/> | |
| Subindex | 06 _h |
| Name | SYNC Start Value |
| Data type | UNSIGNED8 |
| Access | read / write |
| PDO mapping | no |
| Allowed values | |
| Preset value | 00 _h |
| <hr/> | |

Description

Subindex 01_h (COB-ID): The COB-ID is stored here.

Subindex 02_h (transmission type): A number is stored in this subindex that defines the time at which the received data become valid.

Subindex 3 (inhibit time): This can be used to set a time in 100 µs steps that must elapse after the sending of a PDO before the PDO is sent another time. This time only applies for asynchronous PDOs.

Subindex 4 (compatibility entry): This subindex has no function and exists only for compatibility reasons.

Subindex 5 (event timer): This time (in ms) can be used to trigger an *Event* which handles the copying of the data and the sending of the PDO.

Subindex 6 (sync start value): Here, the start value of the *Sync Counter* is entered beginning with which the *slave* is to initially respond to the sync and send the PDO. Thereafter, sending of the PDO is only dependent on *Transmission Type* (subindex 02_h). Not globally activated until a value greater than 1 is set in 1019h Synchronous Counter Overflow Value.

For details, see chapter on configuring the Tx-PDO mapping.

1805h Transmit PDO 6 Communication Parameter

Function

Contains the communication parameters for the sending-side mapping (TX-PDO) 6. See chapter Process Data Object (PDO).

Object description

| | |
|-------------|--|
| Index | 1805 _h |
| Object name | Transmit PDO 6 Communication Parameter |

| | |
|------------------|--|
| Object Code | RECORD |
| Data type | PDO_COMMUNICATION_PARAMETER |
| Savable | yes, category: communication |
| Access | read only |
| PDO mapping | no |
| Allowed values | |
| Preset value | |
| Firmware version | FIR-v1614 |
| Change history | Firmware version FIR-v1738-B501312: The number of entries was changed from 6 to 7. |

Value description

| | |
|----------------|-------------------|
| Subindex | 00 _h |
| Name | Number Of Entries |
| Data type | UNSIGNED8 |
| Access | read only |
| PDO mapping | no |
| Allowed values | |
| Preset value | 06 _h |

| | |
|----------------|-----------------------|
| Subindex | 01 _h |
| Name | COB-ID |
| Data type | UNSIGNED32 |
| Access | read / write |
| PDO mapping | no |
| Allowed values | |
| Preset value | C0000000 _h |

| | |
|----------------|-------------------|
| Subindex | 02 _h |
| Name | Transmission Type |
| Data type | UNSIGNED8 |
| Access | read / write |
| PDO mapping | no |
| Allowed values | |
| Preset value | FF _h |

| | |
|----------------|-------------------|
| Subindex | 03 _h |
| Name | Inhibit Time |
| Data type | UNSIGNED16 |
| Access | read / write |
| PDO mapping | no |
| Allowed values | |
| Preset value | 0064 _h |

| | |
|----------------|---------------------|
| Subindex | 04 _h |
| Name | Compatibility Entry |
| Data type | UNSIGNED8 |
| Access | read / write |
| PDO mapping | no |
| Allowed values | |
| Preset value | 00 _h |
| <hr/> | |
| Subindex | 05 _h |
| Name | Event Timer |
| Data type | UNSIGNED16 |
| Access | read / write |
| PDO mapping | no |
| Allowed values | |
| Preset value | 0000 _h |
| <hr/> | |
| Subindex | 06 _h |
| Name | SYNC Start Value |
| Data type | UNSIGNED8 |
| Access | read / write |
| PDO mapping | no |
| Allowed values | |
| Preset value | 00 _h |

Description

Subindex 01_h (COB-ID): The COB-ID is stored here.

Subindex 02_h (transmission type): A number is stored in this subindex that defines the time at which the received data become valid.

Subindex 3 (inhibit time): This can be used to set a time in 100 μ s steps that must elapse after the sending of a PDO before the PDO is sent another time. This time only applies for asynchronous PDOs.

Subindex 4 (compatibility entry): This subindex has no function and exists only for compatibility reasons.

Subindex 5 (event timer): This time (in ms) can be used to trigger an *Event* which handles the copying of the data and the sending of the PDO.

Subindex 6 (sync start value): Here, the start value of the *Sync Counter* is entered beginning with which the *slave* is to initially respond to the sync and send the PDO. Thereafter, sending of the PDO is only dependent on *Transmission Type* (subindex 02_h). Not globally activated until a value greater than 1 is set in 1019h Synchronous Counter Overflow Value.

For details, see chapter on configuring the Tx-PDO mapping.

1806h Transmit PDO 7 Communication Parameter

Function

Contains the communication parameters for the sending-side mapping (TX-PDO) 7. See chapter Process Data Object (PDO).

Object description

| | |
|------------------|--|
| Index | 1806 _h |
| Object name | Transmit PDO 7 Communication Parameter |
| Object Code | RECORD |
| Data type | PDO_COMMUNICATION_PARAMETER |
| Savable | yes, category: communication |
| Access | read only |
| PDO mapping | no |
| Allowed values | |
| Preset value | |
| Firmware version | FIR-v1614 |
| Change history | Firmware version FIR-v1738-B501312: The number of entries was changed from 6 to 7. |

Value description

| | |
|----------------|-------------------|
| Subindex | 00 _h |
| Name | Number Of Entries |
| Data type | UNSIGNED8 |
| Access | read only |
| PDO mapping | no |
| Allowed values | |
| Preset value | 06 _h |

| | |
|----------------|-----------------------|
| Subindex | 01 _h |
| Name | COB-ID |
| Data type | UNSIGNED32 |
| Access | read / write |
| PDO mapping | no |
| Allowed values | |
| Preset value | C0000000 _h |

| | |
|----------------|-------------------|
| Subindex | 02 _h |
| Name | Transmission Type |
| Data type | UNSIGNED8 |
| Access | read / write |
| PDO mapping | no |
| Allowed values | |
| Preset value | FF _h |

| | |
|-----------|-----------------|
| Subindex | 03 _h |
| Name | Inhibit Time |
| Data type | UNSIGNED16 |

| | |
|----------------|-------------------|
| Access | read / write |
| PDO mapping | no |
| Allowed values | |
| Preset value | 0064 _h |

| | |
|----------------|---------------------|
| Subindex | 04 _h |
| Name | Compatibility Entry |
| Data type | UNSIGNED8 |
| Access | read / write |
| PDO mapping | no |
| Allowed values | |
| Preset value | 00 _h |

| | |
|----------------|-------------------|
| Subindex | 05 _h |
| Name | Event Timer |
| Data type | UNSIGNED16 |
| Access | read / write |
| PDO mapping | no |
| Allowed values | |
| Preset value | 0000 _h |

| | |
|----------------|------------------|
| Subindex | 06 _h |
| Name | SYNC Start Value |
| Data type | UNSIGNED8 |
| Access | read / write |
| PDO mapping | no |
| Allowed values | |
| Preset value | 00 _h |

Description

Subindex 01_h (COB-ID): The COB-ID is stored here.

Subindex 02_h (transmission type): A number is stored in this subindex that defines the time at which the received data become valid.

Subindex 3 (inhibit time): This can be used to set a time in 100 μ s steps that must elapse after the sending of a PDO before the PDO is sent another time. This time only applies for asynchronous PDOs.

Subindex 4 (compatibility entry): This subindex has no function and exists only for compatibility reasons.

Subindex 5 (event timer): This time (in ms) can be used to trigger an *Event* which handles the copying of the data and the sending of the PDO.

Subindex 6 (sync start value): Here, the start value of the *Sync Counter* is entered beginning with which the *slave* is to initially respond to the sync and send the PDO. Thereafter, sending of the PDO is only dependent on *Transmission Type* (subindex 02_h). Not globally activated until a value greater than 1 is set in 1019h Synchronous Counter Overflow Value.

For details, see chapter on configuring the Tx-PDO mapping.

1807h Transmit PDO 8 Communication Parameter

Function

Contains the communication parameters for the sending-side mapping (TX-PDO) 8. See chapter [Process Data Object \(PDO\)](#).

Object description

| | |
|------------------|--|
| Index | 1807 _h |
| Object name | Transmit PDO 8 Communication Parameter |
| Object Code | RECORD |
| Data type | PDO_COMMUNICATION_PARAMETER |
| Savable | yes, category: communication |
| Access | read only |
| PDO mapping | no |
| Allowed values | |
| Preset value | |
| Firmware version | FIR-v1614 |
| Change history | Firmware version FIR-v1738-B501312: The number of entries was changed from 6 to 7. |

Value description

| | |
|----------------|-------------------|
| Subindex | 00 _h |
| Name | Number Of Entries |
| Data type | UNSIGNED8 |
| Access | read only |
| PDO mapping | no |
| Allowed values | |
| Preset value | 06 _h |

| | |
|----------------|-----------------------|
| Subindex | 01 _h |
| Name | COB-ID |
| Data type | UNSIGNED32 |
| Access | read / write |
| PDO mapping | no |
| Allowed values | |
| Preset value | C0000000 _h |

| | |
|----------------|-------------------|
| Subindex | 02 _h |
| Name | Transmission Type |
| Data type | UNSIGNED8 |
| Access | read / write |
| PDO mapping | no |
| Allowed values | |

| | |
|----------------|---------------------|
| Preset value | FF _h |
| Subindex | 03 _h |
| Name | Inhibit Time |
| Data type | UNSIGNED16 |
| Access | read / write |
| PDO mapping | no |
| Allowed values | |
| Preset value | 0064 _h |
| Subindex | 04 _h |
| Name | Compatibility Entry |
| Data type | UNSIGNED8 |
| Access | read / write |
| PDO mapping | no |
| Allowed values | |
| Preset value | 00 _h |
| Subindex | 05 _h |
| Name | Event Timer |
| Data type | UNSIGNED16 |
| Access | read / write |
| PDO mapping | no |
| Allowed values | |
| Preset value | 0000 _h |
| Subindex | 06 _h |
| Name | SYNC Start Value |
| Data type | UNSIGNED8 |
| Access | read / write |
| PDO mapping | no |
| Allowed values | |
| Preset value | 00 _h |

Description

Subindex 01_h (COB-ID): The COB-ID is stored here.

Subindex 02_h (transmission type): A number is stored in this subindex that defines the time at which the received data become valid.

Subindex 3 (inhibit time): This can be used to set a time in 100 µs steps that must elapse after the sending of a PDO before the PDO is sent another time. This time only applies for asynchronous PDOs.

Subindex 4 (compatibility entry): This subindex has no function and exists only for compatibility reasons.

Subindex 5 (event timer): This time (in ms) can be used to trigger an *Event* which handles the copying of the data and the sending of the PDO.

Subindex 6 (sync start value): Here, the start value of the *Sync Counter* is entered beginning with which the *slave* is to initially respond to the sync and send the PDO. Thereafter, sending of the PDO is only dependent on *Transmission Type* (subindex 02_h). Not globally activated until a value greater than 1 is set in 1019h Synchronous Counter Overflow Value.

For details, see chapter on configuring the Tx-PDO mapping.

1A00h Transmit PDO 1 Mapping Parameter

Function

This object contains the mapping parameters for PDOs that the controller can send (TX-PDO 1).

Object description

| | |
|------------------|--|
| Index | 1A00 _h |
| Object name | Transmit PDO 1 Mapping Parameter |
| Object Code | RECORD |
| Data type | PDO_MAPPING |
| Savable | yes, category: communication |
| Firmware version | FIR-v1426 |
| Change history | Firmware version FIR-v1426: "Heading" entry changed from "1A00h Drive Status" to "1A00h Transmit PDO 1 Mapping Parameter". Firmware version FIR-v1426: "Object Name" entry changed from "Drive Status" to "Transmit PDO 1 Mapping Parameter". |

Value description

| | |
|----------------|-------------------------|
| Subindex | 00 _h |
| Name | Number Of Entries |
| Data type | UNSIGNED8 |
| Access | read / write |
| PDO mapping | no |
| Allowed values | |
| Preset value | 02 _h |
| Subindex | 01 _h |
| Name | 1st Object To Be Mapped |
| Data type | UNSIGNED32 |
| Access | read / write |
| PDO mapping | no |
| Allowed values | |
| Preset value | 60410010 _h |
| Subindex | 02 _h |
| Name | 2nd Object To Be Mapped |
| Data type | UNSIGNED32 |
| Access | read / write |

| | |
|----------------|-------------------------|
| PDO mapping | no |
| Allowed values | |
| Preset value | 60610008 _h |
| <hr/> | |
| Subindex | 03 _h |
| Name | 3rd Object To Be Mapped |
| Data type | UNSIGNED32 |
| Access | read / write |
| PDO mapping | no |
| Allowed values | |
| Preset value | 00000000 _h |
| <hr/> | |
| Subindex | 04 _h |
| Name | 4th Object To Be Mapped |
| Data type | UNSIGNED32 |
| Access | read / write |
| PDO mapping | no |
| Allowed values | |
| Preset value | 00000000 _h |
| <hr/> | |
| Subindex | 05 _h |
| Name | 5th Object To Be Mapped |
| Data type | UNSIGNED32 |
| Access | read / write |
| PDO mapping | no |
| Allowed values | |
| Preset value | 00000000 _h |
| <hr/> | |
| Subindex | 06 _h |
| Name | 6th Object To Be Mapped |
| Data type | UNSIGNED32 |
| Access | read / write |
| PDO mapping | no |
| Allowed values | |
| Preset value | 00000000 _h |
| <hr/> | |
| Subindex | 07 _h |
| Name | 7th Object To Be Mapped |
| Data type | UNSIGNED32 |
| Access | read / write |
| PDO mapping | no |
| Allowed values | |
| Preset value | 00000000 _h |

| | |
|----------------|-------------------------|
| Subindex | 08 _h |
| Name | 8th Object To Be Mapped |
| Data type | UNSIGNED32 |
| Access | read / write |
| PDO mapping | no |
| Allowed values | |
| Preset value | 00000000 _h |

Description

Each subindex (1–8) describes a different mapped object.

A mapping entry consists of four bytes, which are structured according to the following graphic.

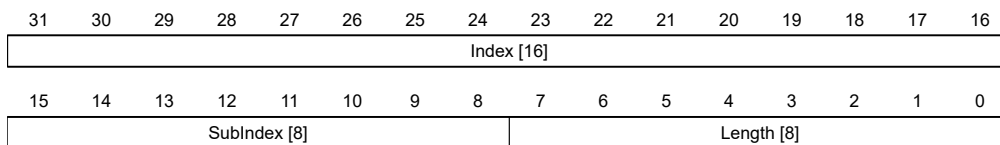

Index [16]

This contains the index of the object to be mapped.

Subindex [8]

This contains the subindex of the object to be mapped.

Length [8]

This contains the length of the object to be mapped in units of bits.

1A01h Transmit PDO 2 Mapping Parameter

Function

This object contains the mapping parameters for PDOs that the controller can send (TX-PDO 2).

Object description

| | |
|------------------|---|
| Index | 1A01 _h |
| Object name | Transmit PDO 2 Mapping Parameter |
| Object Code | RECORD |
| Data type | PDO_MAPPING |
| Savable | yes, category: communication |
| Firmware version | FIR-v1426 |
| Change history | <p>Firmware version FIR-v1426: "Heading" entry changed from "1A01h Positioning Status" to "1A01h Transmit PDO 2 Mapping Parameter".</p> <p>Firmware version FIR-v1426: "Object Name" entry changed from "Positioning Status" to "Transmit PDO 2 Mapping Parameter".</p> |

Value description

| | |
|----------|-----------------|
| Subindex | 00 _h |
|----------|-----------------|

| | |
|----------------|-------------------|
| Name | Number Of Entries |
| Data type | UNSIGNED8 |
| Access | read / write |
| PDO mapping | no |
| Allowed values | |
| Preset value | 01 _h |

| | |
|----------------|-------------------------|
| Subindex | 01 _h |
| Name | 1st Object To Be Mapped |
| Data type | UNSIGNED32 |
| Access | read / write |
| PDO mapping | no |
| Allowed values | |
| Preset value | 60640020 _h |

| | |
|----------------|-------------------------|
| Subindex | 02 _h |
| Name | 2nd Object To Be Mapped |
| Data type | UNSIGNED32 |
| Access | read / write |
| PDO mapping | no |
| Allowed values | |
| Preset value | 00000000 _h |

| | |
|----------------|-------------------------|
| Subindex | 03 _h |
| Name | 3rd Object To Be Mapped |
| Data type | UNSIGNED32 |
| Access | read / write |
| PDO mapping | no |
| Allowed values | |
| Preset value | 00000000 _h |

| | |
|----------------|-------------------------|
| Subindex | 04 _h |
| Name | 4th Object To Be Mapped |
| Data type | UNSIGNED32 |
| Access | read / write |
| PDO mapping | no |
| Allowed values | |
| Preset value | 00000000 _h |

| | |
|-----------|-------------------------|
| Subindex | 05 _h |
| Name | 5th Object To Be Mapped |
| Data type | UNSIGNED32 |
| Access | read / write |

| | |
|----------------|-------------------------|
| PDO mapping | no |
| Allowed values | |
| Preset value | 00000000 _h |
| <hr/> | |
| Subindex | 06 _h |
| Name | 6th Object To Be Mapped |
| Data type | UNSIGNED32 |
| Access | read / write |
| PDO mapping | no |
| Allowed values | |
| Preset value | 00000000 _h |
| <hr/> | |
| Subindex | 07 _h |
| Name | 7th Object To Be Mapped |
| Data type | UNSIGNED32 |
| Access | read / write |
| PDO mapping | no |
| Allowed values | |
| Preset value | 00000000 _h |
| <hr/> | |
| Subindex | 08 _h |
| Name | 8th Object To Be Mapped |
| Data type | UNSIGNED32 |
| Access | read / write |
| PDO mapping | no |
| Allowed values | |
| Preset value | 00000000 _h |

Description

Each subindex (1–8) describes a different mapped object.

A mapping entry consists of four bytes, which are structured according to the following graphic.

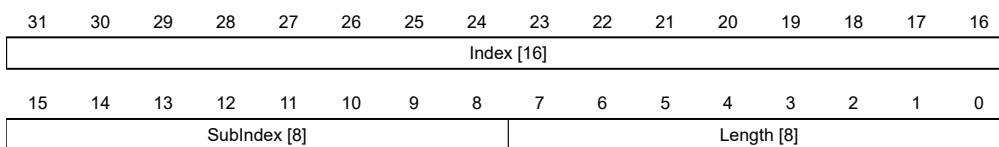

Index [16]

This contains the index of the object to be mapped.

Subindex [8]

This contains the subindex of the object to be mapped.

Length [8]

This contains the length of the object to be mapped in units of bits.

1A02h Transmit PDO 3 Mapping Parameter

Function

This object contains the mapping parameters for PDOs that the controller can send (TX-PDO 3).

Object description

| | |
|------------------|---|
| Index | 1A02 _h |
| Object name | Transmit PDO 3 Mapping Parameter |
| Object Code | RECORD |
| Data type | PDO_MAPPING |
| Savable | yes, category: communication |
| Firmware version | FIR-v1426 |
| Change history | <p>Firmware version FIR-v1426: "Heading" entry changed from "1A02h Velocity Status" to "1A02h Transmit PDO 3 Mapping Parameter".</p> <p>Firmware version FIR-v1426: "Object Name" entry changed from "Velocity Status" to "Transmit PDO 3 Mapping Parameter".</p> |

Value description

| | |
|----------------|-------------------------|
| Subindex | 00 _h |
| Name | Number Of Entries |
| Data type | UNSIGNED8 |
| Access | read / write |
| PDO mapping | no |
| Allowed values | |
| Preset value | 01 _h |
| Subindex | 01 _h |
| Name | 1st Object To Be Mapped |
| Data type | UNSIGNED32 |
| Access | read / write |
| PDO mapping | no |
| Allowed values | |
| Preset value | 60440010 _h |
| Subindex | 02 _h |
| Name | 2nd Object To Be Mapped |
| Data type | UNSIGNED32 |
| Access | read / write |
| PDO mapping | no |
| Allowed values | |
| Preset value | 00000000 _h |

| | |
|----------------|-------------------------|
| Subindex | 03 _h |
| Name | 3rd Object To Be Mapped |
| Data type | UNSIGNED32 |
| Access | read / write |
| PDO mapping | no |
| Allowed values | |
| Preset value | 00000000 _h |

| | |
|----------------|-------------------------|
| Subindex | 04 _h |
| Name | 4th Object To Be Mapped |
| Data type | UNSIGNED32 |
| Access | read / write |
| PDO mapping | no |
| Allowed values | |
| Preset value | 00000000 _h |

| | |
|----------------|-------------------------|
| Subindex | 05 _h |
| Name | 5th Object To Be Mapped |
| Data type | UNSIGNED32 |
| Access | read / write |
| PDO mapping | no |
| Allowed values | |
| Preset value | 00000000 _h |

| | |
|----------------|-------------------------|
| Subindex | 06 _h |
| Name | 6th Object To Be Mapped |
| Data type | UNSIGNED32 |
| Access | read / write |
| PDO mapping | no |
| Allowed values | |
| Preset value | 00000000 _h |

| | |
|----------------|-------------------------|
| Subindex | 07 _h |
| Name | 7th Object To Be Mapped |
| Data type | UNSIGNED32 |
| Access | read / write |
| PDO mapping | no |
| Allowed values | |
| Preset value | 00000000 _h |

| | |
|-----------|-------------------------|
| Subindex | 08 _h |
| Name | 8th Object To Be Mapped |
| Data type | UNSIGNED32 |

| | |
|----------------|-----------------------|
| Access | read / write |
| PDO mapping | no |
| Allowed values | |
| Preset value | 00000000 _h |

Description

Each subindex (1–8) describes a different mapped object.

A mapping entry consists of four bytes, which are structured according to the following graphic.

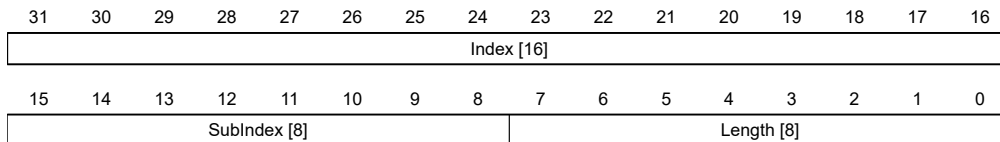

Index [16]

This contains the index of the object to be mapped.

Subindex [8]

This contains the subindex of the object to be mapped.

Length [8]

This contains the length of the object to be mapped in units of bits.

1A03h Transmit PDO 4 Mapping Parameter

Function

This object contains the mapping parameters for PDOs that the controller can send (TX-PDO 4).

Object description

| | |
|------------------|---|
| Index | 1A03 _h |
| Object name | Transmit PDO 4 Mapping Parameter |
| Object Code | RECORD |
| Data type | PDO_MAPPING |
| Savable | yes, category: communication |
| Firmware version | FIR-v1426 |
| Change history | <p>Firmware version FIR-v1426: "Heading" entry changed from "1A03h Input Status" to "1A03h Transmit PDO 4 Mapping Parameter".</p> <p>Firmware version FIR-v1426: "Object Name" entry changed from "Input Status" to "Transmit PDO 4 Mapping Parameter".</p> |

Value description

| | |
|-----------|-------------------|
| Subindex | 00 _h |
| Name | Number Of Entries |
| Data type | UNSIGNED8 |
| Access | read / write |

| | |
|----------------|-------------------------|
| PDO mapping | no |
| Allowed values | |
| Preset value | 01 _h |
| <hr/> | |
| Subindex | 01 _h |
| Name | 1st Object To Be Mapped |
| Data type | UNSIGNED32 |
| Access | read / write |
| PDO mapping | no |
| Allowed values | |
| Preset value | 60FD0020 _h |
| <hr/> | |
| Subindex | 02 _h |
| Name | 2nd Object To Be Mapped |
| Data type | UNSIGNED32 |
| Access | read / write |
| PDO mapping | no |
| Allowed values | |
| Preset value | 00000000 _h |
| <hr/> | |
| Subindex | 03 _h |
| Name | 3rd Object To Be Mapped |
| Data type | UNSIGNED32 |
| Access | read / write |
| PDO mapping | no |
| Allowed values | |
| Preset value | 00000000 _h |
| <hr/> | |
| Subindex | 04 _h |
| Name | 4th Object To Be Mapped |
| Data type | UNSIGNED32 |
| Access | read / write |
| PDO mapping | no |
| Allowed values | |
| Preset value | 00000000 _h |
| <hr/> | |
| Subindex | 05 _h |
| Name | 5th Object To Be Mapped |
| Data type | UNSIGNED32 |
| Access | read / write |
| PDO mapping | no |
| Allowed values | |
| Preset value | 00000000 _h |

| | |
|----------------|-------------------------|
| Subindex | 06 _h |
| Name | 6th Object To Be Mapped |
| Data type | UNSIGNED32 |
| Access | read / write |
| PDO mapping | no |
| Allowed values | |
| Preset value | 00000000 _h |

| | |
|----------------|-------------------------|
| Subindex | 07 _h |
| Name | 7th Object To Be Mapped |
| Data type | UNSIGNED32 |
| Access | read / write |
| PDO mapping | no |
| Allowed values | |
| Preset value | 00000000 _h |

| | |
|----------------|-------------------------|
| Subindex | 08 _h |
| Name | 8th Object To Be Mapped |
| Data type | UNSIGNED32 |
| Access | read / write |
| PDO mapping | no |
| Allowed values | |
| Preset value | 00000000 _h |

Description

Each subindex (1–8) describes a different mapped object.

A mapping entry consists of four bytes, which are structured according to the following graphic.

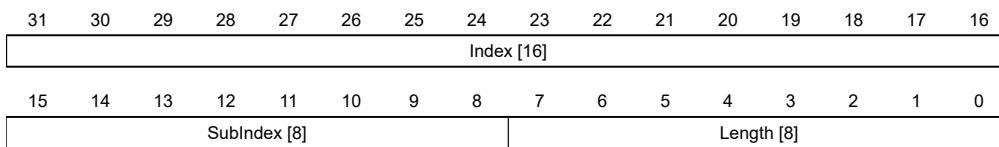

Index [16]

This contains the index of the object to be mapped.

Subindex [8]

This contains the subindex of the object to be mapped.

Length [8]

This contains the length of the object to be mapped in units of bits.

1A04h Transmit PDO 5 Mapping Parameter

Function

This object contains the mapping parameters for PDOs that the controller can send (TX-PDO 5). The PDO was previously configured via [1804h Transmit PDO 5 Communication Parameter](#). See chapter [Process Data Object \(PDO\)](#).

Object description

| | |
|------------------|----------------------------------|
| Index | 1A04 _h |
| Object name | Transmit PDO 5 Mapping Parameter |
| Object Code | RECORD |
| Data type | PDO_MAPPING |
| Savable | yes, category: communication |
| Access | read / write |
| PDO mapping | no |
| Allowed values | |
| Preset value | |
| Firmware version | FIR-v1614 |
| Change history | |

Value description

| | |
|----------------|-------------------|
| Subindex | 00 _h |
| Name | Number Of Entries |
| Data type | UNSIGNED8 |
| Access | read / write |
| PDO mapping | no |
| Allowed values | |
| Preset value | 00 _h |

| | |
|----------------|-------------------------|
| Subindex | 01 _h |
| Name | 1st Object To Be Mapped |
| Data type | UNSIGNED32 |
| Access | read / write |
| PDO mapping | no |
| Allowed values | |
| Preset value | 00000000 _h |

| | |
|----------------|-------------------------|
| Subindex | 02 _h |
| Name | 2nd Object To Be Mapped |
| Data type | UNSIGNED32 |
| Access | read / write |
| PDO mapping | no |
| Allowed values | |
| Preset value | 00000000 _h |

| | |
|----------------|-------------------------|
| Subindex | 03 _h |
| Name | 3rd Object To Be Mapped |
| Data type | UNSIGNED32 |
| Access | read / write |
| PDO mapping | no |
| Allowed values | |
| Preset value | 00000000 _h |

| | |
|----------------|-------------------------|
| Subindex | 04 _h |
| Name | 4th Object To Be Mapped |
| Data type | UNSIGNED32 |
| Access | read / write |
| PDO mapping | no |
| Allowed values | |
| Preset value | 00000000 _h |

| | |
|----------------|-------------------------|
| Subindex | 05 _h |
| Name | 5th Object To Be Mapped |
| Data type | UNSIGNED32 |
| Access | read / write |
| PDO mapping | no |
| Allowed values | |
| Preset value | 00000000 _h |

| | |
|----------------|-------------------------|
| Subindex | 06 _h |
| Name | 6th Object To Be Mapped |
| Data type | UNSIGNED32 |
| Access | read / write |
| PDO mapping | no |
| Allowed values | |
| Preset value | 00000000 _h |

| | |
|----------------|-------------------------|
| Subindex | 07 _h |
| Name | 7th Object To Be Mapped |
| Data type | UNSIGNED32 |
| Access | read / write |
| PDO mapping | no |
| Allowed values | |
| Preset value | 00000000 _h |

| | |
|-----------|-------------------------|
| Subindex | 08 _h |
| Name | 8th Object To Be Mapped |
| Data type | UNSIGNED32 |

| | |
|----------------|-----------------------|
| Access | read / write |
| PDO mapping | no |
| Allowed values | |
| Preset value | 00000000 _h |

Description

Each subindex (1–8) describes a different mapped object.

A mapping entry consists of four bytes, which are structured according to the following graphic.

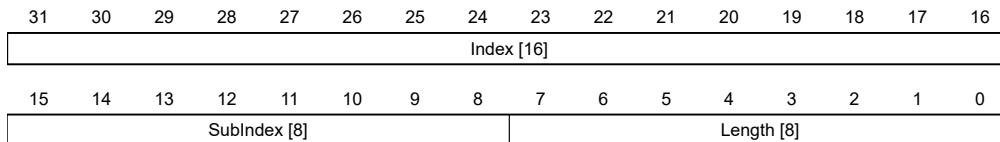

Index [16]

This contains the index of the object to be mapped.

Subindex [8]

This contains the subindex of the object to be mapped.

Length [8]

This contains the length of the object to be mapped in units of bits.

1A05h Transmit PDO 6 Mapping Parameter

Function

This object contains the mapping parameters for PDOs that the controller can send (TX-PDO 6). The PDO was previously configured via [1805h Transmit PDO 6 Communication Parameter](#). See chapter [Process Data Object \(PDO\)](#).

Object description

| | |
|------------------|----------------------------------|
| Index | 1A05 _h |
| Object name | Transmit PDO 6 Mapping Parameter |
| Object Code | RECORD |
| Data type | PDO_MAPPING |
| Savable | yes, category: communication |
| Access | read / write |
| PDO mapping | no |
| Allowed values | |
| Preset value | |
| Firmware version | FIR-v1614 |
| Change history | |

Value description

| | |
|----------|-------------------|
| Subindex | 00 _h |
| Name | Number Of Entries |

| | |
|----------------|-------------------------|
| Data type | UNSIGNED8 |
| Access | read / write |
| PDO mapping | no |
| Allowed values | |
| Preset value | 00 _h |
| <hr/> | |
| Subindex | 01 _h |
| Name | 1st Object To Be Mapped |
| Data type | UNSIGNED32 |
| Access | read / write |
| PDO mapping | no |
| Allowed values | |
| Preset value | 00000000 _h |
| <hr/> | |
| Subindex | 02 _h |
| Name | 2nd Object To Be Mapped |
| Data type | UNSIGNED32 |
| Access | read / write |
| PDO mapping | no |
| Allowed values | |
| Preset value | 00000000 _h |
| <hr/> | |
| Subindex | 03 _h |
| Name | 3rd Object To Be Mapped |
| Data type | UNSIGNED32 |
| Access | read / write |
| PDO mapping | no |
| Allowed values | |
| Preset value | 00000000 _h |
| <hr/> | |
| Subindex | 04 _h |
| Name | 4th Object To Be Mapped |
| Data type | UNSIGNED32 |
| Access | read / write |
| PDO mapping | no |
| Allowed values | |
| Preset value | 00000000 _h |
| <hr/> | |
| Subindex | 05 _h |
| Name | 5th Object To Be Mapped |
| Data type | UNSIGNED32 |
| Access | read / write |
| PDO mapping | no |

| | |
|----------------|-------------------------|
| Allowed values | |
| Preset value | 00000000 _h |
| <hr/> | |
| Subindex | 06 _h |
| Name | 6th Object To Be Mapped |
| Data type | UNSIGNED32 |
| Access | read / write |
| PDO mapping | no |
| Allowed values | |
| Preset value | 00000000 _h |
| <hr/> | |
| Subindex | 07 _h |
| Name | 7th Object To Be Mapped |
| Data type | UNSIGNED32 |
| Access | read / write |
| PDO mapping | no |
| Allowed values | |
| Preset value | 00000000 _h |
| <hr/> | |
| Subindex | 08 _h |
| Name | 8th Object To Be Mapped |
| Data type | UNSIGNED32 |
| Access | read / write |
| PDO mapping | no |
| Allowed values | |
| Preset value | 00000000 _h |

Description

Each subindex (1–8) describes a different mapped object.

A mapping entry consists of four bytes, which are structured according to the following graphic.

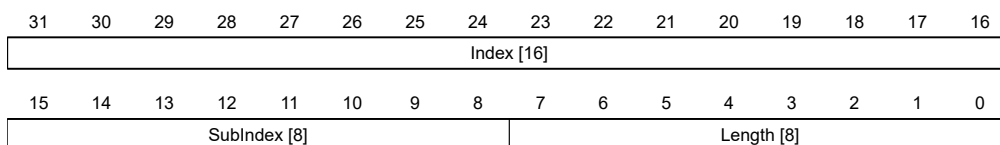

Index [16]

This contains the index of the object to be mapped.

Subindex [8]

This contains the subindex of the object to be mapped.

Length [8]

This contains the length of the object to be mapped in units of bits.

1A06h Transmit PDO 7 Mapping Parameter

Function

This object contains the mapping parameters for PDOs that the controller can send (TX-PDO 7). The PDO was previously configured via [1806h Transmit PDO 7 Communication Parameter](#). See chapter [Process Data Object \(PDO\)](#).

Object description

| | |
|------------------|----------------------------------|
| Index | 1A06 _h |
| Object name | Transmit PDO 7 Mapping Parameter |
| Object Code | RECORD |
| Data type | PDO_MAPPING |
| Savable | yes, category: communication |
| Access | read / write |
| PDO mapping | no |
| Allowed values | |
| Preset value | |
| Firmware version | FIR-v1614 |
| Change history | |

Value description

| | |
|----------------|-------------------|
| Subindex | 00 _h |
| Name | Number Of Entries |
| Data type | UNSIGNED8 |
| Access | read / write |
| PDO mapping | no |
| Allowed values | |
| Preset value | 00 _h |

| | |
|----------------|-------------------------|
| Subindex | 01 _h |
| Name | 1st Object To Be Mapped |
| Data type | UNSIGNED32 |
| Access | read / write |
| PDO mapping | no |
| Allowed values | |
| Preset value | 00000000 _h |

| | |
|----------------|-------------------------|
| Subindex | 02 _h |
| Name | 2nd Object To Be Mapped |
| Data type | UNSIGNED32 |
| Access | read / write |
| PDO mapping | no |
| Allowed values | |
| Preset value | 00000000 _h |

| | |
|----------------|-------------------------|
| Subindex | 03 _h |
| Name | 3rd Object To Be Mapped |
| Data type | UNSIGNED32 |
| Access | read / write |
| PDO mapping | no |
| Allowed values | |
| Preset value | 00000000 _h |

| | |
|----------------|-------------------------|
| Subindex | 04 _h |
| Name | 4th Object To Be Mapped |
| Data type | UNSIGNED32 |
| Access | read / write |
| PDO mapping | no |
| Allowed values | |
| Preset value | 00000000 _h |

| | |
|----------------|-------------------------|
| Subindex | 05 _h |
| Name | 5th Object To Be Mapped |
| Data type | UNSIGNED32 |
| Access | read / write |
| PDO mapping | no |
| Allowed values | |
| Preset value | 00000000 _h |

| | |
|----------------|-------------------------|
| Subindex | 06 _h |
| Name | 6th Object To Be Mapped |
| Data type | UNSIGNED32 |
| Access | read / write |
| PDO mapping | no |
| Allowed values | |
| Preset value | 00000000 _h |

| | |
|----------------|-------------------------|
| Subindex | 07 _h |
| Name | 7th Object To Be Mapped |
| Data type | UNSIGNED32 |
| Access | read / write |
| PDO mapping | no |
| Allowed values | |
| Preset value | 00000000 _h |

| | |
|-----------|-------------------------|
| Subindex | 08 _h |
| Name | 8th Object To Be Mapped |
| Data type | UNSIGNED32 |

| | |
|----------------|-----------------------|
| Access | read / write |
| PDO mapping | no |
| Allowed values | |
| Preset value | 00000000 _h |

Description

Each subindex (1–8) describes a different mapped object.

A mapping entry consists of four bytes, which are structured according to the following graphic.

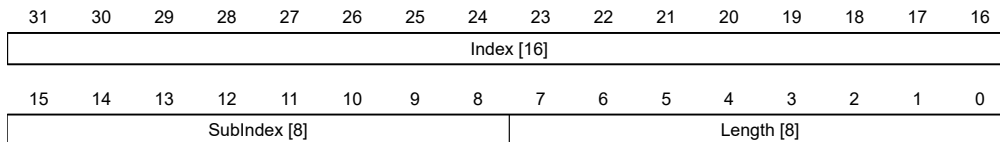

Index [16]

This contains the index of the object to be mapped.

Subindex [8]

This contains the subindex of the object to be mapped.

Length [8]

This contains the length of the object to be mapped in units of bits.

1A07h Transmit PDO 8 Mapping Parameter

Function

This object contains the mapping parameters for PDOs that the controller can send (TX-PDO 8). The PDO was previously configured via [1807h Transmit PDO 8 Communication Parameter](#). See chapter [Process Data Object \(PDO\)](#).

Object description

| | |
|------------------|----------------------------------|
| Index | 1A07 _h |
| Object name | Transmit PDO 8 Mapping Parameter |
| Object Code | RECORD |
| Data type | PDO_MAPPING |
| Savable | yes, category: communication |
| Access | read / write |
| PDO mapping | no |
| Allowed values | |
| Preset value | |
| Firmware version | FIR-v1614 |
| Change history | |

Value description

| | |
|----------|-------------------|
| Subindex | 00 _h |
| Name | Number Of Entries |

| | |
|----------------|-----------------|
| Data type | UNSIGNED8 |
| Access | read / write |
| PDO mapping | no |
| Allowed values | |
| Preset value | 00 _h |

| | |
|----------------|-------------------------|
| Subindex | 01 _h |
| Name | 1st Object To Be Mapped |
| Data type | UNSIGNED32 |
| Access | read / write |
| PDO mapping | no |
| Allowed values | |
| Preset value | 00000000 _h |

| | |
|----------------|-------------------------|
| Subindex | 02 _h |
| Name | 2nd Object To Be Mapped |
| Data type | UNSIGNED32 |
| Access | read / write |
| PDO mapping | no |
| Allowed values | |
| Preset value | 00000000 _h |

| | |
|----------------|-------------------------|
| Subindex | 03 _h |
| Name | 3rd Object To Be Mapped |
| Data type | UNSIGNED32 |
| Access | read / write |
| PDO mapping | no |
| Allowed values | |
| Preset value | 00000000 _h |

| | |
|----------------|-------------------------|
| Subindex | 04 _h |
| Name | 4th Object To Be Mapped |
| Data type | UNSIGNED32 |
| Access | read / write |
| PDO mapping | no |
| Allowed values | |
| Preset value | 00000000 _h |

| | |
|-------------|-------------------------|
| Subindex | 05 _h |
| Name | 5th Object To Be Mapped |
| Data type | UNSIGNED32 |
| Access | read / write |
| PDO mapping | no |

| | |
|----------------|-------------------------|
| Allowed values | |
| Preset value | 00000000 _h |
| <hr/> | |
| Subindex | 06 _h |
| Name | 6th Object To Be Mapped |
| Data type | UNSIGNED32 |
| Access | read / write |
| PDO mapping | no |
| Allowed values | |
| Preset value | 00000000 _h |
| <hr/> | |
| Subindex | 07 _h |
| Name | 7th Object To Be Mapped |
| Data type | UNSIGNED32 |
| Access | read / write |
| PDO mapping | no |
| Allowed values | |
| Preset value | 00000000 _h |
| <hr/> | |
| Subindex | 08 _h |
| Name | 8th Object To Be Mapped |
| Data type | UNSIGNED32 |
| Access | read / write |
| PDO mapping | no |
| Allowed values | |
| Preset value | 00000000 _h |

Description

Each subindex (1–8) describes a different mapped object.

A mapping entry consists of four bytes, which are structured according to the following graphic.

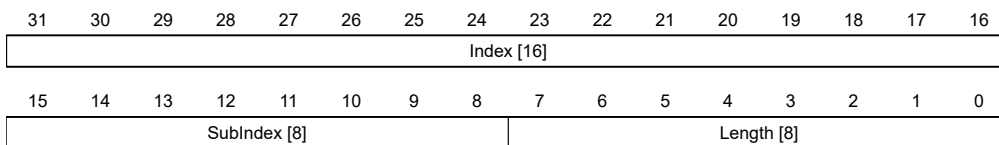

Index [16]

This contains the index of the object to be mapped.

Subindex [8]

This contains the subindex of the object to be mapped.

Length [8]

This contains the length of the object to be mapped in units of bits.

1F50h Program Data

Function

This object is used to program memory areas of the controller. Each entry stands for a certain memory area.

Object description

| | |
|------------------|-------------------|
| Index | 1F50 _h |
| Object name | Program Data |
| Object Code | ARRAY |
| Data type | DOMAIN |
| Savable | no |
| Access | read only |
| PDO mapping | no |
| Allowed values | |
| Preset value | |
| Firmware version | FIR-v1540 |
| Change history | |

Value description

| | |
|----------------|-------------------|
| Subindex | 00 _h |
| Name | Number Of Entries |
| Data type | UNSIGNED8 |
| Access | read only |
| PDO mapping | no |
| Allowed values | |
| Preset value | 02 _h |

| | |
|----------------|----------------------------------|
| Subindex | 01 _h |
| Name | Program Data Bootloader/firmware |
| Data type | DOMAIN |
| Access | read / write |
| PDO mapping | no |
| Allowed values | |
| Preset value | 0 |

| | |
|----------------|--------------------|
| Subindex | 02 _h |
| Name | Program Data NanoJ |
| Data type | DOMAIN |
| Access | read / write |
| PDO mapping | no |
| Allowed values | |
| Preset value | 0 |

1F51h Program Control

Function

This object is used to control the programming of memory areas of the controller. Each entry stands for a certain memory area.

Object description

| | |
|------------------|-------------------|
| Index | 1F51 _h |
| Object name | Program Control |
| Object Code | ARRAY |
| Data type | UNSIGNED8 |
| Savable | no |
| Access | read only |
| PDO mapping | no |
| Allowed values | |
| Preset value | |
| Firmware version | FIR-v1540 |
| Change history | |

Value description

| | |
|----------------|-------------------|
| Subindex | 00 _h |
| Name | Number Of Entries |
| Data type | UNSIGNED8 |
| Access | read only |
| PDO mapping | no |
| Allowed values | |
| Preset value | 02 _h |

| | |
|----------------|-------------------------------------|
| Subindex | 01 _h |
| Name | Program Control Bootloader/firmware |
| Data type | UNSIGNED8 |
| Access | read / write |
| PDO mapping | no |
| Allowed values | |
| Preset value | 00 _h |

| | |
|----------------|-----------------------|
| Subindex | 02 _h |
| Name | Program Control NanoJ |
| Data type | UNSIGNED8 |
| Access | read / write |
| PDO mapping | no |
| Allowed values | |
| Preset value | 00 _h |

1F57h Program Status

Function

This object indicates the programming status during the programming of memory areas of the controller. Each entry stands for a certain memory area.

Object description

| | |
|------------------|-------------------|
| Index | 1F57 _h |
| Object name | Program Status |
| Object Code | ARRAY |
| Data type | UNSIGNED32 |
| Savable | no |
| Access | read only |
| PDO mapping | no |
| Allowed values | |
| Preset value | |
| Firmware version | FIR-v1540 |
| Change history | |

Value description

| | |
|----------------|-------------------|
| Subindex | 00 _h |
| Name | Number Of Entries |
| Data type | UNSIGNED8 |
| Access | read only |
| PDO mapping | no |
| Allowed values | |
| Preset value | 02 _h |

| | |
|----------------|------------------------------------|
| Subindex | 01 _h |
| Name | Program Status Bootloader/firmware |
| Data type | UNSIGNED32 |
| Access | read only |
| PDO mapping | no |
| Allowed values | |
| Preset value | 00000000 _h |

| | |
|----------------|-----------------------|
| Subindex | 02 _h |
| Name | Program Status NanoJ |
| Data type | UNSIGNED32 |
| Access | read only |
| PDO mapping | no |
| Allowed values | |
| Preset value | 00000000 _h |

1F80h NMT Startup

Function

In this object you can set whether, after starting the controller, the state is automatically switched to the NMT state *Operational*. See also chapter [Network Management \(NMT\)](#).

Object description

| | |
|------------------|------------------------------|
| Index | 1F80 _h |
| Object name | NMT Startup |
| Object Code | VARIABLE |
| Data type | UNSIGNED32 |
| Savable | yes, category: communication |
| Access | read / write |
| PDO mapping | no |
| Allowed values | |
| Preset value | 00000000 _h |
| Firmware version | FIR-v1748-B531667 |
| Change history | |

Description

- Value "0"_h: The state of the NMT state machine after initialization is *Pre-Operational*.
- Value "8"_h (bit 3): The state of the NMT state machine after initialization is *Operational*.

2005h CANopen Baudrate

Function

This object contains the baud rate of the CANopen bus.

Object description

| | |
|------------------|--|
| Index | 2005 _h |
| Object name | CANopen Baudrate |
| Object Code | VARIABLE |
| Data type | UNSIGNED8 |
| Savable | yes, category: CANopen |
| Access | read / write |
| PDO mapping | no |
| Allowed values | |
| Preset value | 88 _h |
| Firmware version | FIR-v1426 |
| Change history | Firmware version FIR-v1748-B531667: "Savable" entry changed from "yes, category: communication" to "yes, category: CANopen". |

Description

The baud rates are to be set according to the following table. Each value outside of this table is interpreted as 1000 kBd.

| | Value | | Baud rate in kBd |
|-----|-------|------|---------------------|
| | dec | hex | |
| 129 | 81 | 10 | |
| 130 | 82 | 20 | |
| 131 | 83 | 50 | |
| 132 | 84 | 125 | |
| 133 | 85 | 250 | |
| 134 | 86 | 500 | |
| 136 | 88 | 1000 | |

2007h CANopen Config

Function

This object can be used to perform various settings for CANopen.

Object description

| | |
|------------------|---|
| Index | 2007 _h |
| Object name | CANopen Config |
| Object Code | ARRAY |
| Data type | UNSIGNED32 |
| Savable | yes, category: CANopen |
| Access | read only |
| PDO mapping | no |
| Allowed values | |
| Preset value | |
| Firmware version | FIR-v1540 |
| Change history | Firmware version FIR-v1748-B531667: "Savable" entry changed from "yes, category: communication" to "yes, category: CANopen". Firmware version FIR-v2412: Subindex 02 _h added. |

Value description

| | |
|----------------|-------------------|
| Subindex | 00 _h |
| Name | Number Of Entries |
| Data type | UNSIGNED8 |
| Access | read only |
| PDO mapping | no |
| Allowed values | |
| Preset value | 02 _h |

| | |
|----------------|-----------------------|
| Subindex | 01 _h |
| Name | BL Config |
| Data type | UNSIGNED32 |
| Access | read / write |
| PDO mapping | no |
| Allowed values | |
| Preset value | 00000000 _h |

| | |
|----------------|-----------------------|
| Subindex | 02 _h |
| Name | Automatic COB-ID |
| Data type | UNSIGNED32 |
| Access | read / write |
| PDO mapping | no |
| Allowed values | |
| Preset value | 00000001 _h |

Description

The subindices have the following functions:

- Subindex 01: If the value "1" is written in the object, the boot loader suppresses the boot-up message and only the firmware sends a BOOTUP message. With a "0", the boot loader and the firmware each send a BOOTUP message.
- Subindex 02: If the value is "1" (factory setting), the COB-ID for the PDOs 1 to 4 is entered automatically by the firmware. To set the COB-IDs manually and to save them, set the value to "0".

2009h CANopen NodeID

Function

This object contains the node-ID of the controller. See chapter *Commissioning*.

Object description

| | |
|------------------|--|
| Index | 2009 _h |
| Object name | CANopen NodeID |
| Object Code | VARIABLE |
| Data type | UNSIGNED8 |
| Savable | yes, category: CANopen |
| Access | read / write |
| PDO mapping | no |
| Allowed values | |
| Preset value | 7F _h |
| Firmware version | FIR-v1426 |
| Change history | Firmware version FIR-v1748-B531667: "Savable" entry changed from "yes, category: communication" to "yes, category: CANopen". |

2030h Pole Pair Count

Function

Contains the number of pole pairs of the connected motor.

Object description

| | |
|------------------|--|
| Index | 2030 _h |
| Object name | Pole Pair Count |
| Object Code | VARIABLE |
| Data type | UNSIGNED16 |
| Savable | yes, category: tuning |
| Access | read / write |
| PDO mapping | no |
| Allowed values | |
| Preset value | 0032 _h |
| Firmware version | FIR-v1426 |
| Change history | <p>Firmware version FIR-v1540: "Savable" entry changed from "no" to "yes, category: tuning".</p> <p>Firmware version FIR-v2315-B1040535: "Data type" entry changed from "UNSIGNED32" to "UNSIGNED16".</p> <p>Firmware version FIR-v2239-B1032745: "Datentyp" entry changed from "UNSIGNED16" to "UNSIGNED32".</p> <p>Firmware version FIR-v2339-B1048823: "Data type" entry changed from "UNSIGNED32" to "UNSIGNED16".</p> |

2031h Max Motor Current

Function

Enter the maximum permissible motor current in milliamperes here. All current values are limited by this value.

Within the controller, the entered value is always interpreted as the root mean square.

Object description

| | |
|------------------|-----------------------|
| Index | 2031 _h |
| Object name | Max Motor Current |
| Object Code | VARIABLE |
| Data type | UNSIGNED32 |
| Savable | yes, category: tuning |
| Access | read / write |
| PDO mapping | no |
| Allowed values | |
| Preset value | 00000000 _h |
| Firmware version | FIR-v1426 |

| | |
|----------------|---|
| Change history | Firmware version FIR-v1614: "Savable" entry changed from "yes, category: application" to "yes, category: tuning". |
| | Firmware version FIR-v1614: "Object Name" entry changed from "Peak Current" to "Max Current". |
| | Firmware version FIR-v1748-B538662: "Object Name" entry changed from "Maximum Current" to "Max Motor Current". |
| | Firmware version FIR-v1825-B577172: "Object Name" entry changed from "Max Motor Current" to "Maximum Current". |
| | Firmware version FIR-v1825-B577172: "Object Name" entry changed from "Maximum Current" to "Max Motor Current". |
| | Firmware version FIR-v1825-B577172: "Object Name" entry changed from "Max Motor Current" to "Maximum Current". |
| | Firmware version FIR-v1825-B577172: "Object Name" entry changed from "Maximum Current" to "Max Motor Current". |

2034h Upper Voltage Warning Level

Function

This object contains the threshold value for the "overvoltage" error in millivolts.

Object description

| | |
|------------------|-----------------------------|
| Index | 2034 _h |
| Object name | Upper Voltage Warning Level |
| Object Code | VARIABLE |
| Data type | UNSIGNED32 |
| Savable | yes, category: application |
| Access | read / write |
| PDO mapping | no |
| Allowed values | |
| Preset value | 00007D00 _h |
| Firmware version | FIR-v1426 |
| Change history | |

Description

If the input voltage of the controller exceeds this threshold value, the motor is switched off and an error triggered. This error is reset automatically if the input voltage is less than (voltage of object 2034_h minus 2 volts).

2035h Lower Voltage Warning Level

Function

This object contains the threshold value for the "Undervoltage" error in millivolts.

Object description

| | |
|------------------|-----------------------------|
| Index | 2035 _h |
| Object name | Lower Voltage Warning Level |
| Object Code | VARIABLE |
| Data type | UNSIGNED32 |
| Savable | yes, category: application |
| Access | read / write |
| PDO mapping | no |
| Allowed values | |
| Preset value | 00002904 _h |
| Firmware version | FIR-v1426 |
| Change history | |

Description

If the input voltage of the controller falls below this threshold value, the motor is switched off and an error triggered. The error is reset automatically if the input voltage exceeds the voltage of object 2035_h plus 1.5 volts.

2036h Open Loop Current Reduction Idle Time

Function

This object describes the time in milliseconds that the motor must be at a standstill before current reduction is activated.

Object description

| | |
|------------------|---------------------------------------|
| Index | 2036 _h |
| Object name | Open Loop Current Reduction Idle Time |
| Object Code | VARIABLE |
| Data type | UNSIGNED32 |
| Savable | yes, category: application |
| Access | read / write |
| PDO mapping | no |
| Allowed values | |
| Preset value | 000003E8 _h |
| Firmware version | FIR-v1426 |
| Change history | |

2037h Open Loop Current Reduction Value/factor

Function

This object describes the rms current to which the motor current in open-loop is to be reduced if the motor is at a standstill.

Object description

| | |
|------------------|--|
| Index | 2037 _h |
| Object name | Open Loop Current Reduction Value/factor |
| Object Code | VARIABLE |
| Data type | INTEGER32 |
| Savable | yes, category: application |
| Access | read / write |
| PDO mapping | no |
| Allowed values | |
| Preset value | FFFFFFCE _h |
| Firmware version | FIR-v1426 |
| Change history | |

Description

Value of 2037_h greater than or equal to 0 and less than value 6075_h

Current is reduced to the value entered here. The value is in mA and interpreted as root mean square.

Value of 2037_h in the range from -1 to -100

The entered value is interpreted as a percentage and determines the reduction of the rated current in 2037_h. The value in 6075_h is used for the calculation.

Example: Object 6075_h has the value 4200 mA. The value -60 in 2037_h reduces the current by 60% of 6075_h. The result is a current reduction to a root mean square of $\text{6075}_h * (\text{2037}_h + 100) / 100 = 1680$ mA.

The value -100 in 2037_h would, for example, mean that a current reduction is set to a root mean square of 0 mA.

2038h Brake Controller Timing

Function

This object contains the times for the *brake control* in milliseconds as well as the PWM frequency and the duty cycle.

Object description

| | |
|------------------|----------------------------|
| Index | 2038 _h |
| Object name | Brake Controller Timing |
| Object Code | ARRAY |
| Data type | UNSIGNED32 |
| Savable | yes, category: application |
| Firmware version | FIR-v1426 |
| Change history | |

Value description

| | |
|----------------|-------------------|
| Subindex | 00 _h |
| Name | Number Of Entries |
| Data type | UNSIGNED8 |
| Access | read only |
| PDO mapping | no |
| Allowed values | |
| Preset value | 06 _h |

| | |
|----------------|-----------------------|
| Subindex | 01 _h |
| Name | Close Brake Idle Time |
| Data type | UNSIGNED32 |
| Access | read / write |
| PDO mapping | no |
| Allowed values | |
| Preset value | 000003E8 _h |

| | |
|----------------|--------------------------|
| Subindex | 02 _h |
| Name | Shutdown Power Idle Time |
| Data type | UNSIGNED32 |
| Access | read / write |
| PDO mapping | no |
| Allowed values | |
| Preset value | 000003E8 _h |

| | |
|----------------|-----------------------|
| Subindex | 03 _h |
| Name | Open Brake Delay Time |
| Data type | UNSIGNED32 |
| Access | read / write |
| PDO mapping | no |
| Allowed values | |
| Preset value | 000003E8 _h |

| | |
|----------------|----------------------------|
| Subindex | 04 _h |
| Name | Start Operation Delay Time |
| Data type | UNSIGNED32 |
| Access | read / write |
| PDO mapping | no |
| Allowed values | |
| Preset value | 00000000 _h |

| | |
|----------|-----------------|
| Subindex | 05 _h |
|----------|-----------------|

| | |
|----------------|-----------------------|
| Name | PWM Frequency |
| Data type | UNSIGNED32 |
| Access | read / write |
| PDO mapping | no |
| Allowed values | between 50 and |
| Preset value | 00004E20 _h |

| | |
|----------------|---|
| Subindex | 06 _h |
| Name | PWM Duty Cycle |
| Data type | UNSIGNED32 |
| Access | read / write |
| PDO mapping | no |
| Allowed values | 0, between 2 and 100 (64 _h) |
| Preset value | 00000000 _h |

Description

The subindices have the following functions:

- 01_h: Time between motor standstill and the closing of the brake.
- 02_h: Time between the closing of the brake and the switching off of the motor current.
- 03_h: Time between the switching on of the motor current and opening of the brake.
- 04_h: Time between the opening of the brake and when the *Operation enabled* state of the CiA 402 Power State Machine is reached.
- 05_h: Frequency of the PWM signal in hertz.
- 06_h: Duty cycle of the PWM signal in percent.

2039h Motor Currents

Function

This object contains the measured motor currents in mA. All values are peak values, (#2*rms).

Object description

| | |
|------------------|---|
| Index | 2039 _h |
| Object name | Motor Currents |
| Object Code | ARRAY |
| Data type | INTEGER32 |
| Savable | no |
| Access | read only |
| PDO mapping | no |
| Allowed values | |
| Preset value | |
| Firmware version | FIR-v1426 |
| Change history | <p>Firmware version FIR-v1504: "PDO mapping" table entry for subindex 01 changed from "no" to "TX-PDO".</p> <p>Firmware version FIR-v1504: "PDO mapping" table entry for subindex 02 changed from "no" to "TX-PDO".</p> |

Firmware version FIR-v1504: "PDO mapping" table entry for subindex 03 changed from "no" to "TX-PDO".

Firmware version FIR-v1504: "PDO mapping" table entry for subindex 04 changed from "no" to "TX-PDO".

Firmware version FIR-v2213: subindex 05_h, "Actual Current" added. Phase currents I_a and I_b changed to I_α and I_β (Clarke transformation).

Value description

| | |
|----------------|-----------------------|
| Subindex | 00 _h |
| Name | Number Of Entries |
| Data type | UNSIGNED8 |
| Access | read only |
| PDO mapping | no |
| Allowed values | |
| Preset value | 05 _h |
| Subindex | 01 _h |
| Name | Id |
| Data type | INTEGER32 |
| Access | read only |
| PDO mapping | TX-PDO |
| Allowed values | |
| Preset value | 00000000 _h |
| Subindex | 02 _h |
| Name | I _q |
| Data type | INTEGER32 |
| Access | read only |
| PDO mapping | TX-PDO |
| Allowed values | |
| Preset value | 00000000 _h |
| Subindex | 03 _h |
| Name | I _α |
| Data type | INTEGER32 |
| Access | read only |
| PDO mapping | TX-PDO |
| Allowed values | |
| Preset value | 00000000 _h |
| Subindex | 04 _h |
| Name | I _β |

| | |
|----------------|-----------------------|
| Data type | INTEGER32 |
| Access | read only |
| PDO mapping | TX-PDO |
| Allowed values | |
| Preset value | 00000000 _h |

| | |
|----------------|-----------------------|
| Subindex | 05 _h |
| Name | Actual Current |
| Data type | INTEGER32 |
| Access | read only |
| PDO mapping | TX-PDO |
| Allowed values | |
| Preset value | 00000000 _h |

Description

- 01_h: Field-forming components of the current
- 02_h: Torque-forming components of the current
- 03_h: I_α
- 04_h: I_β
- 05_h: total current divided by $\sqrt{2}$, i.e., calculated down to a motor phase. In *closed-loop*, the sign of I_q is also used. The current value can then be placed on a scale to compare with the current from 6075_h, 2031_h and 203B_h:05_h.
open-loop: $I = \sqrt{(I_\alpha^2 + I_\beta^2)} / \sqrt{2}$
Closed Loop: $I = \text{sgn}(I_q) * \sqrt{(I_\alpha^2 + I_\beta^2)} / \sqrt{2}$

NOTICE



Motor currents I_d (subindex 01_h) and I_q (subindex 02_h) are only displayed if closed-loop was activated; the value 0 is otherwise output.

203Ah Homing On Block Configuration

Function

This object contains the parameters for *Homing on Block* (see chapter [Homing](#)).

Object description

| | |
|------------------|-------------------------------|
| Index | 203A _h |
| Object name | Homing On Block Configuration |
| Object Code | ARRAY |
| Data type | INTEGER32 |
| Savable | yes, category: application |
| Access | |
| PDO mapping | |
| Allowed values | |
| Preset value | |
| Firmware version | FIR-v1426 |

| | |
|----------------|---|
| Change history | Firmware version FIR-v1540: The number of entries was changed from 4 to 3. |
| | Firmware version FIR-v1540: "Name" entry changed from "Period Of Blocking" to "Block Detection time". |
| | Firmware version FIR-v1614: "Data Type" entry changed from "UNSIGNED32" to "INTEGER32". |
| | Firmware version FIR-v1614: "Savable" entry changed from "no" to "yes, category: application". |
| | Firmware version FIR-v1614: "Data Type" entry changed from "UNSIGNED32" to "INTEGER32". |
| | Firmware version FIR-v1614: "Data Type" entry changed from "UNSIGNED32" to "INTEGER32". |

Value description

| | |
|----------------|-------------------------------------|
| Subindex | 00 _h |
| Name | Number Of Entries |
| Data type | UNSIGNED8 |
| Access | read only |
| PDO mapping | no |
| Allowed values | |
| Preset value | 02 _h |
| Subindex | 01 _h |
| Name | Minimum Current For Block Detection |
| Data type | INTEGER32 |
| Access | read / write |
| PDO mapping | no |
| Allowed values | |
| Preset value | FFFFFFBA _h |
| Subindex | 02 _h |
| Name | Block Detection Time |
| Data type | INTEGER32 |
| Access | read / write |
| PDO mapping | no |
| Allowed values | |
| Preset value | 000000C8 _h |

Description

The subindices have the following function:

- 01_h: Specifies the current limit value above which blocking is to be detected. Positive numerical values specify the current limit in mA, negative numbers specify a percentage of object 2031_h. Example: The value "1000" corresponds to 1000 mA (= 1 A); the value "-70" corresponds to 70% of 2031_h.

- 02_h: Specifies the time in ms that the motor is to continue to travel against the block after block detection.

203B_h I²t Parameters

Function

This object contains the parameters for I²t monitoring.

I²t monitoring is activated by entering a value greater than 0 in 203B_h:01 and 203B_h:02 and a value greater than 1000 in 6073_h (see [I²t Motor overload protection](#)).

With one exception, I²t monitoring can only be used for *closed-loop* mode: If I²t is activated in *open-loop* mode, the current is reduced to the smaller of 203B_h:01_h, 6073_h and 2031_h.

Object description

| | |
|------------------|---|
| Index | 203B _h |
| Object name | I ² t Parameters |
| Object Code | ARRAY |
| Data type | UNSIGNED32 |
| Savable | yes, category: tuning |
| Firmware version | FIR-v1426 |
| Change history | <p>Firmware version FIR-v1512: "Savable" entry changed from "no" to "yes, category: application".</p> <p>Firmware version FIR-v1512: The number of entries was changed from 7 to 8.</p> <p>Firmware version FIR-v1614: "Savable" entry changed from "yes, category: application" to "yes, category: tuning".</p> <p>Firmware version FIR-v1748-B538662: "Name" entry changed from "Nominal Current" to "Motor Rated Current".</p> <p>Firmware version FIR-v1825-B577172: "Name" entry changed from "Motor Rated Current" to "Nominal Current".</p> <p>Firmware version FIR-v1825-B577172: "Name" entry changed from "Nominal Current" to "Motor Rated Current".</p> <p>Firmware version FIR-v1825-B577172: "Name" entry changed from "Motor Rated Current" to "Nominal Current".</p> <p>Firmware version FIR-v1825-B577172: "Name" entry changed from "Nominal Current" to "Motor Rated Current".</p> <p>Firmware version FIR-v1825-B577172: The number of entries was changed from 8 to 7.</p> <p>Firmware version FIR-v1926-B648637: "Name" entry changed from "Maximum Duration Of Peak Current" to "Maximum Duration Of Max Current".</p> |

Value description

| | |
|-----------|-------------------|
| Subindex | 00 _h |
| Name | Number Of Entries |
| Data type | UNSIGNED8 |
| Access | read only |

| | |
|----------------|---------------------------------|
| PDO mapping | no |
| Allowed values | |
| Preset value | 06 _h |
| <hr/> | |
| Subindex | 01 _h |
| Name | Motor Rated Current |
| Data type | UNSIGNED32 |
| Access | read / write |
| PDO mapping | no |
| Allowed values | |
| Preset value | 00000000 _h |
| <hr/> | |
| Subindex | 02 _h |
| Name | Maximum Duration Of Max Current |
| Data type | UNSIGNED32 |
| Access | read / write |
| PDO mapping | no |
| Allowed values | |
| Preset value | 000003E8 _h |
| <hr/> | |
| Subindex | 03 _h |
| Name | Threshold |
| Data type | UNSIGNED32 |
| Access | read / write |
| PDO mapping | no |
| Allowed values | |
| Preset value | 00000000 _h |
| <hr/> | |
| Subindex | 04 _h |
| Name | Calculated Value |
| Data type | UNSIGNED32 |
| Access | read / write |
| PDO mapping | no |
| Allowed values | |
| Preset value | 00000000 _h |
| <hr/> | |
| Subindex | 05 _h |
| Name | Limited Current |
| Data type | UNSIGNED32 |
| Access | read / write |
| PDO mapping | no |
| Allowed values | |
| Preset value | 00000000 _h |

| | |
|----------------|-----------------------|
| Subindex | 06 _h |
| Name | Status |
| Data type | UNSIGNED32 |
| Access | read / write |
| PDO mapping | no |
| Allowed values | |
| Preset value | 00000000 _h |

Description

The subindices are divided into two groups: subindex 01_h and 02_h contain parameters for control, subindices 03_h to 06_h are status values. The functions are as follows:

- 01_h: The rated current specified in the motor data sheet is entered here in mA. This must be smaller than the current entered in 2031_h and 6073_h, otherwise monitoring is not activated. The specified value is interpreted as root mean square.
- 02_h: Specifies the maximum duration of the maximum current (6073_h) in ms.
- 03_h: Threshold, specifies the limit in A²ms that determines whether the maximum current or rated current is switched to.
- 04_h: CalcValue, specifies the calculated value in A²ms that is compared with the threshold for setting the current.
- 05_h: LimitedCurrent, contains the momentary current as root mean square set by I²t.
- 06_h: Current status. If the sub-entry value is "0", I²t is deactivated; if the value is "1", I²t is activated.

203Dh Torque Window

Function

Specifies a symmetrical range relative to the target torque within which the target is considered having been met.

If the value is set to "FFFFFFF"_h, monitoring is switched off, the "Target reached" bit in object 6041_h (statusword) is never set.

Object description

| | |
|------------------|--|
| Index | 203D _h |
| Object name | Torque Window |
| Object Code | VARIABLE |
| Data type | UNSIGNED16 |
| Savable | yes, category: application |
| Access | read / write |
| PDO mapping | RX-PDO |
| Allowed values | |
| Preset value | 0000 _h |
| Firmware version | FIR-v1540 |
| Change history | Firmware version FIR-v1614: "Savable" entry changed from "no" to "yes, category: application". |

203Eh Torque Window Time Out

Function

The current torque must be within the "Torque Window" (203D_h) for this time (in milliseconds) for the target torque to be considered having been met.

Object description

| | |
|------------------|---|
| Index | 203E _h |
| Object name | Torque Window Time Out |
| Object Code | VARIABLE |
| Data type | UNSIGNED16 |
| Savable | yes, category: application |
| Access | read / write |
| PDO mapping | RX-PDO |
| Allowed values | |
| Preset value | 0000 _h |
| Firmware version | FIR-v1540 |
| Change history | <p>Firmware version FIR-v1614: "Savable" entry changed from "no" to "yes, category: application".</p> <p>Firmware version FIR-v1738-B501312: "Object Name" entry changed from "Torque Window Time" to "Torque Window Time Out".</p> |

203Fh Max Slippage Time Out

Function

Time in milliseconds until an excessively large slippage error in Profile Velocity mode results in an error message.

Object description

| | |
|------------------|----------------------------|
| Index | 203F _h |
| Object name | Max Slippage Time Out |
| Object Code | VARIABLE |
| Data type | UNSIGNED16 |
| Savable | yes, category: application |
| Access | read / write |
| PDO mapping | RX-PDO |
| Allowed values | |
| Preset value | 0064 _h |
| Firmware version | FIR-v1738-B501312 |
| Change history | |

Description

If the actual speed deviates so much from the set speed that the value (absolute value) of the object `60F8h` (Max Slippage) is exceeded, bit 13 in object `6041h` is set. The deviation must last longer than the time in object `203Fh`.

A reaction to the slippage error can be set in object `3700h`. If a reaction is defined, an error is also entered in object `1003h`.

2057h Clock Direction Multiplier

Function

The clock count value in Clock-direction mode is multiplied by this value before it is processed further.

Object description

| | |
|------------------|--|
| Index | 2057 _h |
| Object name | Clock Direction Multiplier |
| Object Code | VARIABLE |
| Data type | UNSIGNED32 |
| Savable | yes, category: application |
| Access | read / write |
| PDO mapping | no |
| Allowed values | |
| Preset value | 00000080 _h |
| Firmware version | FIR-v1426 |
| Change history | Firmware version FIR-v2339-B1048823: "Data type" entry changed from "INTEGER32" to "UNSIGNED32". |

2058h Clock Direction Divider

Function

The clock count value in Clock-direction mode is divided by this value before it is processed further.

Object description

| | |
|------------------|--|
| Index | 2058 _h |
| Object name | Clock Direction Divider |
| Object Code | VARIABLE |
| Data type | UNSIGNED32 |
| Savable | yes, category: application |
| Access | read / write |
| PDO mapping | no |
| Allowed values | |
| Preset value | 00000001 _h |
| Firmware version | FIR-v1426 |
| Change history | Firmware version FIR-v2339-B1048823: "Data type" entry changed from "INTEGER32" to "UNSIGNED32". |

205Ah Absolute Sensor Boot Value (in User Units)

Function

The initial encoder position when switching on the controller (in user-defined units) can be read from this object.

Object description

| | |
|------------------|--|
| Index | 205A _h |
| Object name | Absolute Sensor Boot Value (in User Units) |
| Object Code | VARIABLE |
| Data type | INTEGER32 |
| Savable | no |
| Access | read only |
| PDO mapping | no |
| Allowed values | |
| Preset value | 00000000 _h |
| Firmware version | FIR-v1446 |
| Change history | <p>Firmware version FIR-v1512: "Access" table entry for subindex 00 changed from "read/write" to "read only".</p> <p>Firmware version FIR-v1738-B501312: "Object Name" entry changed from "Encoder Boot Value" to "Absolute Sensor Boot Value (in User Units)".</p> <p>Firmware version FIR-v1738-B501312: "Data type" entry changed from "UNSIGNED32" to "INTEGER32".</p> |

205Bh Clock Direction Or Clockwise/Counter Clockwise Mode

Function

This object can be used to switch the clock-direction mode (value = "0") to the right/left rotation mode (value = "1").

Object description

| | |
|------------------|---|
| Index | 205B _h |
| Object name | Clock Direction Or Clockwise/Counter Clockwise Mode |
| Object Code | VARIABLE |
| Data type | UNSIGNED32 |
| Savable | yes, category: application |
| Access | read / write |
| PDO mapping | no |
| Allowed values | |
| Preset value | 00000000 _h |
| Firmware version | FIR-v1504 |
| Change history | |

2084h Bootup Delay

Function

Defines the period between the time that supply voltage is applied to the controller and the functional readiness of the controller in milliseconds.

Object description

| | |
|------------------|----------------------------|
| Index | 2084 _h |
| Object name | Bootup Delay |
| Object Code | VARIABLE |
| Data type | UNSIGNED32 |
| Savable | yes, category: application |
| Access | read / write |
| PDO mapping | no |
| Allowed values | |
| Preset value | 00000000 _h |
| Firmware version | FIR-v1426 |
| Change history | |

2101h Fieldbus Module Availability

Function

Shows the available fieldbuses.

Object description

| | |
|------------------|--|
| Index | 2101 _h |
| Object name | Fieldbus Module Availability |
| Object Code | VARIABLE |
| Data type | UNSIGNED32 |
| Savable | no |
| Access | read only |
| PDO mapping | no |
| Allowed values | |
| Preset value | <ul style="list-style-type: none"> ■ PD1-C281S15-E-20-2: 00000008_h ■ PD1-C281S15-E-20-5: 00010002_h ■ PD1-C281S15-E-65-2: 00000008_h ■ PD1-C281S15-E-65-5: 00010002_h ■ PD1-C281S15-E-OF-2: 00000008_h ■ PD1-C281S15-E-OF-5: 00010002_h ■ PD1-C281L15-E-20-2: 00000008_h ■ PD1-C281L15-E-20-5: 00010002_h ■ PD1-C281L15-E-65-2: 00000008_h ■ PD1-C281L15-E-65-5: 00010002_h ■ PD1-C281L15-E-OF-2: 00000008_h ■ PD1-C281L15-E-OF-5: 00010002_h |
| Firmware version | FIR-v1426 |

Change history

 Firmware version FIR-v1626: "Object Name" entry changed from "Fieldbus Module" to "Fieldbus Module Availability".

Description

Bits 0 to 15 represent the physical interface, bits 16 to 31 the used protocol (if necessary).

| | | | | | | | | | | | | | | | |
|----|----|----|----|----|----|----|----|----|-----|-------|-------|-----|-------|-------|------|
| 31 | 30 | 29 | 28 | 27 | 26 | 25 | 24 | 23 | 22 | 21 | 20 | 19 | 18 | 17 | 16 |
| | | | | | | | | | | | | | E-IP | MTCP | MRTU |
| 15 | 14 | 13 | 12 | 11 | 10 | 9 | 8 | 7 | 6 | 5 | 4 | 3 | 2 | 1 | 0 |
| | | | | | | | | | SPI | E-CAT | E-NET | CAN | RS232 | RS485 | USB |

USB

Value = "1": The USB fieldbus is available.

RS-485

Value = "1": An RS-485 interface is available.

RS-232

Value = "1": An RS-232 interface is available.

CAN

Value = "1": The CANopen fieldbus is available.

E-NET

Value = "1": An Ethernet interface is available.

E-CAT

Value = "1": An EtherCAT interface is available.

SPI

Value = "1": An SPI interface is available.

MRTU

Value = "1": The used protocol is Modbus RTU.

MTCP

Value = "1": The used protocol is Modbus TCP

E-IP

Value = "1": The used protocol is EtherNet/IP™

2102h Fieldbus Module Control

Function

This object can be used to activate/deactivate certain fieldbuses (physical interfaces and protocols).

Object description

| | |
|-------------|-------------------------|
| Index | 2102 _h |
| Object name | Fieldbus Module Control |
| Object Code | VARIABLE |
| Data type | UNSIGNED32 |

| | |
|------------------|--|
| Savable | yes, category: communication |
| Access | read / write |
| PDO mapping | no |
| Allowed values | |
| Preset value | <ul style="list-style-type: none"> ■ PD1-C281S15-E-20-2: 00000008_h ■ PD1-C281S15-E-20-5: 00010002_h ■ PD1-C281S15-E-65-2: 00000008_h ■ PD1-C281S15-E-65-5: 00010002_h ■ PD1-C281S15-E-OF-2: 00000008_h ■ PD1-C281S15-E-OF-5: 00010002_h ■ PD1-C281L15-E-20-2: 00000008_h ■ PD1-C281L15-E-20-5: 00010002_h ■ PD1-C281L15-E-65-2: 00000008_h ■ PD1-C281L15-E-65-5: 00010002_h ■ PD1-C281L15-E-OF-2: 00000008_h ■ PD1-C281L15-E-OF-5: 00010002_h |
| Firmware version | FIR-v1540 |
| Change history | Firmware version FIR-v1626: "Savable" entry changed from "yes, category: application" to "yes, category: communication". |

Description

Object 2103_h:1_h contains all physical interfaces/protocols that can be activated/deactivated. These can be switched in this object (2102_h). The current status of the activated fieldbuses is in object 2103_h:2_h.

The following distribution of the bits applies here:

| | | | | | | | | | | | | | | | |
|----|----|----|----|----|----|----|----|----|-----|-------|-------|-----|-------|-------|------|
| 31 | 30 | 29 | 28 | 27 | 26 | 25 | 24 | 23 | 22 | 21 | 20 | 19 | 18 | 17 | 16 |
| | | | | | | | | | | | | | E-IP | MTCP | MRTU |
| 15 | 14 | 13 | 12 | 11 | 10 | 9 | 8 | 7 | 6 | 5 | 4 | 3 | 2 | 1 | 0 |
| | | | | | | | | | SPI | E-CAT | E-NET | CAN | RS232 | RS485 | USB |

USB

USB interface

RS-485

RS-485 interface

RS-232

RS-232 interface

CAN

CANopen interface

E-NET

EtherNet interface

E-CAT

EtherCAT interface

SPI

SPI interface

MRTU

Modbus RTU protocol

MTCP

Modbus TCP protocol

E-IP

EtherNet/IP™ protocol

2103h Fieldbus Module Status**Function**

Shows the active fieldbuses.

Object description

| | |
|------------------|------------------------|
| Index | 2103 _h |
| Object name | Fieldbus Module Status |
| Object Code | ARRAY |
| Data type | UNSIGNED32 |
| Savable | no |
| Access | read only |
| PDO mapping | no |
| Allowed values | |
| Preset value | |
| Firmware version | FIR-v1540 |
| Change history | |

Value description

| | |
|----------------|-------------------|
| Subindex | 00 _h |
| Name | Number Of Entries |
| Data type | UNSIGNED8 |
| Access | read only |
| PDO mapping | no |
| Allowed values | |
| Preset value | 02 _h |

| | |
|----------------|--|
| Subindex | 01 _h |
| Name | Fieldbus Module Disable Mask |
| Data type | UNSIGNED32 |
| Access | read only |
| PDO mapping | no |
| Allowed values | |
| Preset value | <ul style="list-style-type: none"> ■ PD1-C281S15-E-20-2: 00000008_h ■ PD1-C281S15-E-20-5: 00010002_h ■ PD1-C281S15-E-65-2: 00000008_h |

- PD1-C281S15-E-65-5: 00010002_h
- PD1-C281S15-E-OF-2: 00000008_h
- PD1-C281S15-E-OF-5: 00010002_h
- PD1-C281L15-E-20-2: 00000008_h
- PD1-C281L15-E-20-5: 00010002_h
- PD1-C281L15-E-65-2: 00000008_h
- PD1-C281L15-E-65-5: 00010002_h
- PD1-C281L15-E-OF-2: 00000008_h
- PD1-C281L15-E-OF-5: 00010002_h

| | |
|----------------|-------------------------|
| Subindex | 02 _h |
| Name | Fieldbus Module Enabled |
| Data type | UNSIGNED32 |
| Access | read only |
| PDO mapping | no |
| Allowed values | |
| Preset value | 00000000 _h |

Description

Subindex 1 (Fieldbus Module Disable Mask): This subindex contains all physical interfaces and protocols that can be activated or deactivated. The set bit means that this fieldbus can be deactivated.

Subindex 2 (Fieldbus Module Enabled): This subindex contains all currently activated physical interfaces and protocols. The set bit means that the fieldbus is active.

The following distribution of the bits applies for subindices 1 and 2:

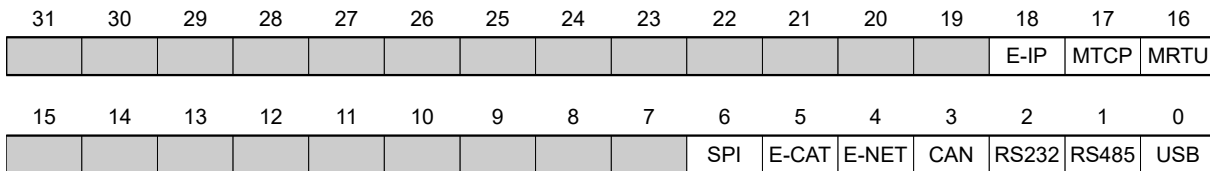

USB

USB interface

RS-485

RS-485 interface

RS-232

RS-232 interface

CAN

CANopen interface

E-NET

EtherNet interface

E-CAT

EtherCAT interface

SPI

SPI interface

MRTU

Modbus RTU protocol

MTCP

Modbus TCP protocol

E-IP

EtherNet/IP™ protocol

2290h PDI Control**Function**

With this object, you can activate the *Plug&Drive interface*. You can find additional information in document *Function description Plug&Drive interface*.

Object description

| | |
|------------------|--|
| Index | 2290 _h |
| Object name | PDI Control |
| Object Code | VARIABLE |
| Data type | UNSIGNED8 |
| Savable | yes, category: application |
| Access | read / write |
| PDO mapping | no |
| Allowed values | |
| Preset value | 01 _h |
| Firmware version | FIR-v1748-B531667 |
| Change history | Firmware version FIR-v1748-B538662: "Access" table entry for subindex 00 changed from "read only" to "read/write". |

Description

To activate the *Plug&Drive interface*, set bit 0 to "1".

2291h PDI Input**Function**

If you use the *Plug&Drive interface*, you can use this object to select and start the operating mode and set the corresponding target values (target position, speed, etc.). You can find additional information in document *Function description Plug&Drive interface*.

Object description

| | |
|-------------|-------------------|
| Index | 2291 _h |
| Object name | PDI Input |
| Object Code | RECORD |
| Data type | PDI_INPUT |

| | |
|------------------|---|
| Savable | no |
| Access | read only |
| PDO mapping | RX-PDO |
| Allowed values | |
| Preset value | |
| Firmware version | FIR-v1748-B531667 |
| Change history | <p>Firmware version FIR-v2013-B726332: "Savable" entry changed from "yes, category: application" to "no".</p> <p>Firmware version FIR-v2315-B1040535: "Data type" entry changed from "INTEGER8" to "UNSIGNED8".</p> |

Value description

| | |
|----------------|-------------------|
| Subindex | 00 _h |
| Name | Number Of Entries |
| Data type | UNSIGNED8 |
| Access | read only |
| PDO mapping | RX-PDO |
| Allowed values | |
| Preset value | 04 _h |

| | |
|----------------|-----------------------|
| Subindex | 01 _h |
| Name | PDI Set Value 1 |
| Data type | INTEGER32 |
| Access | read / write |
| PDO mapping | RX-PDO |
| Allowed values | |
| Preset value | 00000000 _h |

| | |
|----------------|-------------------|
| Subindex | 02 _h |
| Name | PDI Set Value 2 |
| Data type | INTEGER16 |
| Access | read / write |
| PDO mapping | RX-PDO |
| Allowed values | |
| Preset value | 0000 _h |

| | |
|----------------|-----------------|
| Subindex | 03 _h |
| Name | PDI Set Value 3 |
| Data type | INTEGER8 |
| Access | read / write |
| PDO mapping | RX-PDO |
| Allowed values | |
| Preset value | 00 _h |

| | |
|----------------|-----------------|
| Subindex | 04 _h |
| Name | PDI Command |
| Data type | UNSIGNED8 |
| Access | read / write |
| PDO mapping | RX-PDO |
| Allowed values | |
| Preset value | 00 _h |

2292h PDI Output

Function

If you use the *Plug&Drive interface*, you can, in this object, read the status and a return value that is dependent on the used operating mode. You can find additional information in document *Function description Plug&Drive interface*.

Object description

| | |
|------------------|--|
| Index | 2292 _h |
| Object name | PDI Output |
| Object Code | RECORD |
| Data type | PDI_OUTPUT |
| Savable | no |
| Access | read only |
| PDO mapping | TX-PDO |
| Allowed values | |
| Preset value | |
| Firmware version | FIR-v1748-B531667 |
| Change history | Firmware version FIR-v2315-B1040535: "Data type" entry changed from "INTEGER16" to "UNSIGNED16". |

Value description

| | |
|----------------|-------------------|
| Subindex | 00 _h |
| Name | Number Of Entries |
| Data type | UNSIGNED8 |
| Access | read only |
| PDO mapping | TX-PDO |
| Allowed values | |
| Preset value | 02 _h |

| | |
|-------------|-----------------|
| Subindex | 01 _h |
| Name | PDI Status |
| Data type | UNSIGNED16 |
| Access | read only |
| PDO mapping | TX-PDO |

| | |
|----------------|-----------------------|
| Allowed values | |
| Preset value | 0000 _h |
| <hr/> | |
| Subindex | 02 _h |
| Name | PDI Return Value |
| Data type | INTEGER32 |
| Access | read only |
| PDO mapping | TX-PDO |
| Allowed values | |
| Preset value | 00000000 _h |

2300h NanoJ Control

Function

Controls the execution of a *NanoJ program*.

Object description

| | |
|------------------|--|
| Index | 2300 _h |
| Object name | NanoJ Control |
| Object Code | VARIABLE |
| Data type | UNSIGNED32 |
| Savable | yes, category: application |
| Access | read / write |
| PDO mapping | RX-PDO |
| Allowed values | |
| Preset value | 00000000 _h |
| Firmware version | FIR-v1426 |
| Change history | Firmware version FIR-v1436: "Object Name" entry changed from "VMM Control" to "NanoJ Control". |

Description

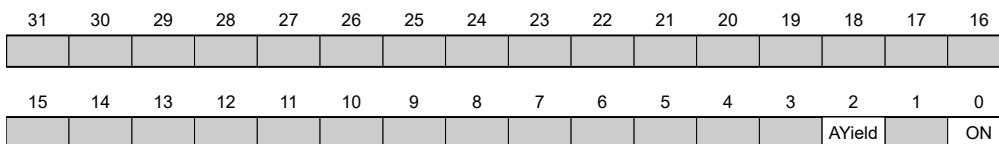

ON

Switches the *NanoJ program* on (value = "1") or off (value = "0").

With a rising edge in bit 0, the program is first reloaded and the variable range reset.



NOTICE

Startup of the *NanoJ program* can take up to 200 ms.

When switching on, a check is performed to determine whether a *NanoJ program* is present. If present, "1" is entered in 2300 and the *NanoJ program* is started.

AYield (AutoYield)

If this feature is activated (bit set to "1"), the *NanoJ program* is no longer stopped if it runs longer than it is allowed to. The *NanoJ program* is, thus, no longer real-time capable and no longer runs every 1 ms (see [Available computing time](#)).



NOTICE

Do not use the [Debug output](#) if *AutoYield* mode is activated.

2301h NanoJ Status

Function

Indicates the operating state of the user program.

Object description

| | |
|------------------|--|
| Index | 2301 _h |
| Object name | NanoJ Status |
| Object Code | VARIABLE |
| Data type | UNSIGNED32 |
| Savable | no |
| Access | read only |
| PDO mapping | TX-PDO |
| Allowed values | |
| Preset value | 00000000 _h |
| Firmware version | FIR-v1426 |
| Change history | Firmware version FIR-v1436: "Object Name" entry changed from "VMM Status" to "NanoJ Status". |

Description

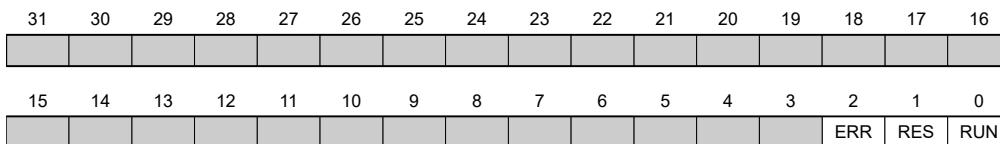

RUN

Value = "0": Program is stopped, value = "1": NanoJ program is running.

RES

Reserved.

ERR

Program was ended with an error. Cause of the error can be read from object [2302_h](#).

2302_h NanoJ Error Code**Function**

Indicates which error occurred during the execution of the user program.

Object description

| | |
|------------------|--|
| Index | 2302 _h |
| Object name | NanoJ Error Code |
| Object Code | VARIABLE |
| Data type | UNSIGNED32 |
| Savable | no |
| Access | read only |
| PDO mapping | TX-PDO |
| Allowed values | |
| Preset value | 00000000 _h |
| Firmware version | FIR-v1426 |
| Change history | Firmware version FIR-v1436: "Object Name" entry changed from "VMM Error Code" to "NanoJ Error Code". |

Description

Error codes during program execution:

| Number | Description |
|-------------------|--|
| 0001 _h | Firmware does not support the used function (e.g., <i>sin</i> , <i>cos</i> , etc.) |
| 0002 _h | Error in memory management |
| 0005 _h | Time Out: Code executed too long without <i>yield()</i> or <i>sleep()</i> |
| 0100 _h | Invalid NanoJ program file |
| 0102 _h | CRC error in the NanoJ program file |

Error when accessing an object:

| Number | Description |
|--|--|
| 1xxxxyy _h | Invalid mapping in the NanoJ program file: The value in "xxxx" specifies the index, the value in "yy" specifies the subindex of the object that should – but cannot – be mapped. |
| 2000000 _h + number of surplus variables | Invalid mapping in the NanoJ program file: too many variables of type <i>input</i> were declared (see 2310_h NanoJ Input Data Selection) |
| 3000000 _h + number of surplus variables | Invalid mapping in the NanoJ program file: too many variables of type <i>output</i> were declared (see 2320_h NanoJ Output Data Selection) |
| 4000000 _h + number of surplus variables | Invalid mapping in the NanoJ program file: too many variables of type <i>inout</i> were declared (see 2330_h NanoJ In/output Data Selection) |
| 1000 _h | Access of a nonexistent object in the object dictionary |

| Number | Description |
|-------------------|--|
| 1001 _h | Write access of a write-protected entry in the OD |
| 1002 _h | An attempt was made to write a value that is too low or too high to an object. |
| 1003 _h | An attempt was made to read out an object that permits only write access. |
| 1FFF _h | Unauthorized access of an object |

2303h NanoJ Metadata

Function

This object is used to correctly recognize the NanoJ program by external software, e.g., *Plug & Drive Studio*.

Object description

| | |
|------------------|--------------------|
| Index | 2303 _h |
| Object name | NanoJ Metadata |
| Object Code | ARRAY |
| Data type | UNSIGNED32 |
| Savable | no |
| Access | read only |
| PDO mapping | no |
| Allowed values | |
| Preset value | |
| Firmware version | FIR-v2339-B1048823 |
| Change history | |

Value description

| | |
|----------------|-------------------|
| Subindex | 00 _h |
| Name | Number Of Entries |
| Data type | UNSIGNED8 |
| Access | read only |
| PDO mapping | no |
| Allowed values | |
| Preset value | 06 _h |

| | |
|----------------|-----------------------|
| Subindex | 01 _h |
| Name | Version |
| Data type | UNSIGNED32 |
| Access | read only |
| PDO mapping | no |
| Allowed values | |
| Preset value | 00000300 _h |

| | |
|----------|-----------------|
| Subindex | 02 _h |
|----------|-----------------|

| | |
|----------------|-----------------------|
| Name | FLASH Start Address |
| Data type | UNSIGNED32 |
| Access | read only |
| PDO mapping | no |
| Allowed values | |
| Preset value | 00000000 _h |

| | |
|----------------|-----------------------|
| Subindex | 03 _h |
| Name | FLASH End Address |
| Data type | UNSIGNED32 |
| Access | read only |
| PDO mapping | no |
| Allowed values | |
| Preset value | 00000000 _h |

| | |
|----------------|-----------------------|
| Subindex | 04 _h |
| Name | RAM Start Address |
| Data type | UNSIGNED32 |
| Access | read only |
| PDO mapping | no |
| Allowed values | |
| Preset value | 00000000 _h |

| | |
|----------------|-----------------------|
| Subindex | 05 _h |
| Name | RAM End Address |
| Data type | UNSIGNED32 |
| Access | read only |
| PDO mapping | no |
| Allowed values | |
| Preset value | 00000000 _h |

| | |
|----------------|-----------------------|
| Subindex | 06 _h |
| Name | Header Size |
| Data type | UNSIGNED32 |
| Access | read only |
| PDO mapping | no |
| Allowed values | |
| Preset value | 00000000 _h |

230Eh Timer

Function

This object contains the operating time in milliseconds since the last time the controller was started.

NOTICE

This object is not stored; counting begins with "0" again after switching on or an overflow.

Object description

| | |
|------------------|--------------------|
| Index | 230E _h |
| Object name | Timer |
| Object Code | ARRAY |
| Data type | UNSIGNED32 |
| Savable | no |
| Access | read only |
| PDO mapping | no |
| Allowed values | |
| Preset value | |
| Firmware version | FIR-v2139-B1020888 |
| Change history | |

Value description

| | |
|----------------|-------------------|
| Subindex | 00 _h |
| Name | Number Of Entries |
| Data type | UNSIGNED8 |
| Access | read only |
| PDO mapping | no |
| Allowed values | |
| Preset value | 01 _h |

| | |
|----------------|-----------------------|
| Subindex | 01 _h |
| Name | 1ms Timer |
| Data type | UNSIGNED32 |
| Access | read only |
| PDO mapping | no |
| Allowed values | |
| Preset value | 00000000 _h |

230Fh Uptime Seconds

Function

This object contains the operating time in seconds since the last time the controller was started.

NOTICE

This object is not stored; counting begins with "0" again after switching on or an overflow.

Object description

| | |
|------------------|-----------------------|
| Index | 230F _h |
| Object name | Uptime Seconds |
| Object Code | VARIABLE |
| Data type | UNSIGNED32 |
| Savable | no |
| Access | read only |
| PDO mapping | TX-PDO |
| Allowed values | |
| Preset value | 00000000 _h |
| Firmware version | FIR-v1436 |
| Change history | |

2310h NanoJ Input Data Selection

Function

Describes the object dictionary entries that are copied to the PDO mapping input of the NanoJ program.

Object description

| | |
|------------------|---|
| Index | 2310 _h |
| Object name | NanoJ Input Data Selection |
| Object Code | ARRAY |
| Data type | UNSIGNED32 |
| Savable | no |
| Access | read / write |
| PDO mapping | no |
| Allowed values | |
| Preset value | |
| Firmware version | FIR-v1650-B472161 |
| Change history | <p>Firmware version FIR-v1436: "Object Name" entry changed from "VMM Input Data Selection" to "NanoJ Input Data Selection".</p> <p>Firmware version FIR-v1650-B472161: "Savable" entry changed from "yes, category: application" to "no".</p> <p>Firmware version FIR-v1650-B472161: "Access" table entry for subindex 00 changed from "read/write" to "read only".</p> <p>Firmware version FIR-v1650-B472161: "Access" table entry for subindex 01 changed from "read/write" to "read only".</p> |

Value description

| | |
|-----------|-------------------|
| Subindex | 00 _h |
| Name | Number Of Entries |
| Data type | UNSIGNED8 |
| Access | read only |

| | |
|----------------|-----------------------------------|
| PDO mapping | no |
| Allowed values | |
| Preset value | 10 _h |
| <hr/> | |
| Subindex | 01 _h - 10 _h |
| Name | Mapping #1 - #16 |
| Data type | UNSIGNED32 |
| Access | read only |
| PDO mapping | no |
| Allowed values | |
| Preset value | 00000000 _h |

Description

Each subindex (1–16) describes a different mapped object.

A mapping entry consists of four bytes, which are structured according to the following graphic.

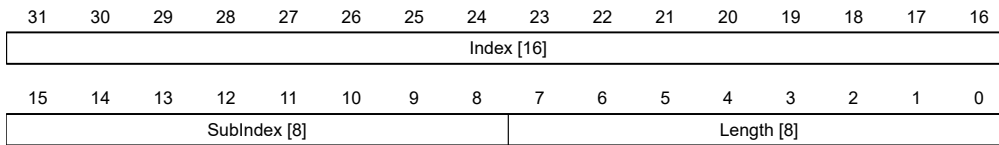

Index [16]

This contains the index of the object to be mapped

Subindex [8]

This contains the subindex of the object to be mapped

Length [8]

This contains the length of the object to be mapped in units of bits.

2320h NanoJ Output Data Selection

Function

Describes the object dictionary entries that are copied into the output PDO mapping of the *NanoJ program* after it is executed.

Object description

| | |
|------------------|-----------------------------|
| Index | 2320 _h |
| Object name | NanoJ Output Data Selection |
| Object Code | ARRAY |
| Data type | UNSIGNED32 |
| Savable | no |
| Access | read / write |
| PDO mapping | no |
| Allowed values | |
| Preset value | |
| Firmware version | FIR-v1650-B472161 |

| | |
|----------------|---|
| Change history | <p>Firmware version FIR-v1436: "Object Name" entry changed from "VMM Output Data Selection" to "NanoJ Output Data Selection".</p> <p>Firmware version FIR-v1650-B472161: "Savable" entry changed from "yes, category: application" to "no".</p> <p>Firmware version FIR-v1650-B472161: "Access" table entry for subindex 00 changed from "read/write" to "read only".</p> <p>Firmware version FIR-v1650-B472161: "Access" table entry for subindex 01 changed from "read/write" to "read only".</p> |
|----------------|---|

Value description

| | |
|----------------|-------------------|
| Subindex | 00 _h |
| Name | Number Of Entries |
| Data type | UNSIGNED8 |
| Access | read only |
| PDO mapping | no |
| Allowed values | |
| Preset value | 10 _h |

| | |
|----------------|-----------------------------------|
| Subindex | 01 _h - 10 _h |
| Name | Mapping #1 - #16 |
| Data type | UNSIGNED32 |
| Access | read only |
| PDO mapping | no |
| Allowed values | |
| Preset value | 00000000 _h |

Description

Each subindex (1–16) describes a different mapped object.

A mapping entry consists of four bytes, which are structured according to the following graphic.

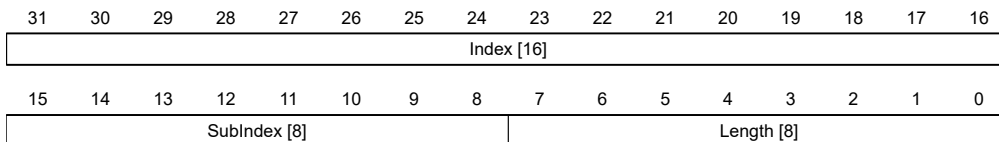

Index [16]

This contains the index of the object to be mapped

Subindex [8]

This contains the subindex of the object to be mapped

Length [8]

This contains the length of the object to be mapped in units of bits.

2330h NanoJ In/output Data Selection

Function

Describes the object dictionary entries that are first copied to the input PDO mapping of the NanoJ program and, after it is executed, are copied back to the output PDO mapping.

Object description

| | |
|------------------|---|
| Index | 2330 _h |
| Object name | NanoJ In/output Data Selection |
| Object Code | ARRAY |
| Data type | UNSIGNED32 |
| Savable | no |
| Access | read / write |
| PDO mapping | no |
| Allowed values | |
| Preset value | |
| Firmware version | FIR-v1650-B472161 |
| Change history | <p>Firmware version FIR-v1436: "Object Name" entry changed from "VMM In/output Data Selection" to "NanoJ In/output Data Selection".</p> <p>Firmware version FIR-v1650-B472161: "Savable" entry changed from "yes, category: application" to "no".</p> <p>Firmware version FIR-v1650-B472161: "Access" table entry for subindex 00 changed from "read/write" to "read only".</p> <p>Firmware version FIR-v1650-B472161: "Access" table entry for subindex 01 changed from "read/write" to "read only".</p> |

Value description

| | |
|----------------|-----------------------------------|
| Subindex | 00 _h |
| Name | Number Of Entries |
| Data type | UNSIGNED8 |
| Access | read only |
| PDO mapping | no |
| Allowed values | |
| Preset value | 10 _h |
| Subindex | 01 _h - 10 _h |
| Name | Mapping #1 - #16 |
| Data type | UNSIGNED32 |
| Access | read only |
| PDO mapping | no |
| Allowed values | |
| Preset value | 00000000 _h |

Description

Each subindex (1–16) describes a different mapped object.

A mapping entry consists of four bytes, which are structured according to the following graphic.

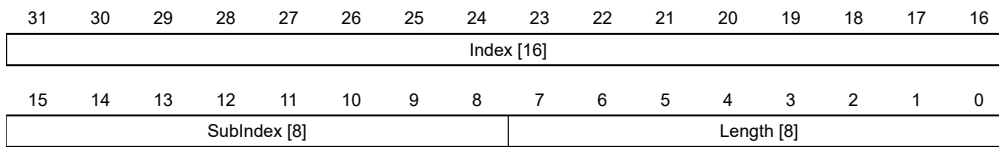

Index [16]

This contains the index of the object to be mapped

Subindex [8]

This contains the subindex of the object to be mapped

Length [8]

This contains the length of the object to be mapped in units of bits.

2400h NanoJ Inputs

Function

Located here is an array with 32, 32-bit integer values that is not used within the firmware and serves only for communicating with the user program via the fieldbus.

Object description

| | |
|------------------|--|
| Index | 2400 _h |
| Object name | NanoJ Inputs |
| Object Code | ARRAY |
| Data type | INTEGER32 |
| Savable | no |
| Firmware version | FIR-v1426 |
| Change history | <p>The number of entries was changed from 2 to 33</p> <p>Firmware version FIR-v1436: "Object Name" entry changed from "VMM Inputs" to "NanoJ Inputs".</p> <p>Firmware version FIR-v1436: "Name" entry changed from "VMM Input N#" to "NanoJ Input N#".</p> |

Value description

| | |
|----------------|-------------------|
| Subindex | 00 _h |
| Name | Number Of Entries |
| Data type | UNSIGNED8 |
| Access | read only |
| PDO mapping | no |
| Allowed values | |
| Preset value | 20 _h |

| | |
|----------------|-----------------------------------|
| Subindex | 01 _h - 20 _h |
| Name | NanoJ Input #1 - #32 |
| Data type | INTEGER32 |
| Access | read / write |
| PDO mapping | RX-PDO |
| Allowed values | |
| Preset value | 00000000 _h |

Description

Here, it is possible to pass, e.g., preset values, to the *NanoJ program*.

2410h NanoJ Init Parameters

Function

This object functions identically to object 2400_h with the difference that this object can be stored.

Object description

| | |
|------------------|--|
| Index | 2410 _h |
| Object name | NanoJ Init Parameters |
| Object Code | ARRAY |
| Data type | INTEGER32 |
| Savable | yes, category: application |
| Access | read only |
| PDO mapping | no |
| Allowed values | |
| Preset value | |
| Firmware version | FIR-v1450 |
| Change history | Firmware version FIR-v1450: "Data Type" entry changed from "INTEGER32" to "UNSIGNED8". |

Value description

| | |
|----------------|-------------------|
| Subindex | 00 _h |
| Name | Number Of Entries |
| Data type | UNSIGNED8 |
| Access | read only |
| PDO mapping | no |
| Allowed values | |
| Preset value | 20 _h |

| | |
|-----------|-----------------------------------|
| Subindex | 01 _h - 20 _h |
| Name | NanoJ Init Parameter #1 - #32 |
| Data type | INTEGER32 |
| Access | read / write |

| | |
|----------------|-----------------------|
| PDO mapping | RX-PDO |
| Allowed values | |
| Preset value | 00000000 _h |

2500h NanoJ Outputs

Function

Located here is an array with 32, 32-bit integer values that is not used within the firmware and serves only for communicating with the user program via the fieldbus.

Object description

| | |
|------------------|--|
| Index | 2500 _h |
| Object name | NanoJ Outputs |
| Object Code | ARRAY |
| Data type | INTEGER32 |
| Savable | no |
| Firmware version | FIR-v1426 |
| Change history | <p>Firmware version FIR-v1436: "Object Name" entry changed from "VMM Outputs" to "NanoJ Outputs".</p> <p>Firmware version FIR-v1436: "Name" entry changed from "VMM Output N#" to "NanoJ Output N#".</p> |

Value description

| | |
|----------------|-------------------|
| Subindex | 00 _h |
| Name | Number Of Entries |
| Data type | UNSIGNED8 |
| Access | read only |
| PDO mapping | no |
| Allowed values | |
| Preset value | 20 _h |

| | |
|----------------|-----------------------------------|
| Subindex | 01 _h - 20 _h |
| Name | NanoJ Output #1 - #32 |
| Data type | INTEGER32 |
| Access | read / write |
| PDO mapping | TX-PDO |
| Allowed values | |
| Preset value | 00000000 _h |

Description

Here, the *NanoJ program* can store results which can then be read out via the fieldbus.

2600h NanoJ Debug Output

Function

This object contains debug output of a user program.

Object description

| | |
|------------------|--|
| Index | 2600 _h |
| Object name | NanoJ Debug Output |
| Object Code | ARRAY |
| Data type | UNSIGNED8 |
| Savable | no |
| Firmware version | FIR-v1426 |
| Change history | Firmware version FIR-v1436: "Object Name" entry changed from "VMM Debug Output" to "NanoJ Debug Output". |

Value description

| | |
|----------------|-------------------|
| Subindex | 00 _h |
| Name | Number Of Entries |
| Data type | UNSIGNED8 |
| Access | read / write |
| PDO mapping | no |
| Allowed values | |
| Preset value | 00 _h |

| | |
|----------------|-----------------------------------|
| Subindex | 01 _h - 40 _h |
| Name | Value #1 - #64 |
| Data type | UNSIGNED8 |
| Access | read only |
| PDO mapping | no |
| Allowed values | |
| Preset value | 00 _h |

Description

Here, the NanoJ program stores the debug output that was called up with the `VmmDebugOutputString()` and `VmmDebugOutputInt()`.

2701h Customer Storage Area

Function

Data can be deposited and stored in this object.

Object description

| | |
|------------------|---|
| Index | 2701 _h |
| Object name | Customer Storage Area |
| Object Code | ARRAY |
| Data type | UNSIGNED32 |
| Savable | yes, category: customer |
| Access | read only |
| PDO mapping | no |
| Allowed values | |
| Preset value | |
| Firmware version | FIR-v1540 |
| Change history | Firmware version FIR-v1540: "Data Type" entry changed from "UNSIGNED32" to "UNSIGNED8". |

Value description

| | |
|----------------|-------------------|
| Subindex | 00 _h |
| Name | Number Of Entries |
| Data type | UNSIGNED8 |
| Access | read only |
| PDO mapping | no |
| Allowed values | |
| Preset value | FE _h |

| | |
|----------------|-----------------------------------|
| Subindex | 01 _h - FE _h |
| Name | Storage #1 - #254 |
| Data type | UNSIGNED32 |
| Access | read / write |
| PDO mapping | no |
| Allowed values | |
| Preset value | 00000000 _h |

2800h Bootloader And Reboot Settings

Function

Object description

| | |
|-------------|--------------------------------|
| Index | 2800 _h |
| Object name | Bootloader And Reboot Settings |
| Object Code | ARRAY |
| Data type | UNSIGNED32 |
| Savable | yes, category: application |
| Access | read only |

| | |
|------------------|-----------|
| PDO mapping | no |
| Allowed values | |
| Preset value | |
| Firmware version | FIR-v1540 |
| Change history | |

Value description

| | |
|----------------|-------------------|
| Subindex | 00 _h |
| Name | Number Of Entries |
| Data type | UNSIGNED8 |
| Access | read only |
| PDO mapping | no |
| Allowed values | |
| Preset value | 03 _h |

| | |
|----------------|-----------------------|
| Subindex | 01 _h |
| Name | Reboot Command |
| Data type | UNSIGNED32 |
| Access | read / write |
| PDO mapping | no |
| Allowed values | |
| Preset value | 00000000 _h |

| | |
|----------------|-------------------------|
| Subindex | 02 _h |
| Name | Reboot Delay Time In Ms |
| Data type | UNSIGNED32 |
| Access | read / write |
| PDO mapping | no |
| Allowed values | |
| Preset value | 00000064 _h |

| | |
|----------------|-----------------------|
| Subindex | 03 _h |
| Name | Bootloader HW Config |
| Data type | UNSIGNED32 |
| Access | read / write |
| PDO mapping | no |
| Allowed values | |
| Preset value | 00000000 _h |

Description

The subindices have the following function:

- 01_h: If the value "746F6F62_h" is entered here, the firmware is rebooted.

- 02_h: Time in milliseconds: delays the reboot of the firmware by the respective time.

306C_h Velocity Actual Internal Value

Function

Contains the current actual position in rpm.

Object description

| | |
|------------------|--------------------------------|
| Index | 306C _h |
| Object name | Velocity Actual Internal Value |
| Object Code | VARIABLE |
| Data type | INTEGER32 |
| Savable | no |
| Access | read only |
| PDO mapping | TX-PDO |
| Allowed values | |
| Preset value | 00000000 _h |
| Firmware version | FIR-v2412-B1057638 |
| Change history | |

3202_h Motor Drive Submode Select

Function

Controls the controller mode, such as the changeover between *closed-loop* / *open-loop* and whether Velocity Mode is simulated via the S-controller or functions with a real V-controller in *closed loop*.

Object description

| | |
|------------------|--|
| Index | 3202 _h |
| Object name | Motor Drive Submode Select |
| Object Code | VARIABLE |
| Data type | UNSIGNED32 |
| Savable | yes, category: drive |
| Access | read / write |
| PDO mapping | RX-PDO |
| Allowed values | |
| Preset value | 00000001 _h |
| Firmware version | FIR-v1426 |
| Change history | <p>Firmware version FIR-v1540: "Savable" entry changed from "yes category: application" to "yes, category: travel".</p> <p>Firmware version FIR-v1540: "Savable" entry changed from "yes category: travel" to "yes, category: movement".</p> |

Description

| | | | | | | | | | | | | | | | |
|----|----|----|----|----|----|----|----|------|------|--------|--------|--------|-------|-----|-------|
| 31 | 30 | 29 | 28 | 27 | 26 | 25 | 24 | 23 | 22 | 21 | 20 | 19 | 18 | 17 | 16 |
| | | | | | | | | | | | | | | | |
| 15 | 14 | 13 | 12 | 11 | 10 | 9 | 8 | 7 | 6 | 5 | 4 | 3 | 2 | 1 | 0 |
| | | | | | | | | Slow | BLDC | Torque | AutoAI | CurRed | Brake | VoS | CL/OL |

CL/OL

Changeover between *open-loop* and *closed-loop* (see chapter [Control modes](#))

- Value = "0": *open-loop*
- Value = "1": *closed loop*

Toggleing is not possible in the *Operation enabled* state.

VoS

Value = "1": Simulate V-controller with an S-ramp: simulate the speed modes through continuous position changes

Brake

Value = "1": Switch on automatic brake control.

CurRed (Current Reduction)

Current reduction in *open-loop*: Since version *FIR-v22 13*, this remains activated provided that objects 2036_h and 2037_h are not both set to "0".

Torque

only active in operating modes [Profile Torque](#) and [Cyclic Synchronous Torque](#)

Value = "1": M-controller is active, otherwise a V-controller is superimposed: no V-controller is used in the torque modes for speed limiting, thus object 6080_h is ignored; 3210_h:3 and 3210_h:4 have no effect on the control.

BLDC

Value = "1": Motor type "BLDC" (brushless DC motor)

3203h Feedback Selection

Function

In this object, the sources of the presets are defined for the commutation and the velocity and position control.

A value change in the *Operation enabled* state shows no immediate effect. Value changes in objects are buffered and read out upon changing to the *Operation enabled* state.

Object description

| | |
|-------------|-----------------------|
| Index | 3203 _h |
| Object name | Feedback Selection |
| Object Code | ARRAY |
| Data type | UNSIGNED8 |
| Savable | yes, category: tuning |
| Access | read only |
| PDO mapping | RX-PDO |

| | |
|------------------|-------------------|
| Allowed values | |
| Preset value | |
| Firmware version | FIR-v1748-B538662 |
| Change history | |

Value description

| | |
|----------------|-------------------|
| Subindex | 00 _h |
| Name | Number Of Entries |
| Data type | UNSIGNED8 |
| Access | read only |
| PDO mapping | RX-PDO |
| Allowed values | |
| Preset value | 02 _h |

| | |
|----------------|------------------------|
| Subindex | 01 _h |
| Name | 1st Feedback Interface |
| Data type | UNSIGNED8 |
| Access | read / write |
| PDO mapping | RX-PDO |
| Allowed values | |
| Preset value | 00 _h |

| | |
|----------------|------------------------|
| Subindex | 02 _h |
| Name | 2nd Feedback Interface |
| Data type | UNSIGNED8 |
| Access | read / write |
| PDO mapping | RX-PDO |
| Allowed values | |
| Preset value | 07 _h |

Description

The subindices have the following function:

- 00_h: Value="1" to "n", where "n" is the number of existing feedbacks.
- n_h:
Subindex n contains a bit mask for the respective feedback n. The bits have the following meaning here:
 - Bit 0: If the bit is set to "1", this sensor is used for position feedback.
 - Bit 1: If the bit is set to "1", this sensor is used for velocity feedback.
 - Bit 2: If the bit is set to "1", this sensor is used for commutation feedback in Closed-Loop.

Subindex 01_h always corresponds to the first (and always existing) *sensorless* feedback.

Which sensor the controller takes into account for the individual controllers (commutation, velocity, position) is implicitly specified by the order of the sensors.

The search always begins with sensor 2 and continues in ascending order until all existing sensors have been queried. If a sensor is found whose feedback is set, it is assigned to the corresponding controller and the search ended.

NOTICE



If bit 0 in 3202_h is set to "0", *closed loop* is deactivated; bit 2 (commutation) then has no meaning. Bit 1 for the velocity and bit 0 for the position in the respective subindices are still used for the display of the actual position and speed values.

3204h Feedback Mapping

Function

This object contains information on the existing feedbacks.

Object description

| | |
|------------------|-------------------|
| Index | 3204 _h |
| Object name | Feedback Mapping |
| Object Code | ARRAY |
| Data type | UNSIGNED16 |
| Savable | no |
| Access | read only |
| PDO mapping | TX-PDO |
| Allowed values | |
| Preset value | |
| Firmware version | FIR-v1748-B538662 |
| Change history | |

Value description

| | |
|----------------|---------------------------------|
| Subindex | 00 _h |
| Name | Number Of Entries |
| Data type | UNSIGNED8 |
| Access | read only |
| PDO mapping | TX-PDO |
| Allowed values | |
| Preset value | 02 _h |
| Subindex | 01 _h |
| Name | Index Of 1st Feedback Interface |
| Data type | UNSIGNED16 |
| Access | read only |
| PDO mapping | TX-PDO |
| Allowed values | |
| Preset value | 3380 _h |

| | |
|----------------|---------------------------------|
| Subindex | 02 _h |
| Name | Index Of 2nd Feedback Interface |
| Data type | UNSIGNED16 |
| Access | read only |
| PDO mapping | TX-PDO |
| Allowed values | |
| Preset value | 33A0 _h |

Description

The subindices have the following function:

- 00_h: Value="1" to "n", where "n" is the number of existing feedbacks.
- n_h:
 Subindex n refers to the index of the respective object for the configuration of the corresponding feedback.
 Subindex 01_h always corresponds to the first (and always existing) *sensorless* feedback.

3205_h Feedback Use

Function

This object shows, which sensor is used for which control loop.

Object description

| | |
|------------------|--------------------|
| Index | 3205 _h |
| Object name | Feedback Use |
| Object Code | ARRAY |
| Data type | UNSIGNED16 |
| Savable | no |
| Access | read only |
| PDO mapping | TX-PDO |
| Allowed values | |
| Preset value | |
| Firmware version | FIR-v2412-B1057638 |
| Change history | |

Value description

| | |
|----------------|-------------------|
| Subindex | 00 _h |
| Name | Number Of Entries |
| Data type | UNSIGNED8 |
| Access | read only |
| PDO mapping | TX-PDO |
| Allowed values | |
| Preset value | 04 _h |

| | |
|----------|-----------------|
| Subindex | 01 _h |
|----------|-----------------|

| | |
|----------------|----------------------------------|
| Name | Sensor For Position Control Loop |
| Data type | UNSIGNED16 |
| Access | read only |
| PDO mapping | TX-PDO |
| Allowed values | |
| Preset value | 0000 _h |

| | |
|----------------|----------------------------------|
| Subindex | 02 _h |
| Name | Sensor For Velocity Control Loop |
| Data type | UNSIGNED16 |
| Access | read only |
| PDO mapping | TX-PDO |
| Allowed values | |
| Preset value | 0000 _h |

| | |
|----------------|---------------------------------|
| Subindex | 03 _h |
| Name | Sensor For Current Control Loop |
| Data type | UNSIGNED16 |
| Access | read only |
| PDO mapping | TX-PDO |
| Allowed values | |
| Preset value | 0000 _h |

| | |
|----------------|----------------------------|
| Subindex | 04 _h |
| Name | Sensor For Pulse Generator |
| Data type | UNSIGNED16 |
| Access | read only |
| PDO mapping | TX-PDO |
| Allowed values | |
| Preset value | 0000 _h |

320Dh Torque Of Inertia Factor

Function

This factor is used for calculating the acceleration feed forward (see [321D](#)). Default is 0 (feed forward inactive).

Acceleration feed forward applies during deceleration as well.

Object description

| | |
|-------------|--------------------------|
| Index | 320D _h |
| Object name | Torque Of Inertia Factor |
| Object Code | ARRAY |
| Data type | UNSIGNED32 |

| | |
|------------------|----------------------|
| Savable | yes, category: drive |
| Access | read only |
| PDO mapping | no |
| Allowed values | |
| Preset value | |
| Firmware version | FIR-v1825-B577172 |
| Change history | |

Value description

| | |
|----------------|-------------------|
| Subindex | 00 _h |
| Name | Number Of Entries |
| Data type | UNSIGNED8 |
| Access | read only |
| PDO mapping | no |
| Allowed values | |
| Preset value | 02 _h |

| | |
|----------------|-----------------------|
| Subindex | 01 _h |
| Name | Current |
| Data type | UNSIGNED32 |
| Access | read / write |
| PDO mapping | no |
| Allowed values | |
| Preset value | 00000000 _h |

| | |
|----------------|-----------------------|
| Subindex | 02 _h |
| Name | Acceleration |
| Data type | UNSIGNED32 |
| Access | read / write |
| PDO mapping | no |
| Allowed values | |
| Preset value | 00000000 _h |

Description

The value is dependent on the inertia of the load. To determine the factor:

1. Activate closed loop and select the profile torque mode.
2. Set a target for the torque and enter the corresponding current value (mA) in 320D_h:01_h.
3. Record (e. g., in *Plug & Drive Studio*) the current speed (object 606C_h). Calculate the acceleration in the set user-defined units for the speed range, where this is constant. Enter the value in 320D_h:02_h.
 Using the speed curve in the following figure as an example:
 $(90-50)/(1200-980)=182 \text{ rpm/s}$.

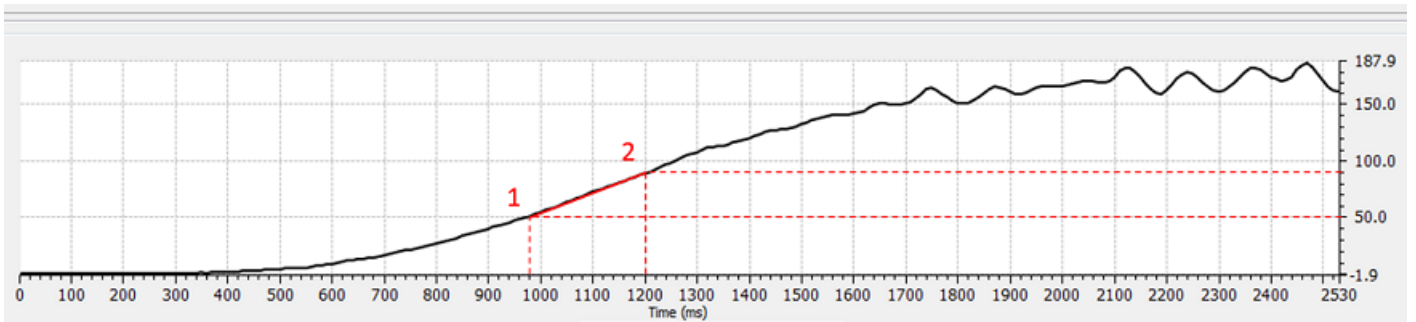

3212h Motor Drive Flags

Function

This object is used to specify whether or not auto_setup is to adapt the controller parameters. The direction of the rotating field can also be changed.

NOTICE



Changes in subindex 02_h do not take effect until after the controller is restarted. Afterwards, Auto setup must again be performed.

Object description

| | |
|------------------|--|
| Index | 3212 _h |
| Object name | Motor Drive Flags |
| Object Code | ARRAY |
| Data type | INTEGER8 |
| Savable | yes, category: application |
| Access | read only |
| PDO mapping | no |
| Allowed values | |
| Preset value | |
| Firmware version | FIR-v1450 |
| Change history | <p>Firmware version FIR-v1512: The number of entries was changed from 2 to 3.</p> <p>Firmware version FIR-v1738-B501312: "Name" entry changed from "Enable Legacy Power Mode" to "Reserved".</p> |

Value description

| | |
|----------------|-------------------|
| Subindex | 00 _h |
| Name | Number Of Entries |
| Data type | UNSIGNED8 |
| Access | read only |
| PDO mapping | no |
| Allowed values | |
| Preset value | 03 _h |

| | |
|----------------|-----------------|
| Subindex | 01 _h |
| Name | Reserved |
| Data type | INTEGER8 |
| Access | read / write |
| PDO mapping | no |
| Allowed values | |
| Preset value | 00 _h |

| | |
|----------------|--------------------------|
| Subindex | 02 _h |
| Name | Override Field Inversion |
| Data type | INTEGER8 |
| Access | read / write |
| PDO mapping | no |
| Allowed values | |
| Preset value | 00 _h |

| | |
|----------------|---|
| Subindex | 03 _h |
| Name | Auto-setup With Current Controller Parameters From The OD |
| Data type | INTEGER8 |
| Access | read / write |
| PDO mapping | no |
| Allowed values | |
| Preset value | 00 _h |

Description

Valid values for subindex 02_h:

- Value = "0": Use default values of the firmware
- Value = "1": Force non-inversion of the rotating field (mathematically positive)
- Value = "-1": Force inversion of the rotating field (mathematically negative)

Valid values for subindex 03_h:

- Value = "0": Auto setup detects the motor type (stepper motor or BLDC motor) and uses the corresponding pre-configured parameter set.
- Value = "1": Perform auto setup with the control parameters that were entered in object 3210_h or 321A_h to 321E_h before the auto setup. The control parameters are not changed.

321Ah Current Controller Parameters

Function

Contains the parameters for the current controller (commutation). As a rule, the values for I_q (subindex 01_h/02_h) and I_d (subindex 03_h/04_h) should be the same. See chapter Controller structure.

Object description

| | |
|-------------|-------------------------------|
| Index | 321A _h |
| Object name | Current Controller Parameters |

| | |
|------------------|----------------------------|
| Object Code | ARRAY |
| Data type | UNSIGNED32 |
| Savable | yes, category: application |
| Access | read only |
| PDO mapping | no |
| Allowed values | |
| Preset value | |
| Firmware version | FIR-v2213-B1028181 |
| Change history | |

Value description

| | |
|----------------|-------------------|
| Subindex | 00 _h |
| Name | Number Of Entries |
| Data type | UNSIGNED8 |
| Access | read only |
| PDO mapping | no |
| Allowed values | |
| Preset value | 04 _h |

| | |
|----------------|--|
| Subindex | 01 _h |
| Name | Proportional Gain Kp For Iq [mV/A] |
| Data type | UNSIGNED32 |
| Access | read / write |
| PDO mapping | no |
| Allowed values | |
| Preset value | <ul style="list-style-type: none"> ■ PD1-C281S15-E-20-2: 00000F76_h ■ PD1-C281S15-E-20-5: 00000F76_h ■ PD1-C281S15-E-65-2: 00000F76_h ■ PD1-C281S15-E-65-5: 00000F76_h ■ PD1-C281S15-E-OF-2: 00000F76_h ■ PD1-C281S15-E-OF-5: 00000F76_h ■ PD1-C281L15-E-20-2: 00001DB0_h ■ PD1-C281L15-E-20-5: 00001DB0_h ■ PD1-C281L15-E-65-2: 00001DB0_h ■ PD1-C281L15-E-65-5: 00001DB0_h ■ PD1-C281L15-E-OF-2: 00001DB0_h ■ PD1-C281L15-E-OF-5: 00001DB0_h |

| | |
|----------------|--------------------------------|
| Subindex | 02 _h |
| Name | Integrator Time Ti For Iq [μs] |
| Data type | UNSIGNED32 |
| Access | read / write |
| PDO mapping | no |
| Allowed values | |

| | |
|--------------|--|
| Preset value | <ul style="list-style-type: none"> ■ PD1-C281S15-E-20-2: 0000032B_h ■ PD1-C281S15-E-20-5: 0000032B_h ■ PD1-C281S15-E-65-2: 0000032B_h ■ PD1-C281S15-E-65-5: 0000032B_h ■ PD1-C281S15-E-OF-2: 0000032B_h ■ PD1-C281S15-E-OF-5: 0000032B_h ■ PD1-C281L15-E-20-2: 000003E8_h ■ PD1-C281L15-E-20-5: 000003E8_h ■ PD1-C281L15-E-65-2: 000003E8_h ■ PD1-C281L15-E-65-5: 000003E8_h ■ PD1-C281L15-E-OF-2: 000003E8_h ■ PD1-C281L15-E-OF-5: 000003E8_h |
|--------------|--|

| | |
|----------------|--|
| Subindex | 03 _h |
| Name | Proportional Gain Kp For Id [mV/A] |
| Data type | UNSIGNED32 |
| Access | read / write |
| PDO mapping | no |
| Allowed values | |
| Preset value | <ul style="list-style-type: none"> ■ PD1-C281S15-E-20-2: 00000F76_h ■ PD1-C281S15-E-20-5: 00000F76_h ■ PD1-C281S15-E-65-2: 00000F76_h ■ PD1-C281S15-E-65-5: 00000F76_h ■ PD1-C281S15-E-OF-2: 00000F76_h ■ PD1-C281S15-E-OF-5: 00000F76_h ■ PD1-C281L15-E-20-2: 00001DB0_h ■ PD1-C281L15-E-20-5: 00001DB0_h ■ PD1-C281L15-E-65-2: 00001DB0_h ■ PD1-C281L15-E-65-5: 00001DB0_h ■ PD1-C281L15-E-OF-2: 00001DB0_h ■ PD1-C281L15-E-OF-5: 00001DB0_h |

| | |
|----------------|--|
| Subindex | 04 _h |
| Name | Integrator Time Ti For Id [μs] |
| Data type | UNSIGNED32 |
| Access | read / write |
| PDO mapping | no |
| Allowed values | |
| Preset value | <ul style="list-style-type: none"> ■ PD1-C281S15-E-20-2: 0000032B_h ■ PD1-C281S15-E-20-5: 0000032B_h ■ PD1-C281S15-E-65-2: 0000032B_h ■ PD1-C281S15-E-65-5: 0000032B_h ■ PD1-C281S15-E-OF-2: 0000032B_h ■ PD1-C281S15-E-OF-5: 0000032B_h ■ PD1-C281L15-E-20-2: 000003E8_h ■ PD1-C281L15-E-20-5: 000003E8_h ■ PD1-C281L15-E-65-2: 000003E8_h |

- PD1-C281L15-E-65-5: 000003E8_h
- PD1-C281L15-E-OF-2: 000003E8_h
- PD1-C281L15-E-OF-5: 000003E8_h

321Bh Velocity Controller Parameters

Function

Contains the parameters for the velocity controller. See chapter [Controller structure](#).

Object description

| | |
|------------------|--------------------------------|
| Index | 321B _h |
| Object name | Velocity Controller Parameters |
| Object Code | ARRAY |
| Data type | UNSIGNED32 |
| Savable | yes, category: application |
| Access | read only |
| PDO mapping | no |
| Allowed values | |
| Preset value | |
| Firmware version | FIR-v2213-B1028181 |
| Change history | |

Value description

| | |
|----------------|-------------------|
| Subindex | 00 _h |
| Name | Number Of Entries |
| Data type | UNSIGNED8 |
| Access | read only |
| PDO mapping | no |
| Allowed values | |
| Preset value | 02 _h |

| | |
|----------------|------------------------------|
| Subindex | 01 _h |
| Name | Proportional Gain Kp [mA/Hz] |
| Data type | UNSIGNED32 |
| Access | read / write |
| PDO mapping | no |
| Allowed values | |
| Preset value | 00000032 _h |

| | |
|-----------|-------------------------|
| Subindex | 02 _h |
| Name | Integrator Time Ti [μs] |
| Data type | UNSIGNED32 |

| | |
|----------------|--|
| Access | read / write |
| PDO mapping | no |
| Allowed values | |
| Preset value | <ul style="list-style-type: none"> ■ PD1-C281S15-E-20-2: 000061A8_h ■ PD1-C281S15-E-20-5: 000061A8_h ■ PD1-C281S15-E-65-2: 000061A8_h ■ PD1-C281S15-E-65-5: 000061A8_h ■ PD1-C281S15-E-OF-2: 000061A8_h ■ PD1-C281S15-E-OF-5: 000061A8_h ■ PD1-C281L15-E-20-2: 00004B00_h ■ PD1-C281L15-E-20-5: 00004B00_h ■ PD1-C281L15-E-65-2: 00004B00_h ■ PD1-C281L15-E-65-5: 00004B00_h ■ PD1-C281L15-E-OF-2: 00004B00_h ■ PD1-C281L15-E-OF-5: 00004B00_h |

321Ch Position Controller Parameters

Function

Contains the parameters for the position controller. See chapter [Controller structure](#).

Object description

| | |
|------------------|--------------------------------|
| Index | 321C _h |
| Object name | Position Controller Parameters |
| Object Code | ARRAY |
| Data type | UNSIGNED32 |
| Savable | yes, category: application |
| Access | read only |
| PDO mapping | no |
| Allowed values | |
| Preset value | |
| Firmware version | FIR-v2213-B1028181 |
| Change history | |

Value description

| | |
|----------------|-------------------|
| Subindex | 00 _h |
| Name | Number Of Entries |
| Data type | UNSIGNED8 |
| Access | read only |
| PDO mapping | no |
| Allowed values | |
| Preset value | 02 _h |

| | |
|----------|-----------------|
| Subindex | 01 _h |
|----------|-----------------|

| | |
|----------------|--|
| Name | Proportional Gain Kp [Hz] |
| Data type | UNSIGNED32 |
| Access | read / write |
| PDO mapping | no |
| Allowed values | |
| Preset value | <ul style="list-style-type: none"> ■ PD1-C281S15-E-20-2: 00002710_h ■ PD1-C281S15-E-20-5: 00002710_h ■ PD1-C281S15-E-65-2: 00002710_h ■ PD1-C281S15-E-65-5: 00002710_h ■ PD1-C281S15-E-OF-2: 00002710_h ■ PD1-C281S15-E-OF-5: 00002710_h ■ PD1-C281L15-E-20-2: 0000C350_h ■ PD1-C281L15-E-20-5: 0000C350_h ■ PD1-C281L15-E-65-2: 0000C350_h ■ PD1-C281L15-E-65-5: 0000C350_h ■ PD1-C281L15-E-OF-2: 0000C350_h ■ PD1-C281L15-E-OF-5: 0000C350_h |

| | |
|----------------|-------------------------|
| Subindex | 02 _h |
| Name | Integrator Time Ti [μs] |
| Data type | UNSIGNED32 |
| Access | read / write |
| PDO mapping | no |
| Allowed values | |
| Preset value | 00000000 _h |

321Dh Feedforward

Function

Contains the parameters for the feed forward. See chapter [Controller structure](#).

Object description

| | |
|------------------|---|
| Index | 321D _h |
| Object name | Feedforward |
| Object Code | ARRAY |
| Data type | UNSIGNED16 |
| Savable | yes, category: application |
| Access | read only |
| PDO mapping | no |
| Allowed values | |
| Preset value | |
| Firmware version | FIR-v2213-B1028181 |
| Change history | Firmware version FIR-v2315-B1040535: "Data type" entry changed from "UNSIGNED32" to "UNSIGNED16". |

Firmware version FIR-v2315-B1040535: "Data type" entry changed from "UNSIGNED32" to "UNSIGNED16".

Firmware version FIR-v2315-B1040535: "Data type" entry changed from "UNSIGNED32" to "UNSIGNED16".

Firmware version FIR-v2315-B1040535: "Data type" entry changed from "UNSIGNED32" to "UNSIGNED16".

Firmware version FIR-v2412-B1057638: entry "Object Name" changed from "Pre-control" to "Feedforward".

Firmware version FIR-v2412-B1057638: entry "Name" changed from "Voltage Pre-control For Dq-decoupling [%]" to "Voltage Feedforward For Dq-decoupling [%]".

Firmware version FIR-v2412-B1057638: entry "Name" changed from "Acceleration Pre-control [%]" to "Acceleration Feedforward [%]".

Firmware version FIR-v2412-B1057638: entry "Name" changed from "Velocity Pre-control [%]" to "Velocity Feedforward [%]".

Firmware version FIR-v2412-B1057638: entry "Name" changed from "Ohmic Based Voltage Pre-control [%]" to "Ohmic Based Voltage Feedforward [%]".

Value description

| | |
|----------------|-------------------|
| Subindex | 00 _h |
| Name | Number Of Entries |
| Data type | UNSIGNED8 |
| Access | read only |
| PDO mapping | no |
| Allowed values | |
| Preset value | 04 _h |

| | |
|----------------|---|
| Subindex | 01 _h |
| Name | Voltage Feedforward For Dq-decoupling [%] |
| Data type | UNSIGNED16 |
| Access | read / write |
| PDO mapping | no |
| Allowed values | |
| Preset value | 03E8 _h |

| | |
|----------------|------------------------------|
| Subindex | 02 _h |
| Name | Acceleration Feedforward [%] |
| Data type | UNSIGNED16 |
| Access | read / write |
| PDO mapping | no |
| Allowed values | |
| Preset value | 03E8 _h |

| | |
|----------------|--------------------------|
| Subindex | 03 _h |
| Name | Velocity Feedforward [%] |
| Data type | UNSIGNED16 |
| Access | read / write |
| PDO mapping | no |
| Allowed values | |
| Preset value | 03E8 _h |

| | |
|----------------|-------------------------------------|
| Subindex | 04 _h |
| Name | Ohmic Based Voltage Feedforward [%] |
| Data type | UNSIGNED16 |
| Access | read / write |
| PDO mapping | no |
| Allowed values | |
| Preset value | 0000 _h |

321Eh Voltage Limit

Function

Maximum permissible PWM voltage (duty cycle). Values ≤ 1000 are interpreted as per mil values (of the available voltage). Values > 1000 as millivolt. See also chapter [Controller structure](#).

Object description

| | |
|------------------|----------------------------|
| Index | 321E _h |
| Object name | Voltage Limit |
| Object Code | VARIABLE |
| Data type | UNSIGNED32 |
| Savable | yes, category: application |
| Access | read / write |
| PDO mapping | no |
| Allowed values | |
| Preset value | 000186A0 _h |
| Firmware version | FIR-v2213-B1028181 |
| Change history | |

Description

Also dependent on this value is whether the *overmodulation* of the voltage vector is used. If *overmodulation* is used, a higher torque can be achieved. The resulting voltage is no longer sinusoidal, which can result in harmonics and higher losses.

| Value in mV | Overmodulation |
|--------------------------------|--|
| $1001 \dots U_{o_low}$ | None; the voltage vector describes a circle. |
| $U_{o_low} \dots U_{o_high}$ | The voltage vector describes a circle that is increasingly flattened on four/six sides in proportion to the set value. |
| $\geq U_{o_high}$ | Full; the voltage vector describes a square or a hexagon. |

U_{o_low}

The lowest voltage above which overmodulation occurs. Is calculated as follows:

Operating voltage*0.9425

U_{o_high}

The maximum overmodulation occurs above this voltage. Is calculated as follows:

With two-phase stepper motors: operating voltage*1.063

With three-phase BLDC motors: operating voltage*0.99

3220h Analog Input Digits

Function

Displays the instantaneous values of the analog inputs in *ADC digits*.

Object description

| | |
|------------------|---------------------|
| Index | 3220 _h |
| Object name | Analog Input Digits |
| Object Code | ARRAY |
| Data type | INTEGER16 |
| Savable | no |
| Access | read only |
| PDO mapping | no |
| Allowed values | |
| Preset value | |
| Firmware version | FIR-v1426 |
| Change history | |

Value description

| | |
|----------------|-------------------------------|
| Subindex | 00 _h |
| Name | Number Of Analog Input Digits |
| Data type | UNSIGNED8 |
| Access | read only |
| PDO mapping | no |
| Allowed values | |
| Preset value | 01 _h |

| | |
|----------------|-----------------------|
| Subindex | 01 _h |
| Name | Analog Input #1 Digit |
| Data type | INTEGER16 |
| Access | read only |
| PDO mapping | TX-PDO |
| Allowed values | |
| Preset value | 0000 _h |

Description

Formulas for converting from [digits] to the respective unit:

- Current input (if configurable): $x \text{ digits} * 20 \text{ mA} / 1023 \text{ digits}$

323Ah User Pin Settings

Function

With this object, you can configure the digital inputs/outputs as described in chapter [Digital inputs and outputs](#).

Object description

| | |
|------------------|----------------------------|
| Index | 323A _h |
| Object name | User Pin Settings |
| Object Code | ARRAY |
| Data type | UNSIGNED8 |
| Savable | yes, category: application |
| Access | read only |
| PDO mapping | no |
| Allowed values | |
| Preset value | |
| Firmware version | FIR-v2339-B1048823 |
| Change history | |

Value description

| | |
|----------------|-------------------|
| Subindex | 00 _h |
| Name | Number Of Entries |
| Data type | UNSIGNED8 |
| Access | read only |
| PDO mapping | no |
| Allowed values | |
| Preset value | 02 _h |

| | |
|----------------|----------------------|
| Subindex | 01 _h |
| Name | Voltage Level Select |
| Data type | UNSIGNED8 |
| Access | read / write |
| PDO mapping | RX-PDO |
| Allowed values | |
| Preset value | 00 _h |

| | |
|-----------|-----------------|
| Subindex | 02 _h |
| Name | Pull-Up Enable |
| Data type | UNSIGNED8 |
| Access | read / write |

| | |
|----------------|-----------------|
| PDO mapping | RX-PDO |
| Allowed values | |
| Preset value | 00 _h |

Description

- Subindex 01_h: Here, you define the level for the inputs/outputs:
 - Value "0": 5 V
 - Value "1": 24 V (inputs) or +UB (outputs)



NOTICE

Use for the inputs a voltage that is smaller than the voltage +UB .

- Subindex 02_h: Here, you define the type of digital inputs:
 - Value "0" (Pull-Down): High level when 5/24 V at Pin.
 - Value "1" (Pull-Up): High level without external voltage at Pin.

3241h Digital Input Position Capture

Function

With this object, the encoder position can be noted automatically if a level change occurs at digital input .

Object description

| | |
|------------------|--|
| Index | 3241 _h |
| Object name | Digital Input Position Capture |
| Object Code | ARRAY |
| Data type | UNSIGNED32 |
| Savable | yes, category: application |
| Access | read only |
| PDO mapping | TX-PDO |
| Allowed values | |
| Preset value | |
| Firmware version | FIR-v1446 |
| Change history | <p>Firmware version FIR-v1446: "Data type" entry changed from "UNSIGNED32" to "UNSIGNED8".</p> <p>Firmware version FIR-v1738-B501312: "Name" entry changed from "Encoder Raw Value" to "Sensor Raw Value".</p> <p>Firmware version FIR-v1748-B531667: "PDO mapping" table entry for subindex 00 changed from "no" to "TX-PDO".</p> <p>Firmware version FIR-v1748-B531667: "PDO mapping" table entry for subindex 01 changed from "RX-PDO" to "TX-PDO".</p> <p>Firmware version FIR-v1748-B531667: "PDO mapping" table entry for subindex 02 changed from "RX-PDO" to "TX-PDO".</p> <p>Firmware version FIR-v1748-B531667: "PDO mapping" table entry for subindex 03 changed from "RX-PDO" to "TX-PDO".</p> <p>Firmware version FIR-v1748-B531667: "PDO mapping" table entry for subindex 04 changed from "RX-PDO" to "TX-PDO".</p> |

Value description

| | |
|----------------|-------------------|
| Subindex | 00 _h |
| Name | Number Of Entries |
| Data type | UNSIGNED8 |
| Access | read only |
| PDO mapping | TX-PDO |
| Allowed values | |
| Preset value | 04 _h |

| | |
|----------------|--------------------------------------|
| Subindex | 01 _h - 04 _h |
| Name | Control For Capture Of Input #1 - #4 |
| Data type | UNSIGNED32 |
| Access | read / write |
| PDO mapping | TX-PDO |
| Allowed values | |
| Preset value | 00000000 _h |

Description

- Subindex 01_h: This is used to select the type of level change:
 - Deactivate function: Value "0"
 - With rising edge: Value "1"
 - With falling edge: Value "2"
 - Both edges: Value "3"
- Subindex 02_h: Specifies the number of the noted level changes since the time the function was started; is reset to 0 if subindex 01_h is set to 1,2 or 3
- Subindex 03_h: Encoder position of the level change (in absolute user units from 6064_h)
- Subindex 04_h: Encoder position of the level change

3242h Digital Input Routing

Function

This object determines the source of the input routing that ends in 60FD_h.

Object description

| | |
|------------------|----------------------------|
| Index | 3242 _h |
| Object name | Digital Input Routing |
| Object Code | ARRAY |
| Data type | UNSIGNED8 |
| Savable | yes, category: application |
| Access | read only |
| PDO mapping | no |
| Allowed values | |
| Preset value | |
| Firmware version | FIR-v1504 |
| Change history | |

Value description

| | |
|----------------|-------------------|
| Subindex | 00 _h |
| Name | Number Of Entries |
| Data type | UNSIGNED8 |
| Access | read only |
| PDO mapping | no |
| Allowed values | |
| Preset value | 20 _h |

| | |
|----------------|--|
| Subindex | 01 _h |
| Name | Input Source For Bit #0 In 60FDh - Negative Limit Switch |
| Data type | UNSIGNED8 |
| Access | read / write |
| PDO mapping | TX-PDO |
| Allowed values | |
| Preset value | 00 _h |

| | |
|----------------|--|
| Subindex | 02 _h |
| Name | Input Source For Bit #1 In 60FDh - Positive Limit Switch |
| Data type | UNSIGNED8 |
| Access | read / write |
| PDO mapping | TX-PDO |
| Allowed values | |
| Preset value | 00 _h |

| | |
|----------------|--|
| Subindex | 03 _h |
| Name | Input Source For Bit #2 In 60FDh - Home Switch |
| Data type | UNSIGNED8 |
| Access | read / write |
| PDO mapping | TX-PDO |
| Allowed values | |
| Preset value | 00 _h |

| | |
|----------------|--|
| Subindex | 04 _h |
| Name | Input Source For Bit #3 In 60FDh - Interlock |
| Data type | UNSIGNED8 |
| Access | read / write |
| PDO mapping | TX-PDO |
| Allowed values | |
| Preset value | 00 _h |

| | |
|----------|-----------------|
| Subindex | 05 _h |
|----------|-----------------|

| | |
|----------------|----------------------------------|
| Name | Input Source For Bit #4 In 60FDh |
| Data type | UNSIGNED8 |
| Access | read / write |
| PDO mapping | TX-PDO |
| Allowed values | |
| Preset value | 00 _h |

| | |
|----------------|----------------------------------|
| Subindex | 06 _h |
| Name | Input Source For Bit #5 In 60FDh |
| Data type | UNSIGNED8 |
| Access | read / write |
| PDO mapping | TX-PDO |
| Allowed values | |
| Preset value | 00 _h |

| | |
|----------------|----------------------------------|
| Subindex | 07 _h |
| Name | Input Source For Bit #6 In 60FDh |
| Data type | UNSIGNED8 |
| Access | read / write |
| PDO mapping | TX-PDO |
| Allowed values | |
| Preset value | 00 _h |

| | |
|----------------|----------------------------------|
| Subindex | 08 _h |
| Name | Input Source For Bit #7 In 60FDh |
| Data type | UNSIGNED8 |
| Access | read / write |
| PDO mapping | TX-PDO |
| Allowed values | |
| Preset value | 00 _h |

| | |
|----------------|----------------------------------|
| Subindex | 09 _h |
| Name | Input Source For Bit #8 In 60FDh |
| Data type | UNSIGNED8 |
| Access | read / write |
| PDO mapping | TX-PDO |
| Allowed values | |
| Preset value | 00 _h |

| | |
|-----------|----------------------------------|
| Subindex | 0A _h |
| Name | Input Source For Bit #9 In 60FDh |
| Data type | UNSIGNED8 |
| Access | read / write |

| | |
|----------------|-----------------------------------|
| PDO mapping | TX-PDO |
| Allowed values | |
| Preset value | 00 _h |
| <hr/> | |
| Subindex | 0B _h |
| Name | Input Source For Bit #10 In 60FDh |
| Data type | UNSIGNED8 |
| Access | read / write |
| PDO mapping | TX-PDO |
| Allowed values | |
| Preset value | 00 _h |
| <hr/> | |
| Subindex | 0C _h |
| Name | Input Source For Bit #11 In 60FDh |
| Data type | UNSIGNED8 |
| Access | read / write |
| PDO mapping | TX-PDO |
| Allowed values | |
| Preset value | 00 _h |
| <hr/> | |
| Subindex | 0D _h |
| Name | Input Source For Bit #12 In 60FDh |
| Data type | UNSIGNED8 |
| Access | read / write |
| PDO mapping | TX-PDO |
| Allowed values | |
| Preset value | 00 _h |
| <hr/> | |
| Subindex | 0E _h |
| Name | Input Source For Bit #13 In 60FDh |
| Data type | UNSIGNED8 |
| Access | read / write |
| PDO mapping | TX-PDO |
| Allowed values | |
| Preset value | 00 _h |
| <hr/> | |
| Subindex | 0F _h |
| Name | Input Source For Bit #14 In 60FDh |
| Data type | UNSIGNED8 |
| Access | read / write |
| PDO mapping | TX-PDO |
| Allowed values | |
| Preset value | 00 _h |

| | |
|----------------|-----------------------------------|
| Subindex | 10 _h |
| Name | Input Source For Bit #15 In 60FDh |
| Data type | UNSIGNED8 |
| Access | read / write |
| PDO mapping | TX-PDO |
| Allowed values | |
| Preset value | 00 _h |
| Subindex | 11 _h |
| Name | Input Source For Bit #16 In 60FDh |
| Data type | UNSIGNED8 |
| Access | read / write |
| PDO mapping | TX-PDO |
| Allowed values | |
| Preset value | 01 _h |
| Subindex | 12 _h |
| Name | Input Source For Bit #17 In 60FDh |
| Data type | UNSIGNED8 |
| Access | read / write |
| PDO mapping | TX-PDO |
| Allowed values | |
| Preset value | 02 _h |
| Subindex | 13 _h |
| Name | Input Source For Bit #18 In 60FDh |
| Data type | UNSIGNED8 |
| Access | read / write |
| PDO mapping | TX-PDO |
| Allowed values | |
| Preset value | 03 _h |
| Subindex | 14 _h |
| Name | Input Source For Bit #19 In 60FDh |
| Data type | UNSIGNED8 |
| Access | read / write |
| PDO mapping | TX-PDO |
| Allowed values | |
| Preset value | 04 _h |
| Subindex | 15 _h |
| Name | Input Source For Bit #20 In 60FDh |
| Data type | UNSIGNED8 |

| | |
|----------------|-----------------|
| Access | read / write |
| PDO mapping | TX-PDO |
| Allowed values | |
| Preset value | 05 _h |

| | |
|----------------|-----------------------------------|
| Subindex | 16 _h |
| Name | Input Source For Bit #21 In 60FDh |
| Data type | UNSIGNED8 |
| Access | read / write |
| PDO mapping | TX-PDO |
| Allowed values | |
| Preset value | 06 _h |

| | |
|----------------|-----------------------------------|
| Subindex | 17 _h |
| Name | Input Source For Bit #22 In 60FDh |
| Data type | UNSIGNED8 |
| Access | read / write |
| PDO mapping | TX-PDO |
| Allowed values | |
| Preset value | 5A _h |

| | |
|----------------|-----------------------------------|
| Subindex | 18 _h |
| Name | Input Source For Bit #23 In 60FDh |
| Data type | UNSIGNED8 |
| Access | read / write |
| PDO mapping | TX-PDO |
| Allowed values | |
| Preset value | 5B _h |

| | |
|----------------|-----------------------------------|
| Subindex | 19 _h |
| Name | Input Source For Bit #24 In 60FDh |
| Data type | UNSIGNED8 |
| Access | read / write |
| PDO mapping | TX-PDO |
| Allowed values | |
| Preset value | 07 _h |

| | |
|----------------|-----------------------------------|
| Subindex | 1A _h |
| Name | Input Source For Bit #25 In 60FDh |
| Data type | UNSIGNED8 |
| Access | read / write |
| PDO mapping | TX-PDO |
| Allowed values | |

| | |
|----------------|-----------------------------------|
| Preset value | 08 _h |
| Subindex | 1B _h |
| Name | Input Source For Bit #26 In 60FDh |
| Data type | UNSIGNED8 |
| Access | read / write |
| PDO mapping | TX-PDO |
| Allowed values | |
| Preset value | 09 _h |
| Subindex | 1C _h |
| Name | Input Source For Bit #27 In 60FDh |
| Data type | UNSIGNED8 |
| Access | read / write |
| PDO mapping | TX-PDO |
| Allowed values | |
| Preset value | 0A _h |
| Subindex | 1D _h |
| Name | Input Source For Bit #28 In 60FDh |
| Data type | UNSIGNED8 |
| Access | read / write |
| PDO mapping | TX-PDO |
| Allowed values | |
| Preset value | 0B _h |
| Subindex | 1E _h |
| Name | Input Source For Bit #29 In 60FDh |
| Data type | UNSIGNED8 |
| Access | read / write |
| PDO mapping | TX-PDO |
| Allowed values | |
| Preset value | 0C _h |
| Subindex | 1F _h |
| Name | Input Source For Bit #30 In 60FDh |
| Data type | UNSIGNED8 |
| Access | read / write |
| PDO mapping | TX-PDO |
| Allowed values | |
| Preset value | 0D _h |
| Subindex | 20 _h |

| | |
|----------------|-----------------------------------|
| Name | Input Source For Bit #31 In 60FDh |
| Data type | UNSIGNED8 |
| Access | read / write |
| PDO mapping | TX-PDO |
| Allowed values | |
| Preset value | 0E _h |

3243h Home Switch Position Capture

Function

With this object, the current position can be noted automatically if a level change occurs at the digital input that is used for the home switch.

NOTICE



Do not use this function in combination with a homing operation. The homing operation cannot otherwise be successfully completed.

Object description

| | |
|------------------|---|
| Index | 3243 _h |
| Object name | Home Switch Position Capture |
| Object Code | ARRAY |
| Data type | UNSIGNED32 |
| Savable | yes, category: application |
| Access | read only |
| PDO mapping | no |
| Allowed values | |
| Preset value | |
| Firmware version | FIR-v1738-B501312 |
| Change history | Firmware version FIR-v2315-B1040535: "Object Name" entry changed from "Digital Input Homing Capture" to "Home Switch Position Capture". |

Value description

| | |
|----------------|-------------------|
| Subindex | 00 _h |
| Name | Number Of Entries |
| Data type | UNSIGNED8 |
| Access | read only |
| PDO mapping | no |
| Allowed values | |
| Preset value | 04 _h |

| | |
|----------|-----------------|
| Subindex | 01 _h |
|----------|-----------------|

| | |
|----------------|-----------------------|
| Name | Control |
| Data type | UNSIGNED32 |
| Access | read / write |
| PDO mapping | RX-PDO |
| Allowed values | |
| Preset value | 00000000 _h |

| | |
|----------------|-----------------------|
| Subindex | 02 _h |
| Name | Capture Count |
| Data type | UNSIGNED32 |
| Access | read / write |
| PDO mapping | RX-PDO |
| Allowed values | |
| Preset value | 00000000 _h |

| | |
|----------------|-----------------------|
| Subindex | 03 _h |
| Name | Value |
| Data type | UNSIGNED32 |
| Access | read / write |
| PDO mapping | RX-PDO |
| Allowed values | |
| Preset value | 00000000 _h |

| | |
|----------------|-----------------------|
| Subindex | 04 _h |
| Name | Sensor Raw Value |
| Data type | UNSIGNED32 |
| Access | read / write |
| PDO mapping | RX-PDO |
| Allowed values | |
| Preset value | 00000000 _h |

Description

- Subindex 01_h: This is used to select the type of level change:
 - Deactivate function: Value "0"
 - With rising edge: Value "1"
 - With falling edge: Value "2"
 - Both edges: Value "3"
- Subindex 02_h: Specifies the number of the noted level changes since the time the function was started; is reset to 0 if subindex 01_h is set to 1,2 or 3
- Subindex 03_h: Encoder position of the level change (in absolute user units from 6064_h)
- Subindex 04_h: Encoder position of the level change

324Ah Inputs

Function

You read out the current status of the inputs from this object.

Object description

| | |
|------------------|--------------------|
| Index | 324A _h |
| Object name | Inputs |
| Object Code | ARRAY |
| Data type | UNSIGNED16 |
| Savable | no |
| Access | read only |
| PDO mapping | no |
| Allowed values | |
| Preset value | |
| Firmware version | FIR-v2339-B1048823 |
| Change history | |

Value description

| | |
|----------------|-------------------|
| Subindex | 00 _h |
| Name | Number Of Entries |
| Data type | UNSIGNED8 |
| Access | read only |
| PDO mapping | no |
| Allowed values | |
| Preset value | 02 _h |

| | |
|----------------|-------------------|
| Subindex | 01 _h |
| Name | User Inputs |
| Data type | UNSIGNED16 |
| Access | read only |
| PDO mapping | no |
| Allowed values | |
| Preset value | 0000 _h |

| | |
|----------------|-------------------|
| Subindex | 02 _h |
| Name | Encoder Inputs |
| Data type | UNSIGNED16 |
| Access | read only |
| PDO mapping | no |
| Allowed values | |
| Preset value | 0000 _h |

Description

- Subindex 01_h: Shows the status of the following inputs:
 - Bits 0 to 5: Digital inputs 1 to 6 (exact number dependent on product)
 - Bits 6 and 7: Analog inputs 1 and 2 as digital input (exact number dependent on product)
- Subindex 02_h: Shows the status of the following sensor inputs:
 - Bits 0 to 2: Hall sensors 1 to 3 (if present)
 - Bits 3 to 5: Channels A, B, index of the first incremental encoder (if present)
 - Bits 6 to 8: Channels A, B index of the second incremental encoder (if present)

3250h Digital Outputs Control

Function



NOTICE

This object has no function with this product. See also chapter "Digital inputs and outputs".

Object description

| | |
|------------------|---|
| Index | 3250 _h |
| Object name | Digital Outputs Control |
| Object Code | ARRAY |
| Data type | UNSIGNED32 |
| Savable | yes, category: application |
| Access | read only |
| PDO mapping | no |
| Allowed values | |
| Preset value | |
| Firmware version | FIR-v1426 |
| Change history | <p>Firmware version FIR-v1426: Subindex 01_h: "Name" entry changed from "Special Function Disable" to "Special Function Enable"</p> <p>Firmware version FIR-v1446: "Name" entry changed from "Special Function Enable" to "No Function".</p> <p>Firmware version FIR-v1512: The number of entries was changed from 6 to 9.</p> <p>Firmware version FIR-v2039: Subindex 09 added</p> |

Value description

| | |
|----------------|-------------------|
| Subindex | 00 _h |
| Name | Number Of Entries |
| Data type | UNSIGNED8 |
| Access | read only |
| PDO mapping | no |
| Allowed values | |
| Preset value | 01 _h |

| | |
|----------------|---|
| Subindex | 01 _h |
| Name | Enable Mask [Bit0=StatusLed, Bit1=ErrorLed] |
| Data type | UNSIGNED32 |
| Access | read / write |
| PDO mapping | RX-PDO |
| Allowed values | |
| Preset value | FFFFFFFF _h |

3252h Digital Output Routing

Function

This object assigns a signal source to an output; this signal source can be controlled with 60FE_h. You can find details in chapter *Output Routing*.

Object description

| | |
|------------------|----------------------------|
| Index | 3252 _h |
| Object name | Digital Output Routing |
| Object Code | ARRAY |
| Data type | UNSIGNED16 |
| Savable | yes, category: application |
| Access | read only |
| PDO mapping | no |
| Allowed values | |
| Preset value | |
| Firmware version | FIR-v1540 |
| Change history | |

Value description

| | |
|----------------|-------------------|
| Subindex | 00 _h |
| Name | Number Of Entries |
| Data type | UNSIGNED8 |
| Access | read only |
| PDO mapping | no |
| Allowed values | |
| Preset value | 03 _h |

| | |
|----------------|--|
| Subindex | 01 _h |
| Name | Control Bit Of 60FE _h :1h And Source For Brake Output |
| Data type | UNSIGNED16 |
| Access | read / write |
| PDO mapping | TX-PDO |
| Allowed values | |
| Preset value | 1080 _h |

| | |
|----------------|--|
| Subindex | 02 _h |
| Name | Control Bit Of 60FEh:1h And Source For Output #1 |
| Data type | UNSIGNED16 |
| Access | read / write |
| PDO mapping | TX-PDO |
| Allowed values | |
| Preset value | 0010 _h |

| | |
|----------------|--|
| Subindex | 03 _h |
| Name | Control Bit Of 60FEh:1h And Source For Output #2 |
| Data type | UNSIGNED16 |
| Access | read / write |
| PDO mapping | TX-PDO |
| Allowed values | |
| Preset value | 0011 _h |

325Ah Outputs

Function

Use this object to control the digital outputs (alternative to [60FEh Digital Outputs](#)).

Object description

| | |
|------------------|---|
| Index | 325A _h |
| Object name | Outputs |
| Object Code | ARRAY |
| Data type | UNSIGNED16 |
| Savable | yes, category: application |
| Access | read only |
| PDO mapping | no |
| Allowed values | |
| Preset value | |
| Firmware version | FIR-v2339-B1048823 |
| Change history | Firmware version FIR-v2412-B1057638: entry "Savable" changed from "yes, category: communication" to "yes, category: application". |

Value description

| | |
|----------------|-------------------|
| Subindex | 00 _h |
| Name | Number Of Entries |
| Data type | UNSIGNED8 |
| Access | read only |
| PDO mapping | no |
| Allowed values | |
| Preset value | 01 _h |

| | |
|----------------|-------------------|
| Subindex | 01 _h |
| Name | User Outputs |
| Data type | UNSIGNED16 |
| Access | read / write |
| PDO mapping | no |
| Allowed values | |
| Preset value | 0000 _h |

Description

- Subindex 01_h:
 - Bits 0 to 6: Digital outputs 1 to 7 (exact number dependent on product)
 - Bit 7: Brake output (if present)

3273h Generic SPI Hardware Configuration

Function

See chapter [Generic SPI](#).

Object description

| | |
|------------------|------------------------------------|
| Index | 3273 _h |
| Object name | Generic SPI Hardware Configuration |
| Object Code | ARRAY |
| Data type | UNSIGNED32 |
| Savable | yes, category: application |
| Access | read only |
| PDO mapping | no |
| Allowed values | |
| Preset value | |
| Firmware version | FIR-v2213-B1029645 |
| Change history | |

Value description

| | |
|----------------|-------------------|
| Subindex | 00 _h |
| Name | Number Of Entries |
| Data type | UNSIGNED8 |
| Access | read only |
| PDO mapping | no |
| Allowed values | |
| Preset value | 01 _h |

| | |
|-----------|--------------------------|
| Subindex | 01 _h |
| Name | Hardware Feature Control |
| Data type | UNSIGNED32 |

| | |
|----------------|-----------------------|
| Access | read / write |
| PDO mapping | no |
| Allowed values | |
| Preset value | 00000000 _h |

3274h Generic SPI Mosi Data

Function

See chapter [Generic SPI](#).

Object description

| | |
|------------------|----------------------------|
| Index | 3274 _h |
| Object name | Generic SPI Mosi Data |
| Object Code | ARRAY |
| Data type | UNSIGNED8 |
| Savable | yes, category: application |
| Access | read / write |
| PDO mapping | no |
| Allowed values | |
| Preset value | |
| Firmware version | FIR-v2213-B1029645 |
| Change history | |

Value description

| | |
|----------------|----------------------------------|
| Subindex | 00 _h |
| Name | Length Of SPI Message To Be Sent |
| Data type | UNSIGNED8 |
| Access | read / write |
| PDO mapping | no |
| Allowed values | |
| Preset value | 00 _h |

| | |
|----------------|-------------------------------------|
| Subindex | 01 _h - 1F _h |
| Name | Generic SPI Mosi Data Byte #1 - #31 |
| Data type | UNSIGNED8 |
| Access | read / write |
| PDO mapping | no |
| Allowed values | |
| Preset value | 00 _h |

3275h Generic SPI Miso Data

Function

See chapter [Generic SPI](#).

Object description

| | |
|------------------|-----------------------|
| Index | 3275 _h |
| Object name | Generic SPI Miso Data |
| Object Code | ARRAY |
| Data type | UNSIGNED8 |
| Savable | no |
| Access | read only |
| PDO mapping | no |
| Allowed values | |
| Preset value | |
| Firmware version | FIR-v2213-B1029645 |
| Change history | |

Value description

| | |
|----------------|--------------------------------|
| Subindex | 00 _h |
| Name | Length Of Received SPI Message |
| Data type | UNSIGNED8 |
| Access | read only |
| PDO mapping | no |
| Allowed values | |
| Preset value | 00 _h |

| | |
|----------------|-------------------------------------|
| Subindex | 01 _h - 1F _h |
| Name | Generic SPI Miso Data Byte #1 - #31 |
| Data type | UNSIGNED8 |
| Access | read only |
| PDO mapping | no |
| Allowed values | |
| Preset value | 00 _h |

3320h Analog Input Values

Function

This object displays the instantaneous values of the analog inputs in user-defined units.

Object description

| | |
|-------|-------------------|
| Index | 3320 _h |
|-------|-------------------|

| | |
|------------------|---------------------|
| Object name | Analog Input Values |
| Object Code | ARRAY |
| Data type | INTEGER32 |
| Savable | no |
| Access | read only |
| PDO mapping | no |
| Allowed values | |
| Preset value | |
| Firmware version | FIR-v1426 |
| Change history | |

Value description

| | |
|----------------|-------------------------------|
| Subindex | 00 _h |
| Name | Number Of Analog Input Values |
| Data type | UNSIGNED8 |
| Access | read only |
| PDO mapping | no |
| Allowed values | |
| Preset value | 01 _h |

| | |
|----------------|-----------------------|
| Subindex | 01 _h |
| Name | Analog Input #1 Value |
| Data type | INTEGER32 |
| Access | read only |
| PDO mapping | TX-PDO |
| Allowed values | |
| Preset value | 00000000 _h |

Description

The user-defined units are made up of offset (3321_h) and scaling value (3322_h/ 3323_h). If both are still set to the default values, the value in 3320_h is specified in the *ADC Digits* unit.

Formula for converting from digits to the respective unit:

- Current input (if configurable): $x \text{ digits} * 20 \text{ mA} / 1023 \text{ digits}$

The following applies for the sub-entries:

- Subindex 00_h: Number of analog inputs
- Subindex 01_h: Analog value 1
- Subindex 02_h: Analog value 2 (if present)

3321h Analog Input Offsets

Function

Offset that is added to the read analog value (3220_h) before scaling (multiplier from object 3322 and divisor from object 3323_h).

Object description

| | |
|------------------|----------------------------|
| Index | 3321 _h |
| Object name | Analog Input Offsets |
| Object Code | ARRAY |
| Data type | INTEGER16 |
| Savable | yes, category: application |
| Access | read only |
| PDO mapping | no |
| Allowed values | |
| Preset value | |
| Firmware version | FIR-v2139-B1022383 |
| Change history | |

Value description

| | |
|----------------|--------------------------------|
| Subindex | 00 _h |
| Name | Number Of Analog Input Offsets |
| Data type | UNSIGNED8 |
| Access | read only |
| PDO mapping | no |
| Allowed values | |
| Preset value | 01 _h |

| | |
|----------------|------------------------|
| Subindex | 01 _h |
| Name | Analog Input #1 Offset |
| Data type | INTEGER16 |
| Access | read / write |
| PDO mapping | no |
| Allowed values | |
| Preset value | 0000 _h |

3322h Analog Input Numerators

Function

Value by which the read analog value (3320_h, 3321_h) is multiplied before it is written in object 3320_h.

Object description

| | |
|-------------|----------------------------|
| Index | 3322 _h |
| Object name | Analog Input Numerators |
| Object Code | ARRAY |
| Data type | INTEGER16 |
| Savable | yes, category: application |
| Access | read only |

| | |
|------------------|-----------|
| PDO mapping | no |
| Allowed values | |
| Preset value | |
| Firmware version | FIR-v1426 |
| Change history | |

Value description

| | |
|----------------|-----------------------------------|
| Subindex | 00 _h |
| Name | Number Of Analog Input Numerators |
| Data type | UNSIGNED8 |
| Access | read only |
| PDO mapping | no |
| Allowed values | |
| Preset value | 01 _h |

| | |
|----------------|---------------------------|
| Subindex | 01 _h |
| Name | Analog Input #1 Numerator |
| Data type | INTEGER16 |
| Access | read / write |
| PDO mapping | no |
| Allowed values | |
| Preset value | 7850 _h |

Description

The subindices contain:

- Subindex 01_h: Multiplier for analog input 1
- Subindex 02_h: Multiplier for analog input 2 (if present)

3323h Analog Input Denominators

Function

Value by which the read analog value (3320_h+ 3321_h) is divided before it is written in object 3320_h.

Object description

| | |
|----------------|----------------------------|
| Index | 3323 _h |
| Object name | Analog Input Denominators |
| Object Code | ARRAY |
| Data type | INTEGER16 |
| Savable | yes, category: application |
| Access | read only |
| PDO mapping | no |
| Allowed values | |
| Preset value | |

| | |
|------------------|-------------------|
| Firmware version | FIR-v1926-B648637 |
| Change history | |

Value description

| | |
|----------------|-------------------------------------|
| Subindex | 00 _h |
| Name | Number Of Analog Input Denominators |
| Data type | UNSIGNED8 |
| Access | read only |
| PDO mapping | no |
| Allowed values | |
| Preset value | 01 _h |

| | |
|----------------|-----------------------------|
| Subindex | 01 _h |
| Name | Analog Input #1 Denominator |
| Data type | INTEGER16 |
| Access | read / write |
| PDO mapping | no |
| Allowed values | |
| Preset value | 0FFF _h |

Description

The subindices contain:

- Subindex 01_h: Divisor for analog input 1
- Subindex 02_h: Divisor for analog input 2 (if present)

3380h Feedback Sensorless

Function

Contains measurement and configuration values that are necessary for the sensorless control and field weakening in Closed-Loop.

Object description

| | |
|------------------|-----------------------|
| Index | 3380 _h |
| Object name | Feedback Sensorless |
| Object Code | ARRAY |
| Data type | UNSIGNED32 |
| Savable | yes, category: tuning |
| Access | read only |
| PDO mapping | RX-PDO |
| Allowed values | |
| Preset value | |
| Firmware version | FIR-v2013-B726332 |

Change history Firmware version FIR-v2013-B726332: The number of entries was changed from 7 to 6.

Value description

| | |
|----------------|-------------------|
| Subindex | 00 _h |
| Name | Number Of Entries |
| Data type | UNSIGNED8 |
| Access | read only |
| PDO mapping | RX-PDO |
| Allowed values | |
| Preset value | 05 _h |

| | |
|----------------|--|
| Subindex | 01 _h |
| Name | Resistance [Ohm] |
| Data type | UNSIGNED32 |
| Access | read / write |
| PDO mapping | RX-PDO |
| Allowed values | |
| Preset value | <ul style="list-style-type: none"> ■ PD1-C281S15-E-20-2: 3FA66666_h ■ PD1-C281S15-E-20-5: 3FA66666_h ■ PD1-C281S15-E-65-2: 3FA66666_h ■ PD1-C281S15-E-65-5: 3FA66666_h ■ PD1-C281S15-E-OF-2: 3FA66666_h ■ PD1-C281S15-E-OF-5: 3FA66666_h ■ PD1-C281L15-E-20-2: 3FF33333_h ■ PD1-C281L15-E-20-5: 3FF33333_h ■ PD1-C281L15-E-65-2: 3FF33333_h ■ PD1-C281L15-E-65-5: 3FF33333_h ■ PD1-C281L15-E-OF-2: 3FF33333_h ■ PD1-C281L15-E-OF-5: 3FF33333_h |

| | |
|----------------|--|
| Subindex | 02 _h |
| Name | Inductance [H] |
| Data type | UNSIGNED32 |
| Access | read / write |
| PDO mapping | RX-PDO |
| Allowed values | |
| Preset value | <ul style="list-style-type: none"> ■ PD1-C281S15-E-20-2: 3A83126F_h ■ PD1-C281S15-E-20-5: 3A83126F_h ■ PD1-C281S15-E-65-2: 3A83126F_h ■ PD1-C281S15-E-65-5: 3A83126F_h ■ PD1-C281S15-E-OF-2: 3A83126F_h ■ PD1-C281S15-E-OF-5: 3A83126F_h ■ PD1-C281L15-E-20-2: 3AF9096C_h ■ PD1-C281L15-E-20-5: 3AF9096C_h |

- PD1-C281L15-E-65-2: 3AF9096C_h
- PD1-C281L15-E-65-5: 3AF9096C_h
- PD1-C281L15-E-OF-2: 3AF9096C_h
- PD1-C281L15-E-OF-5: 3AF9096C_h

| | |
|----------------|--|
| Subindex | 03 _h |
| Name | Magnetic Flux [Vs] |
| Data type | UNSIGNED32 |
| Access | read / write |
| PDO mapping | RX-PDO |
| Allowed values | |
| Preset value | <ul style="list-style-type: none"> ■ PD1-C281S15-E-20-2: 3A5E6FE2_h ■ PD1-C281S15-E-20-5: 3A5E6FE2_h ■ PD1-C281S15-E-65-2: 3A5E6FE2_h ■ PD1-C281S15-E-65-5: 3A5E6FE2_h ■ PD1-C281S15-E-OF-2: 3A5E6FE2_h ■ PD1-C281S15-E-OF-5: 3A5E6FE2_h ■ PD1-C281L15-E-20-2: 3ADE6FE2_h ■ PD1-C281L15-E-20-5: 3ADE6FE2_h ■ PD1-C281L15-E-65-2: 3ADE6FE2_h ■ PD1-C281L15-E-65-5: 3ADE6FE2_h ■ PD1-C281L15-E-OF-2: 3ADE6FE2_h ■ PD1-C281L15-E-OF-5: 3ADE6FE2_h |

| | |
|----------------|-----------------------|
| Subindex | 04 _h |
| Name | Switch On Speed [rpm] |
| Data type | UNSIGNED32 |
| Access | read / write |
| PDO mapping | RX-PDO |
| Allowed values | |
| Preset value | 00000078 _h |

| | |
|----------------|------------------------|
| Subindex | 05 _h |
| Name | Switch Off Speed [rpm] |
| Data type | UNSIGNED32 |
| Access | read / write |
| PDO mapping | RX-PDO |
| Allowed values | |
| Preset value | 00000064 _h |

Description

The subindices have the following function:

- 01_h: Winding resistance. Float value, shown here as UNSIGNED32. Is determined by [Auto setup](#).
- 02_h: Winding inductance. Float value, shown here as UNSIGNED32. Is determined by [Auto setup](#).
- 03_h: Interlinking flux. Float value, shown here as UNSIGNED32. Is determined by [Auto setup](#).

- 04_h: Switch-on speed in RPM. *Closed loop (sensorless)* is activated above this speed if no sensors were detected by Auto setup.
- 05_h: Switch-off speed in RPM. *Closed loop (sensorless)* is deactivated below this speed if no sensors were detected by Auto setup.

33A0h Feedback Incremental A/B/I 1

Function

Contains configuration values for the first incremental encoder. The values are determined by the Auto setup.

Object description

| | |
|------------------|------------------------------|
| Index | 33A0 _h |
| Object name | Feedback Incremental A/B/I 1 |
| Object Code | ARRAY |
| Data type | UNSIGNED16 |
| Savable | yes, category: tuning |
| Access | read only |
| PDO mapping | RX-PDO |
| Allowed values | |
| Preset value | |
| Firmware version | FIR-v1738-B501312 |
| Change history | |

Value description

| | |
|----------------|-------------------|
| Subindex | 00 _h |
| Name | Number Of Entries |
| Data type | UNSIGNED8 |
| Access | read only |
| PDO mapping | RX-PDO |
| Allowed values | |
| Preset value | 03 _h |

| | |
|----------------|-------------------|
| Subindex | 01 _h |
| Name | Configuration |
| Data type | UNSIGNED16 |
| Access | read / write |
| PDO mapping | RX-PDO |
| Allowed values | |
| Preset value | 0001 _h |

| | |
|-----------|-----------------|
| Subindex | 02 _h |
| Name | Alignment |
| Data type | UNSIGNED16 |
| Access | read / write |

| | |
|----------------|-------------------|
| PDO mapping | RX-PDO |
| Allowed values | |
| Preset value | 0000 _h |

| | |
|----------------|-------------------|
| Subindex | 03 _h |
| Name | Latency [ns] |
| Data type | UNSIGNED16 |
| Access | read / write |
| PDO mapping | RX-PDO |
| Allowed values | |
| Preset value | 0000 _h |

Description

The subindices have the following function:

- 01_h (Configuration): The following bits have a meaning:
 - Bit 0: Value = "0": The encoder does not have an index. Value = "1": Encoder index exists and is to be used.
- 02_h (Alignment): This value specifies the offset between the index of the encoder and the rotor's magnets. The exact determination is possible via [auto setup](#). The presence of this value is necessary for *closed-loop* mode with encoder.
- 03_h (Latency): Here you can enter the latency of used encoder.

3700h Deviation Error Option Code

Function

The object contains the action that is to be executed if a following or slippage error is triggered.

Object description

| | |
|------------------|--|
| Index | 3700 _h |
| Object name | Deviation Error Option Code |
| Object Code | VARIABLE |
| Data type | INTEGER16 |
| Savable | yes, category: application |
| Access | read / write |
| PDO mapping | no |
| Allowed values | |
| Preset value | FFFF _h |
| Firmware version | FIR-v1426 |
| Change history | Firmware version FIR-v1738-B501312: "Object Name" entry changed from "Following Error Option Code" to "Deviation Error Option Code". |

Description

| Value | Description |
|---------------|---|
| -32768 ... -2 | Reserved |
| -1 | no reaction |
| 0 | Switch off driver without deceleration ramp; drive function blocked – motor can turn freely |
| 1 | Braking with <i>slow down ramp</i> (braking deceleration depending on operating mode) |
| 2 | Braking with <i>quick stop ramp</i> (6085 _h) |
| 3 ... 32767 | reserved |

3701h Limit Switch Error Option Code

Function

If a limit switch is triggered, the limit switch position is stored internally, bit 7 (*Warning*) in 6041_h (*statusword*) is set and the *CiA 402 Power State Machine* is set to the *Quick Stop Active* state. The action stored in this object is executed in the process. See chapter Limitation of the range of motion.

Object description

| | |
|------------------|--------------------------------|
| Index | 3701 _h |
| Object name | Limit Switch Error Option Code |
| Object Code | VARIABLE |
| Data type | INTEGER16 |
| Savable | yes, category: application |
| Access | read / write |
| PDO mapping | no |
| Allowed values | |
| Preset value | FFFF _h |
| Firmware version | FIR-v1748-B538662 |
| Change history | |

Description

| Value in object 3701 _h | Description |
|-----------------------------------|--|
| -2 | No reaction, discard the limit switch position |
| -1 (factory settings) | No reaction (e. g., to execute a homing operation) except noting the limit switch position |
| 0 | Switch off driver without deceleration ramp; drive function blocked – motor can turn freely (<i>Switch on disabled</i> state) |
| 1 | Braking with <i>slow down ramp</i> (deceleration ramp depending on operating mode) and subsequent state change to <i>Switch on disabled</i> |
| 2 | Braking with <i>quick stop ramp</i> and subsequent state change to <i>Switch on disabled</i> |
| 5 | Braking with <i>slow down ramp</i> (deceleration ramp depending on operating mode) and subsequent state change to <i>Quick stop active</i> ; |

| Value in object 3701 _h | Description |
|-----------------------------------|--|
| 6 | control does not switch off and the motor remains energized. You can switch back to the <i>Operation enabled</i> state. Braking with <i>quick stop ramp</i> and subsequent state change to <i>Quick Stop Active</i> ; control does not switch off and the motor remains energized. You can switch back to the <i>Operation enabled</i> state. |

4012h HW Information

Function

This object contains information about the hardware.

Object description

| | |
|------------------|-------------------|
| Index | 4012 _h |
| Object name | HW Information |
| Object Code | ARRAY |
| Data type | UNSIGNED32 |
| Savable | no |
| Access | read only |
| PDO mapping | no |
| Allowed values | |
| Preset value | |
| Firmware version | FIR-v1540 |
| Change history | |

Value description

| | |
|----------------|-------------------|
| Subindex | 00 _h |
| Name | Number Of Entries |
| Data type | UNSIGNED8 |
| Access | read only |
| PDO mapping | no |
| Allowed values | |
| Preset value | 01 _h |

| | |
|----------------|-----------------------|
| Subindex | 01 _h |
| Name | EEPROM Size In Bytes |
| Data type | UNSIGNED32 |
| Access | read only |
| PDO mapping | no |
| Allowed values | |
| Preset value | 00000000 _h |

Description

Subindex 01: Contains the size of the connected EEPROM in bytes. The value "0" means that no EEPROM is connected.

4013h HW Configuration

Function

This object is used to set certain hardware configurations.

Object description

| | |
|------------------|----------------------------|
| Index | 4013 _h |
| Object name | HW Configuration |
| Object Code | ARRAY |
| Data type | UNSIGNED32 |
| Savable | yes, category: application |
| Access | read only |
| PDO mapping | no |
| Allowed values | |
| Preset value | |
| Firmware version | FIR-v1540 |
| Change history | |

Value description

| | |
|----------------|-------------------|
| Subindex | 00 _h |
| Name | Number Of Entries |
| Data type | UNSIGNED8 |
| Access | read only |
| PDO mapping | no |
| Allowed values | |
| Preset value | 01 _h |

| | |
|----------------|-----------------------|
| Subindex | 01 _h |
| Name | HW Configuration #1 |
| Data type | UNSIGNED32 |
| Access | read / write |
| PDO mapping | no |
| Allowed values | |
| Preset value | 00000000 _h |

Description

4014h Operating Conditions

Function

This object is used to read out the current environment values for the controller.

Object description

| | |
|------------------|---|
| Index | 4014 _h |
| Object name | Operating Conditions |
| Object Code | ARRAY |
| Data type | INTEGER32 |
| Savable | no |
| Access | read only |
| PDO mapping | no |
| Allowed values | |
| Preset value | |
| Firmware version | FIR-v1540 |
| Change history | <p>Firmware version FIR-v1650-B472161: "Access" table entry for subindex 01 changed from "read/write" to "read only".</p> <p>Firmware version FIR-v1650-B472161: "Access" table entry for subindex 02 changed from "read/write" to "read only".</p> <p>Firmware version FIR-v1650-B472161: "Name" entry changed from "Temperature PCB [d?C]" to "Temperature PCB [Celsius * 10]".</p> <p>Firmware version FIR-v1650-B472161: "Access" table entry for subindex 03 changed from "read/write" to "read only".</p> <p>Firmware version FIR-v1738-B501312: The number of entries was changed from 4 to 6.</p> |

Value description

| | |
|----------------|-----------------------|
| Subindex | 00 _h |
| Name | Number Of Entries |
| Data type | UNSIGNED8 |
| Access | read only |
| PDO mapping | no |
| Allowed values | |
| Preset value | 05 _h |
| Subindex | 01 _h |
| Name | Voltage UB Power [mV] |
| Data type | INTEGER32 |
| Access | read only |
| PDO mapping | TX-PDO |
| Allowed values | |
| Preset value | 00000000 _h |

| | |
|----------------|-----------------------|
| Subindex | 02 _h |
| Name | Voltage UB Logic [mV] |
| Data type | INTEGER32 |
| Access | read only |
| PDO mapping | TX-PDO |
| Allowed values | |
| Preset value | 00000000 _h |

| | |
|----------------|--------------------------------|
| Subindex | 03 _h |
| Name | Temperature PCB [Celsius * 10] |
| Data type | INTEGER32 |
| Access | read only |
| PDO mapping | TX-PDO |
| Allowed values | |
| Preset value | 00000000 _h |

| | |
|----------------|----------------------------------|
| Subindex | 04 _h |
| Name | Temperature Motor [Celsius * 10] |
| Data type | INTEGER32 |
| Access | read only |
| PDO mapping | TX-PDO |
| Allowed values | |
| Preset value | 00000000 _h |

| | |
|----------------|---|
| Subindex | 05 _h |
| Name | Temperature Microcontroller Chip [Celsius * 10] |
| Data type | INTEGER32 |
| Access | read only |
| PDO mapping | TX-PDO |
| Allowed values | |
| Preset value | 00000000 _h |

Description

The subindices contain:

- 01_h: Current voltage supply voltage in [mV]
- 02_h:
- 03_h: Current temperature of the control board in [d°C] (tenths of degree)
- 04_h: Reserves
- 05_h: Current temperature of the processor in [d°C] (tenths of degree)

4015h Special Drive Modes

Function

With this object, you can switch the *special drive modes* off or on. See chapter .

Object description

| | |
|------------------|----------------------------|
| Index | 4015 _h |
| Object name | Special Drive Modes |
| Object Code | ARRAY |
| Data type | UNSIGNED8 |
| Savable | yes, category: application |
| Access | read only |
| PDO mapping | no |
| Allowed values | |
| Preset value | |
| Firmware version | FIR-v1738-B501312 |
| Change history | |

Value description

| | |
|----------------|-------------------|
| Subindex | 00 _h |
| Name | Number Of Entries |
| Data type | UNSIGNED8 |
| Access | read only |
| PDO mapping | no |
| Allowed values | |
| Preset value | 02 _h |

| | |
|----------------|----------------------------------|
| Subindex | 01 _h |
| Name | Special Drive Mode Configuration |
| Data type | UNSIGNED8 |
| Access | read / write |
| PDO mapping | no |
| Allowed values | |
| Preset value | 00 _h |

| | |
|----------------|-----------------------------|
| Subindex | 02 _h |
| Name | Virtual Config Switch Value |
| Data type | UNSIGNED8 |
| Access | read / write |
| PDO mapping | no |
| Allowed values | |
| Preset value | 00 _h |

Description

The subindices have the following functions:

- 01_h:
 - Value = "0"_h: The *special drive modes* are switched off

- Value="2"_h: The *special drive modes* are switched on and the mode is set in subindex 02_h.
- 02_h: Defines the used mode.

4016h Factory Setup

Function

This object indicates whether Auto setup was executed in production.

Object description

| | |
|------------------|--|
| Index | 4016 _h |
| Object name | Factory Setup |
| Object Code | ARRAY |
| Data type | UNSIGNED32 |
| Savable | no |
| Access | read only |
| PDO mapping | no |
| Allowed values | |
| Preset value | |
| Firmware version | FIR-v1738-B501312 |
| Change history | Firmware version FIR-v2013-B726332: "Access" table entry for subindex 01 changed from "read/write" to "read only". |

Value description

| | |
|----------------|--------------------------|
| Subindex | 00 _h |
| Name | Number Of Entries |
| Data type | UNSIGNED8 |
| Access | read only |
| PDO mapping | no |
| Allowed values | |
| Preset value | 02 _h |
| Subindex | 01 _h |
| Name | Factory Setup Successful |
| Data type | UNSIGNED32 |
| Access | read only |
| PDO mapping | no |
| Allowed values | |
| Preset value | 00000000 _h |
| Subindex | 02 _h |
| Name | Factory Setup Status |
| Data type | UNSIGNED32 |
| Access | read only |

| | |
|----------------|-----------------------|
| PDO mapping | no |
| Allowed values | |
| Preset value | 00000000 _h |

Description

Valid values for subindex 01_h:

- Value = "0": *Auto setup* was not executed.
- Value = "1": *Auto setup* was executed.

4040h Drive Serial Number

Function

This object contains the serial number of the controller.

Object description

| | |
|------------------|---------------------|
| Index | 4040 _h |
| Object name | Drive Serial Number |
| Object Code | VARIABLE |
| Data type | VISIBLE_STRING |
| Savable | no |
| Access | read only |
| PDO mapping | no |
| Allowed values | |
| Preset value | 0 |
| Firmware version | FIR-v1450 |
| Change history | |

4041h Device Id

Function

This object contains the ID of the device.

Object description

| | |
|------------------|-------------------|
| Index | 4041 _h |
| Object name | Device Id |
| Object Code | VARIABLE |
| Data type | OCTET_STRING |
| Savable | no |
| Access | read only |
| PDO mapping | no |
| Allowed values | |
| Preset value | 0 |
| Firmware version | FIR-v1540 |
| Change history | |

4042h Bootloader Infos

Object description

| | |
|------------------|-------------------|
| Index | 4042 _h |
| Object name | Bootloader Infos |
| Object Code | ARRAY |
| Data type | UNSIGNED32 |
| Savable | no |
| Access | read only |
| PDO mapping | no |
| Allowed values | |
| Preset value | |
| Firmware version | FIR-v2013-B726332 |
| Change history | |

Value description

| | |
|----------------|-------------------|
| Subindex | 00 _h |
| Name | Number Of Entries |
| Data type | UNSIGNED8 |
| Access | read only |
| PDO mapping | no |
| Allowed values | |
| Preset value | 03 _h |

| | |
|----------------|-----------------------|
| Subindex | 01 _h |
| Name | Bootloader Version |
| Data type | UNSIGNED32 |
| Access | read only |
| PDO mapping | no |
| Allowed values | |
| Preset value | 00000000 _h |

| | |
|----------------|-------------------------------|
| Subindex | 02 _h |
| Name | Bootloader Supported Fieldbus |
| Data type | UNSIGNED32 |
| Access | read only |
| PDO mapping | no |
| Allowed values | |
| Preset value | 00000000 _h |

| | |
|----------|---------------------|
| Subindex | 03 _h |
| Name | Bootloader Hw-group |

| | |
|----------------|-----------------------|
| Data type | UNSIGNED32 |
| Access | read only |
| PDO mapping | no |
| Allowed values | |
| Preset value | 00000000 _h |

Description

The subindices have the following functions:

- 01_h: Version of the boot loader. The 4 most significant bytes contain the main version number; the 4 least significant bytes contain the minor version number. Example for version 4.2: 00040002_h
- 02_h: Fieldbuses supported by the boot loader. The bits have the same function as the bits of object 2101h Fieldbus Module Availability.

6007h Abort Connection Option Code

Function

If an error (watchdog, heartbeat, etc.) occurs on the bus, the controller automatically switches to the SAFEOPERATIONAL state. With this object, you can set the reaction.

Object description

| | |
|------------------|------------------------------|
| Index | 6007 _h |
| Object name | Abort Connection Option Code |
| Object Code | VARIABLE |
| Data type | INTEGER16 |
| Savable | yes, category: application |
| Access | read / write |
| PDO mapping | no |
| Allowed values | |
| Preset value | 0001 _h |
| Firmware version | FIR-v2013-B726332 |
| Change history | |

Description

You can set the following reactions:

| Value | Reaction |
|-------|--|
| -1 | The controller (slave) sets all input values (RX-PDO) to the value "0". This also sets the object 6040 _h (controlword) to "0", which causes the motor to coast to a stop. |
| 0 | no reaction |
| 1 | <i>Fault</i> : The action stored in object 605E _h is executed. |
| 2 | <i>Disable voltage</i> : Transition to the <i>Switched on disabled</i> state without halt motion reaction (the motor coasts to a stop) |
| 3 | <i>Quick stop</i> : The action stored in object 605A _h is executed. |

603Fh Error Code

Function

This object returns the error code of the last error that occurred.

It corresponds to the lower 16 bits of object 1003_h. For the description of the error codes, refer to object 1003_h.

Object description

| | |
|------------------|-------------------|
| Index | 603F _h |
| Object name | Error Code |
| Object Code | VARIABLE |
| Data type | UNSIGNED16 |
| Savable | no |
| Access | read only |
| PDO mapping | TX-PDO |
| Allowed values | |
| Preset value | 0000 _h |
| Firmware version | FIR-v1426 |
| Change history | |

Description

For the meaning of the error, see object 1003_h (Pre-defined Error Field).

If the error is reset by setting bit 7 in 6040h Controlword, this object is also automatically reset to "0".

6040h Controlword

Function

This object controls the CiA 402 Power State Machine.

Object description

| | |
|------------------|--|
| Index | 6040 _h |
| Object name | Controlword |
| Object Code | VARIABLE |
| Data type | UNSIGNED16 |
| Savable | yes, category: application |
| Access | read / write |
| PDO mapping | RX-PDO |
| Allowed values | |
| Preset value | 0000 _h |
| Firmware version | FIR-v1426 |
| Change history | Firmware version FIR-v1626: "Savable" entry changed from "no" to "yes, category: application". |

Description

Parts of the object are, with respect to function, dependent on the currently selected mode.

| | | | | | | | | | | | | | | | |
|----|----|----|----|----|----|-----|------|----|---|---------|---|----|----|----|----|
| 15 | 14 | 13 | 12 | 11 | 10 | 9 | 8 | 7 | 6 | 5 | 4 | 3 | 2 | 1 | 0 |
| | | | | | | OMS | HALT | FR | | OMS [3] | | EO | QS | EV | SO |

SO (Switched On)

Value = "1": Switches to the "Switched on" state

EV (Enable Voltage)

Value = "1": Switches to the "Enable voltage" state

QS (Quick Stop)

Value = "0": Switches to the "Quick stop" state

EO (Enable Operation)

Value = "1": Switches to the "Enable operation" state

OMS (Operation Mode Specific)

Meaning is dependent on the selected operating mode

FR (Fault Reset)

Resets an error or a warning (if possible)

HALT

Value = "1": Triggers a halt; valid in the following modes:

- Profile Position
- Velocity
- Profile Velocity
- Profile Torque
- Interpolated Position Mode

6041h Statusword

Function

This object returns information about the status of the CiA 402 Power State Machine.

Object description

| | |
|------------------|-------------------|
| Index | 6041 _h |
| Object name | Statusword |
| Object Code | VARIABLE |
| Data type | UNSIGNED16 |
| Savable | no |
| Access | read only |
| PDO mapping | TX-PDO |
| Allowed values | |
| Preset value | 0000 _h |
| Firmware version | FIR-v1426 |
| Change history | |

Description

Parts of the object are, with respect to function, dependent on the currently selected mode. Refer to the corresponding section in chapter [operating modes](#).

| | | | | | | | | | | | | | | | |
|-----|----|---------|-----|------|-----|------|------|-----|----|----|-------|----|----|------|---|
| 15 | 14 | 13 | 12 | 11 | 10 | 9 | 8 | 7 | 6 | 5 | 4 | 3 | 2 | 1 | 0 |
| CLA | | OMS [2] | ILA | TARG | REM | SYNC | WARN | SOD | QS | VE | FAULT | OE | SO | RTSO | |

RTSO (Ready To Switch On)

Value = "1": Controller is in the "Ready to switch on" state

SO (Switched On)

Value = "1": Controller is in the "Switched on" state

OE (Operation Enabled)

Value = "1": Controller is in the "Operation enabled" state

FAULT

Error occurred (see [1003_h](#))

VE (Voltage Enabled)

Voltage applied

QS (Quick Stop)

Value = "0": Controller is in the "Quick stop" state

SOD (Switched On Disabled)

Value = "1": Controller is in the "Switched on disabled" state

WARN (Warning)

Value = "1": Warning

SYNC (synchronization)

Value = "1": Controller is in sync with the fieldbus; value = "0": Controller is not in sync with the fieldbus

REM (Remote)

Remote (value of the bit is always "1")

TARG

Target reached. The value stays after an operation mode change at "1", until a new target is commanded.

ILA (Internal Limit Active)

Limit exceeded

OMS (Operation Mode Specific)

Meaning is dependent on the selected operating mode

CLA (Closed Loop Active)

Value = "1": The controller is in the *Operation enabled* state and the Closed-Loop is activated.

Listed in the following table are the bit masks that break down the state of the controller.

| Statusword (6041 _h) | State |
|---------------------------------|------------------------|
| xxxx xxxx x0xx 0000 | Not ready to switch on |
| xxxx xxxx x1xx 0000 | Switch on disabled |

| Statusword (6041 _h) | State |
|---------------------------------|-----------------------|
| xxxx xxxx x01x 0001 | Ready to switch on |
| xxxx xxxx x01x 0011 | Switched on |
| xxxx xxxx x01x 0111 | Operation enabled |
| xxxx xxxx x00x 0111 | Quick stop active |
| xxxx xxxx x0xx 1111 | Fault reaction active |
| xxxx xxxx x0xx 1000 | Fault |

6042h VI Target Velocity

Function

Specifies the target speed in user-defined units for Velocity mode.

Object description

| | |
|------------------|--|
| Index | 6042 _h |
| Object name | VI Target Velocity |
| Object Code | VARIABLE |
| Data type | INTEGER16 |
| Savable | yes, category: application |
| Access | read / write |
| PDO mapping | RX-PDO |
| Allowed values | |
| Preset value | 0000 _h |
| Firmware version | FIR-v1426 |
| Change history | Firmware version FIR-v1626: "Savable" entry changed from "no" to "yes, category: application". |

6043h VI Velocity Demand

Function

Speed specification in user-defined units for the controller in Velocity mode.

Object description

| | |
|------------------|--------------------|
| Index | 6043 _h |
| Object name | VI Velocity Demand |
| Object Code | VARIABLE |
| Data type | INTEGER16 |
| Savable | no |
| Access | read only |
| PDO mapping | TX-PDO |
| Allowed values | |
| Preset value | 0000 _h |
| Firmware version | FIR-v1426 |
| Change history | |

6044h VI Velocity Actual Value

Function

Specifies the current actual speed in user-defined units in Velocity mode.

Object description

| | |
|------------------|--------------------------|
| Index | 6044 _h |
| Object name | VI Velocity Actual Value |
| Object Code | VARIABLE |
| Data type | INTEGER16 |
| Savable | no |
| Access | read only |
| PDO mapping | TX-PDO |
| Allowed values | |
| Preset value | 0000 _h |
| Firmware version | FIR-v1426 |
| Change history | |

6046h VI Velocity Min Max Amount

Function

This object can be used to set the minimum speed and maximum speed in user-defined units.

Object description

| | |
|------------------|----------------------------|
| Index | 6046 _h |
| Object name | VI Velocity Min Max Amount |
| Object Code | ARRAY |
| Data type | UNSIGNED32 |
| Savable | yes, category: application |
| Firmware version | FIR-v1426 |
| Change history | |

Value description

| | |
|----------------|-------------------|
| Subindex | 00 _h |
| Name | Number Of Entries |
| Data type | UNSIGNED8 |
| Access | read only |
| PDO mapping | no |
| Allowed values | |
| Preset value | 02 _h |
| Subindex | 01 _h |

| | |
|----------------|-----------------------|
| Name | Min Amount |
| Data type | UNSIGNED32 |
| Access | read / write |
| PDO mapping | RX-PDO |
| Allowed values | |
| Preset value | 00000000 _h |

| | |
|----------------|-----------------------|
| Subindex | 02 _h |
| Name | Max Amount |
| Data type | UNSIGNED32 |
| Access | read / write |
| PDO mapping | RX-PDO |
| Allowed values | |
| Preset value | 00007530 _h |

Description

Subindex 1 contains the minimum speed.

Subindex 2 contains the maximum speed.

If the value of the target speed (object 6042_h) specified here is less than the minimum speed, the minimum speed applies and bit 11 (Internal Limit Reached) in 6041_h Statusword_h is set.

A target speed greater than the maximum speed sets the speed to the maximum speed and bit 11 (Internal Limit Reached) in 6041_h Statusword_h is set.

6048h VI Velocity Acceleration

Function

Sets the acceleration ramp in Velocity Mode (see [Velocity](#)).

Object description

| | |
|------------------|------------------------------------|
| Index | 6048 _h |
| Object name | VI Velocity Acceleration |
| Object Code | RECORD |
| Data type | VELOCITY_ACCELERATION_DECELERATION |
| Savable | yes, category: application |
| Firmware version | FIR-v1426 |
| Change history | |

Value description

| | |
|-------------|-------------------|
| Subindex | 00 _h |
| Name | Number Of Entries |
| Data type | UNSIGNED8 |
| Access | read only |
| PDO mapping | no |

| | |
|----------------|-----------------------|
| Allowed values | |
| Preset value | 02 _h |
| <hr/> | |
| Subindex | 01 _h |
| Name | Delta Speed |
| Data type | UNSIGNED32 |
| Access | read / write |
| PDO mapping | RX-PDO |
| Allowed values | |
| Preset value | 000001F4 _h |
| <hr/> | |
| Subindex | 02 _h |
| Name | Delta Time |
| Data type | UNSIGNED16 |
| Access | read / write |
| PDO mapping | RX-PDO |
| Allowed values | |
| Preset value | 0001 _h |

Description

The acceleration is specified as a fraction in user-defined units:

Speed change per change in time.

Subindex 01_h: Contains the change in speed.

Subindex 02_h: Contains the change in time.

6049h VI Velocity Deceleration

Function

Sets the deceleration (deceleration ramp) in Velocity Mode (see [Velocity](#)).

Object description

| | |
|------------------|------------------------------------|
| Index | 6049 _h |
| Object name | VI Velocity Deceleration |
| Object Code | RECORD |
| Data type | VELOCITY_ACCELERATION_DECELERATION |
| Savable | yes, category: application |
| Firmware version | FIR-v1426 |
| Change history | |

Value description

| | |
|----------|-------------------|
| Subindex | 00 _h |
| Name | Number Of Entries |

| | |
|----------------|-----------------|
| Data type | UNSIGNED8 |
| Access | read only |
| PDO mapping | no |
| Allowed values | |
| Preset value | 02 _h |

| | |
|----------------|-----------------------|
| Subindex | 01 _h |
| Name | Delta Speed |
| Data type | UNSIGNED32 |
| Access | read / write |
| PDO mapping | RX-PDO |
| Allowed values | |
| Preset value | 000001F4 _h |

| | |
|----------------|-------------------|
| Subindex | 02 _h |
| Name | Delta Time |
| Data type | UNSIGNED16 |
| Access | read / write |
| PDO mapping | RX-PDO |
| Allowed values | |
| Preset value | 0001 _h |

Description

The deceleration is specified as a fraction in user-defined units:

Speed change per change in time.

Subindex 01_h: Contains the change in speed.

Subindex 02_h: Contains the change in time.

604Ah VI Velocity Quick Stop

Function

This object defines the deceleration (deceleration ramp) if the Quick Stop state is initiated in velocity mode.

Object description

| | |
|------------------|------------------------------------|
| Index | 604A _h |
| Object name | VI Velocity Quick Stop |
| Object Code | RECORD |
| Data type | VELOCITY_ACCELERATION_DECELERATION |
| Savable | yes, category: application |
| Firmware version | FIR-v1426 |
| Change history | |

Value description

| | |
|----------------|-------------------|
| Subindex | 00 _h |
| Name | Number Of Entries |
| Data type | UNSIGNED8 |
| Access | read only |
| PDO mapping | no |
| Allowed values | |
| Preset value | 02 _h |

| | |
|----------------|-----------------------|
| Subindex | 01 _h |
| Name | Delta Speed |
| Data type | UNSIGNED32 |
| Access | read / write |
| PDO mapping | RX-PDO |
| Allowed values | |
| Preset value | 00001388 _h |

| | |
|----------------|-------------------|
| Subindex | 02 _h |
| Name | Delta Time |
| Data type | UNSIGNED16 |
| Access | read / write |
| PDO mapping | RX-PDO |
| Allowed values | |
| Preset value | 0001 _h |

Description

The deceleration is specified as a fraction in user-defined units:

Speed change per change in time.

Subindex 01_h: Contains the change in speed.

Subindex 02_h: Contains the change in time.

604Ch VI Dimension Factor

Function

The unit for speed values is defined here for the objects associated with velocity mode.

Object description

| | |
|------------------|----------------------------|
| Index | 604C _h |
| Object name | VI Dimension Factor |
| Object Code | ARRAY |
| Data type | INTEGER32 |
| Savable | yes, category: application |
| Firmware version | FIR-v1426 |

Change history

Value description

| | |
|----------------|-------------------|
| Subindex | 00 _h |
| Name | Number Of Entries |
| Data type | UNSIGNED8 |
| Access | read only |
| PDO mapping | no |
| Allowed values | |
| Preset value | 02 _h |

| | |
|----------------|-------------------------------|
| Subindex | 01 _h |
| Name | VI Dimension Factor Numerator |
| Data type | INTEGER32 |
| Access | read / write |
| PDO mapping | RX-PDO |
| Allowed values | |
| Preset value | 00000001 _h |

| | |
|----------------|---------------------------------|
| Subindex | 02 _h |
| Name | VI Dimension Factor Denominator |
| Data type | INTEGER32 |
| Access | read / write |
| PDO mapping | RX-PDO |
| Allowed values | |
| Preset value | 00000001 _h |

Description

Subindex 1 contains the numerator (multiplier) and subindex 2 contains the denominator (divisor) with which the internal speed values are converted to revolutions per minute. If, for example, subindex 1 is set to the value "60" and subindex 2 is set to the value "1", the speed is specified in revolutions per second (60 revolutions per 1 minute).

605Ah Quick Stop Option Code**Function**

The object contains the action that is to be executed on a transition of the [CiA 402 Power State Machine](#) to the *Quick Stop active* state.

Object description

| | |
|-------------|------------------------|
| Index | 605A _h |
| Object name | Quick Stop Option Code |
| Object Code | VARIABLE |

| | |
|------------------|----------------------------|
| Data type | INTEGER16 |
| Savable | yes, category: application |
| Access | read / write |
| PDO mapping | no |
| Allowed values | |
| Preset value | 0002 _h |
| Firmware version | FIR-v1426 |
| Change history | |

Description

| Value in object 605A _h | Description |
|-----------------------------------|--|
| 0 | Immediate stop with subsequent state change to <i>Switch on disabled</i> |
| 1 | Braking with <i>slow down ramp</i> (deceleration ramp depending on operating mode) and subsequent state change to <i>Switch on disabled</i> |
| 2 | Braking with <i>quick stop ramp</i> (6085 _h) and subsequent state change to <i>Switch on disabled</i> |
| 5 | Braking with <i>slow down ramp</i> (deceleration ramp depending on operating mode) and subsequent state change to <i>Quick stop active</i> ; control does not switch off and the motor remains energized. You can switch back to the <i>Operation enabled</i> state. |
| 6 | Braking with <i>quick stop ramp</i> (6085 _h) and subsequent state change to <i>Quick Stop Active</i> ; control does not switch off and the motor remains energized. You can switch back to the <i>Operation enabled</i> state. |

In the mode Homing, the deceleration ramp set in 609A_h (Homing Acceleration) is used, instead of 6085_h.

605Bh Shutdown Option Code

Function

This object contains the action that is to be executed on a transition of the CiA 402 Power State Machine from the *Operation enabled* state to the *Ready to switch on* state.

Object description

| | |
|------------------|----------------------------|
| Index | 605B _h |
| Object name | Shutdown Option Code |
| Object Code | VARIABLE |
| Data type | INTEGER16 |
| Savable | yes, category: application |
| Access | read / write |
| PDO mapping | no |
| Allowed values | |
| Preset value | 0000 _h |
| Firmware version | FIR-v1426 |
| Change history | |

Description

| Value in object 605B _h | Description |
|-----------------------------------|--|
| -32768 ... -1 | Reserved |
| 0 | Blocking of the drive function – motor can turn freely |
| 1 | Braking with <i>slow down ramp</i> (braking deceleration depending on operating mode) and subsequent state change to <i>Ready to switch on</i> |
| 2 ... 32767 | Reserved |

605Ch Disable Operation Option Code

Function

This object contains the action that is to be executed on a transition of the CiA 402 Power State Machine from the *Operation enabled* state to the *Switched on* state.

Object description

| | |
|------------------|---|
| Index | 605C _h |
| Object name | Disable Operation Option Code |
| Object Code | VARIABLE |
| Data type | INTEGER16 |
| Savable | yes, category: application |
| Access | read / write |
| PDO mapping | no |
| Allowed values | |
| Preset value | 0001 _h |
| Firmware version | FIR-v1426 |
| Change history | Firmware version FIR-v2412-B1057638: entry "Object Name" changed from "Disable Option Code" to "Disable Operation Option Code". |

Description

| Value in object 605C _h | Description |
|-----------------------------------|---|
| -32768 ... -1 | Reserved |
| 0 | Switch off driver without deceleration ramp; drive function blocked |
| 1 | Braking with <i>slow down ramp</i> (braking deceleration depending on operating mode) and subsequent state change to <i>Switched on</i> |
| 2 ... 32767 | Reserved |

605Dh Halt Option Code

Function

The object contains the action that is to be executed if bit 8 (Halt) is set in controlword 6040_h.

Object description

| | |
|------------------|----------------------------|
| Index | 605D _h |
| Object name | Halt Option Code |
| Object Code | VARIABLE |
| Data type | INTEGER16 |
| Savable | yes, category: application |
| Access | read / write |
| PDO mapping | no |
| Allowed values | |
| Preset value | 0001 _h |
| Firmware version | FIR-v1426 |
| Change history | |

Description

| Value in object 605D _h | Description |
|-----------------------------------|---|
| -32768 ... 0 | Reserved |
| 1 | Braking with <i>slow down ramp</i> (braking deceleration depending on operating mode) |
| 2 | Braking with <i>quick stop ramp</i> (6085 _h) |
| 3 ... 32767 | Reserved |

605Eh Fault Reaction Option Code

Function

The object contains the action specifying how the motor is to be brought to a standstill in case of an error.

Object description

| | |
|------------------|--|
| Index | 605E _h |
| Object name | Fault Reaction Option Code |
| Object Code | VARIABLE |
| Data type | INTEGER16 |
| Savable | yes, category: application |
| Access | read / write |
| PDO mapping | no |
| Allowed values | |
| Preset value | 0002 _h |
| Firmware version | FIR-v1426 |
| Change history | Firmware version FIR-v2412-B1057638: entry "Object Name" changed from "Fault Option Code" to "Fault Reaction Option Code". |

Description

| Value in object 605E _h | Description |
|-----------------------------------|---|
| -32768 ... -1 | Reserved |
| 0 | Blocking of the drive function – motor can turn freely |
| 1 | Braking with <i>slow down ramp</i> (braking deceleration depending on operating mode) |
| 2 | Braking with <i>quick stop ramp</i> (6085 _h) |
| 3 ... 32767 | Reserved |

6060h Modes Of Operation

Function

The desired operating mode is entered in this object.

Object description

| | |
|------------------|--|
| Index | 6060 _h |
| Object name | Modes Of Operation |
| Object Code | VARIABLE |
| Data type | INTEGER8 |
| Savable | yes, category: application |
| Access | read / write |
| PDO mapping | RX-PDO |
| Allowed values | |
| Preset value | 00 _h |
| Firmware version | FIR-v1426 |
| Change history | Firmware version FIR-v1626: "Savable" entry changed from "no" to "yes, category: application". |

Description

| Mode | Description |
|------|---------------------------------|
| 0 | No mode change/no mode assigned |
| 1 | Profile Position Mode |
| 2 | Velocity Mode |
| 3 | Profile Velocity Mode |
| 4 | Profile Torque Mode |
| 5 | Reserved |
| 6 | Homing Mode |

6061h Modes Of Operation Display

Function

Indicates the current operating mode. See also [6060h Modes Of Operation](#).

Object description

| | |
|------------------|----------------------------|
| Index | 6061 _h |
| Object name | Modes Of Operation Display |
| Object Code | VARIABLE |
| Data type | INTEGER8 |
| Savable | no |
| Access | read only |
| PDO mapping | TX-PDO |
| Allowed values | |
| Preset value | 00 _h |
| Firmware version | FIR-v1426 |
| Change history | |

6062h Position Demand Value

Function

Indicates the current demand position in user-defined units.

Object description

| | |
|------------------|-----------------------|
| Index | 6062 _h |
| Object name | Position Demand Value |
| Object Code | VARIABLE |
| Data type | INTEGER32 |
| Savable | no |
| Access | read only |
| PDO mapping | TX-PDO |
| Allowed values | |
| Preset value | 00000000 _h |
| Firmware version | FIR-v1426 |
| Change history | |

6063h Position Actual Internal Value

Function

Contains the current actual position in encoder increments. Unlike objects 6062_h and 6064_h, this value is not set to "0" following a Homing operation. The source is determined in 3203h Feedback Selection.



NOTICE

If the encoder resolution in object 608F_h = zero, the numerical values of this object are invalid.

Object description

| | |
|-------|-------------------|
| Index | 6063 _h |
|-------|-------------------|

| | |
|------------------|--------------------------------|
| Object name | Position Actual Internal Value |
| Object Code | VARIABLE |
| Data type | INTEGER32 |
| Savable | no |
| Access | read only |
| PDO mapping | TX-PDO |
| Allowed values | |
| Preset value | 00000000 _h |
| Firmware version | FIR-v1426 |
| Change history | |

6064h Position Actual Value

Function

Contains the current actual position in user-defined units. The source is determined in 3203h Feedback Selection.

Object description

| | |
|------------------|-----------------------|
| Index | 6064 _h |
| Object name | Position Actual Value |
| Object Code | VARIABLE |
| Data type | INTEGER32 |
| Savable | no |
| Access | read only |
| PDO mapping | TX-PDO |
| Allowed values | |
| Preset value | 00000000 _h |
| Firmware version | FIR-v1426 |
| Change history | |

6065h Following Error Window

Function

Defines the maximum allowed following error in user-defined units symmetrically to the demand position.

Object description

| | |
|----------------|----------------------------|
| Index | 6065 _h |
| Object name | Following Error Window |
| Object Code | VARIABLE |
| Data type | UNSIGNED32 |
| Savable | yes, category: application |
| Access | read / write |
| PDO mapping | RX-PDO |
| Allowed values | |

| | |
|------------------|--|
| Preset value | 00000100 _h |
| Firmware version | FIR-v1426 |
| Change history | Firmware version FIR-v1504: "Savable" entry changed from "no" to "yes, category: application". |

Description

If the actual position deviates so much from the demand position that the value of this object is exceeded, bit 13 in object [6041_h](#) is set. The deviation must last longer than the time in object [6066_h](#).

If the value of the "Following Error Window" is set to "FFFFFFFF"_h, following error monitoring is switched off.

A reaction to the following error can be set in object [3700_h](#). If a reaction is defined, an error is also entered in object [1003_h](#).

6066h Following Error Time Out

Function

Time in milliseconds until a larger following error results in an error message.

Object description

| | |
|------------------|--|
| Index | 6066 _h |
| Object name | Following Error Time Out |
| Object Code | VARIABLE |
| Data type | UNSIGNED16 |
| Savable | yes, category: application |
| Access | read / write |
| PDO mapping | RX-PDO |
| Allowed values | |
| Preset value | 0064 _h |
| Firmware version | FIR-v1426 |
| Change history | Firmware version FIR-v1504: "Savable" entry changed from "no" to "yes, category: application". |

Description

If the actual position deviates so much from the demand position that the value of object [6065_h](#) is exceeded, bit 13 in object [6041_h](#) is set. The deviation must persist for longer than the time defined in this object.

A reaction to the following error can be set in object [3700_h](#). If a reaction is defined, an error is also entered in object [1003_h](#).

6067h Position Window

Function

Specifies a range symmetrical to the target position within which that target is considered having been met in modes [Profile Position](#) and [Interpolated Position Mode](#).

Object description

| | |
|------------------|--|
| Index | 6067 _h |
| Object name | Position Window |
| Object Code | VARIABLE |
| Data type | UNSIGNED32 |
| Savable | yes, category: application |
| Access | read / write |
| PDO mapping | RX-PDO |
| Allowed values | |
| Preset value | 0000000A _h |
| Firmware version | FIR-v1426 |
| Change history | Firmware version FIR-v1504: "Savable" entry changed from "no" to "yes, category: application". |

Description

If the current position deviates from the target position by less than the value of this object, bit 10 in object [6041_h](#) is set. The condition must be satisfied for longer than the time defined in object [6068_h](#).

If the value is set to "FFFFFFF"_h, monitoring is switched off.

6068h Position Window Time

Function

The current position must be within the "Position Window" ([6067_h](#)) for this time in milliseconds for the target position to be considered having been met in the [Profile Position](#) and [Interpolated Position Mode](#) modes.

Object description

| | |
|------------------|--|
| Index | 6068 _h |
| Object name | Position Window Time |
| Object Code | VARIABLE |
| Data type | UNSIGNED16 |
| Savable | yes, category: application |
| Access | read / write |
| PDO mapping | RX-PDO |
| Allowed values | |
| Preset value | 0064 _h |
| Firmware version | FIR-v1426 |
| Change history | Firmware version FIR-v1504: "Savable" entry changed from "no" to "yes, category: application". |

Description

If the current position deviates from the target position by less than the value of object [6067_h](#), bit 10 in object [6041_h](#) is set. The condition must be satisfied for longer than the time defined in object [6068_h](#).

606Bh Velocity Demand Value

Function

Speed specification in user-defined units for the velocity controller.

Object description

| | |
|------------------|-----------------------|
| Index | 606B _h |
| Object name | Velocity Demand Value |
| Object Code | VARIABLE |
| Data type | INTEGER32 |
| Savable | no |
| Access | read only |
| PDO mapping | TX-PDO |
| Allowed values | |
| Preset value | 00000000 _h |
| Firmware version | FIR-v1426 |
| Change history | |

Description

This object contains the output of the ramp generator, which simultaneously serves as the preset value for the velocity controller.

606Ch Velocity Actual Value

Function

Current actual speed in user-defined units.

Object description

| | |
|------------------|-----------------------|
| Index | 606C _h |
| Object name | Velocity Actual Value |
| Object Code | VARIABLE |
| Data type | INTEGER32 |
| Savable | no |
| Access | read only |
| PDO mapping | TX-PDO |
| Allowed values | |
| Preset value | 00000000 _h |
| Firmware version | FIR-v1426 |
| Change history | |

606Dh Velocity Window

Function

Specifies a symmetrical range relative to the target speed within which the target is considered having been met in the Profile Velocity mode.

Object description

| | |
|------------------|--|
| Index | 606D _h |
| Object name | Velocity Window |
| Object Code | VARIABLE |
| Data type | UNSIGNED16 |
| Savable | yes, category: application |
| Access | read / write |
| PDO mapping | RX-PDO |
| Allowed values | |
| Preset value | 001E _h |
| Firmware version | FIR-v1426 |
| Change history | Firmware version FIR-v1614: "Savable" entry changed from "no" to "yes, category: application". |

Description

If the current speed deviates from the set speed by less than the value of this object, bit 10 in object 6041_h is set. The condition must be satisfied for longer than the time defined in object 606E_h (see also [statusword in Profile Velocity Mode](#)).

606Eh Velocity Window Time

Function

The current speed must be within the "Velocity Window" (606D_h) for this time (in milliseconds) for the target to be considered having been met.

Object description

| | |
|------------------|--|
| Index | 606E _h |
| Object name | Velocity Window Time |
| Object Code | VARIABLE |
| Data type | UNSIGNED16 |
| Savable | yes, category: application |
| Access | read / write |
| PDO mapping | RX-PDO |
| Allowed values | |
| Preset value | 0000 _h |
| Firmware version | FIR-v1426 |
| Change history | Firmware version FIR-v1614: "Savable" entry changed from "no" to "yes, category: application". |

Description

Description

If the current speed deviates from the set speed by less than the value of object 606D_h, bit 10 in object 6041_h is set. The condition must be satisfied for longer than the time defined in object 606E (see also [statusword in Profile Velocity Mode](#)).

606Fh Velocity Threshold

Function

Speed in [user-defined units](#) above which the actual speed in [Profile Velocity](#) mode is considered to be nonzero.

Object description

| | |
|------------------|----------------------------|
| Index | 606F _h |
| Object name | Velocity Threshold |
| Object Code | VARIABLE |
| Data type | UNSIGNED16 |
| Savable | yes, category: application |
| Access | read / write |
| PDO mapping | RX-PDO |
| Allowed values | |
| Preset value | 0000 _h |
| Firmware version | FIR-v2013-B726332 |
| Change history | |

Description

If the actual speed is greater than the value in 606E_h(Velocity Threshold) for a time of 6070_h(Velocity Threshold Time), bit 12 in 6041_h(Statusword) has the value "0". The bit otherwise remains set to "1".

6070h Velocity Threshold Time

Function

Time in milliseconds above which an actual speed greater than the value in 606E_h in [Profile Velocity](#) mode is considered to be nonzero.

Object description

| | |
|----------------|----------------------------|
| Index | 6070 _h |
| Object name | Velocity Threshold Time |
| Object Code | VARIABLE |
| Data type | UNSIGNED16 |
| Savable | yes, category: application |
| Access | read / write |
| PDO mapping | RX-PDO |
| Allowed values | |
| Preset value | 0000 _h |

| | |
|------------------|-------------------|
| Firmware version | FIR-v2013-B726332 |
| Change history | |

Description

If the actual speed is greater than the value in 606E_h(Velocity Threshold) for a time of 6070_h(Velocity Threshold Time), bit 12 in 6041_h(Statusword) has the value "0". The bit otherwise remains set to "1".

6071h Target Torque

Function

This object contains the target torque for the Profile Torque and Cyclic Synchronous Torque modes in tenths of a percent of the rated torque.

Object description

| | |
|------------------|--|
| Index | 6071 _h |
| Object name | Target Torque |
| Object Code | VARIABLE |
| Data type | INTEGER16 |
| Savable | yes, category: application |
| Access | read / write |
| PDO mapping | RX-PDO |
| Allowed values | |
| Preset value | 000A _h |
| Firmware version | FIR-v1426 |
| Change history | Firmware version FIR-v1626: "Savable" entry changed from "no" to "yes, category: application". |

Description

This object is calculated as thousandths of the torque, e.g., the value "500" means "50%" of the rated torque; "1100" is equivalent to 110%. The rated torque corresponds to the rated current in object 203B_h:01.

The minimum of 6073_h and 6072_h is used as limit for the torque in 6071_h.

The target torque may not exceed the peak torque (proportional to the maximum motor current in 2031_h).

6072h Max Torque

Function

The object describes the maximum torque for the Profile Torque and Cyclic Synchronous Torque modes in tenths of a percent of the rated torque.

Object description

| | |
|-------------|-------------------|
| Index | 6072 _h |
| Object name | Max Torque |
| Object Code | VARIABLE |
| Data type | UNSIGNED16 |

| | |
|------------------|----------------------------|
| Savable | yes, category: application |
| Access | read / write |
| PDO mapping | RX-PDO |
| Allowed values | |
| Preset value | 0064 _h |
| Firmware version | FIR-v1426 |
| Change history | |

Description

This object is calculated as thousandths of the torque, e.g., the value "500" means "50%" of the rated torque; "1100" is equivalent to 110%. The rated torque corresponds to the rated current in object 203B_h:01.

The minimum of 6073_h and 6072_h is used as limit for the torque in 6071_h.

The target torque may not exceed the peak torque (proportional to the maximum motor current in 2031_h).

6073h Max Current

Function

Contains the maximum current in tenths of a percent of the set rated current. Is limited by the maximum motor current (2031_h). See also I2t Motor overload protection.

NOTICE



For stepper motors, only the rated current is specified, not a maximum current. Therefore, the value of 6073_h should generally not exceed the value 1000 (100%).

Object description

| | |
|------------------|----------------------|
| Index | 6073 _h |
| Object name | Max Current |
| Object Code | VARIABLE |
| Data type | UNSIGNED16 |
| Savable | yes, category: drive |
| Access | read / write |
| PDO mapping | RX-PDO |
| Allowed values | |
| Preset value | 03E8 _h |
| Firmware version | FIR-v1825-B577172 |
| Change history | |

Description

The maximum current is calculated in tenths of a percent of the rated current as follows:

$$(6073_{h} * 203B_{h}:01) / 1000$$

The maximum current determines:

- the maximum current for the I2t Motor overload protection
- the rated current in *open-loop* mode.

6074h Torque Demand

Function

Current torque set value requested by the ramp generator in tenths of a percent of the rated torque for the internal controller.

Object description

| | |
|------------------|-------------------|
| Index | 6074 _h |
| Object name | Torque Demand |
| Object Code | VARIABLE |
| Data type | INTEGER16 |
| Savable | no |
| Access | read only |
| PDO mapping | TX-PDO |
| Allowed values | |
| Preset value | 0000 _h |
| Firmware version | FIR-v1426 |
| Change history | |

Description

This object is calculated as thousandths of the torque, e.g., the value "500" means "50%" of the rated torque; "1100" is equivalent to 110%. The rated torque corresponds to the rated current in object 203B_h:01.

The minimum of 6073_h and 6072_h is used as limit for the torque in 6071_h.

The target torque may not exceed the peak torque (proportional to the maximum motor current in 2031_h).

6075h Motor Rated Current

Function

Contains the rated current entered in 203B_h:01_h in mA.

6077h Torque Actual Value

Function

This object indicates the current torque value in tenths of a percent of the rated torque for the internal controller.

Object description

| | |
|----------------|---------------------|
| Index | 6077 _h |
| Object name | Torque Actual Value |
| Object Code | VARIABLE |
| Data type | INTEGER16 |
| Savable | no |
| Access | read only |
| PDO mapping | TX-PDO |
| Allowed values | |

| | |
|------------------|-------------------|
| Preset value | 0000 _h |
| Firmware version | FIR-v1540 |
| Change history | |

Description

This object is calculated as thousandths of the torque, e.g., the value "500" means "50%" of the rated torque; "1100" is equivalent to 110%. The rated torque corresponds to the rated current in object 203B_h:01.

The minimum of 6073_h and 6072_h is used as limit for the torque in 6071_h.

The target torque may not exceed the peak torque (proportional to the maximum motor current in 2031_h).

607Ah Target Position

Function

This object specifies the target position in user-defined units for the Profile Position and Cyclic Synchronous Position modes.

Object description

| | |
|------------------|--|
| Index | 607A _h |
| Object name | Target Position |
| Object Code | VARIABLE |
| Data type | INTEGER32 |
| Savable | yes, category: application |
| Access | read / write |
| PDO mapping | RX-PDO |
| Allowed values | |
| Preset value | 00000E10 _h |
| Firmware version | FIR-v1426 |
| Change history | Firmware version FIR-v1626: "Savable" entry changed from "no" to "yes, category: application". |

607Bh Position Range Limit

Function

Contains the minimum and maximum position in user-defined units.

Object description

| | |
|------------------|----------------------------|
| Index | 607B _h |
| Object name | Position Range Limit |
| Object Code | ARRAY |
| Data type | INTEGER32 |
| Savable | yes, category: application |
| Firmware version | FIR-v1426 |
| Change history | |

Value description

| | |
|----------------|-------------------|
| Subindex | 00 _h |
| Name | Number Of Entries |
| Data type | UNSIGNED8 |
| Access | read only |
| PDO mapping | no |
| Allowed values | |
| Preset value | 02 _h |

| | |
|----------------|--------------------------|
| Subindex | 01 _h |
| Name | Min Position Range Limit |
| Data type | INTEGER32 |
| Access | read / write |
| PDO mapping | RX-PDO |
| Allowed values | |
| Preset value | 00000000 _h |

| | |
|----------------|--------------------------|
| Subindex | 02 _h |
| Name | Max Position Range Limit |
| Data type | INTEGER32 |
| Access | read / write |
| PDO mapping | RX-PDO |
| Allowed values | |
| Preset value | 00000000 _h |

Description

If this range is exceeded or not reached, an overflow occurs. To prevent this overflow, limit values for the target position can be set in object [607D_h](#) ("Software Position Limit").

607Ch Home Offset

Function

Specifies the difference between the zero position of the controller and the reference point of the machine in user-defined units.

Object description

| | |
|----------------|----------------------------|
| Index | 607C _h |
| Object name | Home Offset |
| Object Code | VARIABLE |
| Data type | INTEGER32 |
| Savable | yes, category: application |
| Access | read / write |
| PDO mapping | RX-PDO |
| Allowed values | |

| | |
|------------------|-----------------------|
| Preset value | 00000000 _h |
| Firmware version | FIR-v1426 |
| Change history | |

607Dh Software Position Limit

Function

Defines the limit positions relative to the reference point of the application in user-defined units.

Object description

| | |
|------------------|----------------------------|
| Index | 607D _h |
| Object name | Software Position Limit |
| Object Code | ARRAY |
| Data type | INTEGER32 |
| Savable | yes, category: application |
| Firmware version | FIR-v1426 |
| Change history | |

Value description

| | |
|----------------|-------------------|
| Subindex | 00 _h |
| Name | Number Of Entries |
| Data type | UNSIGNED8 |
| Access | read only |
| PDO mapping | no |
| Allowed values | |
| Preset value | 02 _h |

| | |
|----------------|-----------------------|
| Subindex | 01 _h |
| Name | Min Position Limit |
| Data type | INTEGER32 |
| Access | read / write |
| PDO mapping | RX-PDO |
| Allowed values | |
| Preset value | 00000000 _h |

| | |
|----------------|-----------------------|
| Subindex | 02 _h |
| Name | Max Position Limit |
| Data type | INTEGER32 |
| Access | read / write |
| PDO mapping | RX-PDO |
| Allowed values | |
| Preset value | 00000000 _h |

Description

The absolute target position must lie within the limits set here. The Home Offset ($607C_h$) is not taken into account.

607Eh Polarity

Function

With this object, the direction of rotation can be reversed.

Object description

| | |
|------------------|--|
| Index | 607E _h |
| Object name | Polarity |
| Object Code | VARIABLE |
| Data type | UNSIGNED8 |
| Savable | yes, category: application |
| Access | read / write |
| PDO mapping | RX-PDO |
| Allowed values | |
| Preset value | 00 _h |
| Firmware version | FIR-v1426 |
| Change history | Firmware version FIR-v1738-B501312: "PDO mapping" table entry for subindex 00 changed from "no" to "RX-PDO". |

Description

The following generally applies for direction reversal: If a bit is set to the value "1", reversal is activated. If the value is "0", the direction of rotation is as described in the respective mode.

| | | | | | | | |
|-----|-----|---|---|---|---|---|---|
| 7 | 6 | 5 | 4 | 3 | 2 | 1 | 0 |
| POS | VEL | | | | | | |

VEL (Velocity)

Direction of rotation reversal in the following modes:

- [Profile Velocity Mode](#)
- [Cyclic Synchronous Velocity Mode](#)

POS (Position)

Direction of rotation reversal in the following modes:

- [Profile Position Mode](#)
- [Cyclic Synchronous Position Mode](#)



TIP

You can force an inversion of the rotary field that affects all operating modes. See object $3212_h:02_h$.

607Fh Max Profile Velocity

Function

Specifies the maximum speed in user-defined units for which the Mod i Profile Position and Profile Velocity.

Object description

| | |
|------------------|--|
| Index | 607F _h |
| Object name | Max Profile Velocity |
| Object Code | VARIABLE |
| Data type | UNSIGNED32 |
| Savable | yes, category: application |
| Access | read / write |
| PDO mapping | RX-PDO |
| Allowed values | |
| Preset value | 00007530 _h |
| Firmware version | FIR-v1540 |
| Change history | <p>Firmware version FIR-v1738-B501312: "Object Name" entry changed from "Max profile velocity" to "Max Profile Velocity".</p> <p>Firmware version FIR-v1738-B501312: "Data type" entry changed from "INTEGER16" to "UNSIGNED32".</p> <p>Firmware version FIR-v1738-B501312: "Savable" entry changed from "no" to "yes, category: application".</p> <p>Firmware version FIR-v1738-B501312: "Access" table entry for subindex 00 changed from "read only" to "read/write".</p> <p>Firmware version FIR-v1738-B501312: "PDO mapping" table entry for subindex 00 changed from "TX-PDO" to "RX-PDO".</p> |

6080h Max Motor Speed

Function

Contains the maximum permissible speed of the motor in user-defined units.

Object description

| | |
|------------------|-----------------------|
| Index | 6080 _h |
| Object name | Max Motor Speed |
| Object Code | VARIABLE |
| Data type | UNSIGNED32 |
| Savable | yes, category: drive |
| Access | read / write |
| PDO mapping | RX-PDO |
| Allowed values | |
| Preset value | 00001194 _h |
| Firmware version | FIR-v1426 |

Change history

Firmware version FIR-v1614: "Savable" entry changed from "yes, category: application" to "yes, category: tuning".

Firmware version FIR-v1738-B501312: "Object Name" entry changed from "Maximum Speed" to "Max Motor Speed".

Firmware version FIR-v1738-B501312: "PDO mapping" table entry for subindex 00 changed from "no" to "RX-PDO".

Firmware version FIR-v1748-B538662: "Savable" entry changed from "yes, category: tuning" to "yes, category: movement".

Firmware version FIR-v1825-B577172: "Savable" entry changed from "yes, category: movement" to "yes, category: tuning".

Firmware version FIR-v1825-B577172: "Savable" entry changed from "yes, category: tuning" to "yes, category: movement".

6081h Profile Velocity

Function

Specifies the maximum travel speed in user-defined units.

Object description

| | |
|------------------|----------------------------|
| Index | 6081 _h |
| Object name | Profile Velocity |
| Object Code | VARIABLE |
| Data type | UNSIGNED32 |
| Savable | yes, category: application |
| Access | read / write |
| PDO mapping | RX-PDO |
| Allowed values | |
| Preset value | 000001F4 _h |
| Firmware version | FIR-v1426 |
| Change history | |

6082h End Velocity

Function

Specifies the speed at the end of the traveled ramp in user-defined units.

Object description

| | |
|-------------|----------------------------|
| Index | 6082 _h |
| Object name | End Velocity |
| Object Code | VARIABLE |
| Data type | UNSIGNED32 |
| Savable | yes, category: application |
| Access | read / write |
| PDO mapping | RX-PDO |

| | |
|------------------|-----------------------|
| Allowed values | |
| Preset value | 00000000 _h |
| Firmware version | FIR-v1426 |
| Change history | |

6083h Profile Acceleration

Function

Specifies the maximum acceleration in user-defined units.

Object description

| | |
|------------------|----------------------------|
| Index | 6083 _h |
| Object name | Profile Acceleration |
| Object Code | VARIABLE |
| Data type | UNSIGNED32 |
| Savable | yes, category: application |
| Access | read / write |
| PDO mapping | RX-PDO |
| Allowed values | |
| Preset value | 000001F4 _h |
| Firmware version | FIR-v1426 |
| Change history | |

6084h Profile Deceleration

Function

Specifies the maximum deceleration (deceleration ramp) in user-defined units. Is limited by 60C6_h.

Object description

| | |
|------------------|----------------------------|
| Index | 6084 _h |
| Object name | Profile Deceleration |
| Object Code | VARIABLE |
| Data type | UNSIGNED32 |
| Savable | yes, category: application |
| Access | read / write |
| PDO mapping | RX-PDO |
| Allowed values | |
| Preset value | 000001F4 _h |
| Firmware version | FIR-v1426 |
| Change history | |

6085h Quick Stop Deceleration

Function

Specifies the maximum Quick Stop Deceleration in user-defined units. Depending on the operating mode, is limited by 60C6_h (Max Deceleration) and, if applicable, 60A4_h (Profile Jerk).

Object description

| | |
|------------------|----------------------------|
| Index | 6085 _h |
| Object name | Quick Stop Deceleration |
| Object Code | VARIABLE |
| Data type | UNSIGNED32 |
| Savable | yes, category: application |
| Access | read / write |
| PDO mapping | RX-PDO |
| Allowed values | |
| Preset value | 00001388 _h |
| Firmware version | FIR-v1426 |
| Change history | |

6086h Motion Profile Type

Function

Specifies the ramp type for the Profile Position and Profile Velocity modes.

Object description

| | |
|------------------|----------------------------|
| Index | 6086 _h |
| Object name | Motion Profile Type |
| Object Code | VARIABLE |
| Data type | INTEGER16 |
| Savable | yes, category: application |
| Access | read / write |
| PDO mapping | RX-PDO |
| Allowed values | |
| Preset value | 0000 _h |
| Firmware version | FIR-v1426 |
| Change history | |

Description

Value = "0": = Trapezoidal ramp

Value = "3": Ramp with limited jerk

6087h Torque Slope

Function

This object contains the slope of the torque in Torque mode.

Object description

| | |
|------------------|----------------------------|
| Index | 6087 _h |
| Object name | Torque Slope |
| Object Code | VARIABLE |
| Data type | UNSIGNED32 |
| Savable | yes, category: application |
| Access | read / write |
| PDO mapping | RX-PDO |
| Allowed values | |
| Preset value | 000003E8 _h |
| Firmware version | FIR-v1426 |
| Change history | |

Description

This object is calculated as thousandths of the torque, e.g., the value "500" means "50%" of the rated torque; "1100" is equivalent to 110%. The rated torque corresponds to the rated current in object 203B_h:01.

The minimum of 6073_h and 6072_h is used as limit for the torque in 6071_h.

The target torque may not exceed the peak torque (proportional to the maximum motor current in 2031_h).

608Fh Position Encoder Resolution

Function

Contains the physical resolution (see objects 60E6_h/60EB_h) of the encoder/sensor that is used for position control (see 3203h Feedback Selection).

Object description

| | |
|------------------|--|
| Index | 608F _h |
| Object name | Position Encoder Resolution |
| Object Code | ARRAY |
| Data type | INTEGER32 |
| Savable | yes, category: tuning |
| Firmware version | FIR-v1426 |
| Change history | <p>Firmware version FIR-v1738-B501312: "Savable" entry changed from "yes, category: application" to "yes, category: tuning".</p> <p>Firmware version FIR-v1738-B501312: "PDO mapping" table entry for subindex 01 changed from "no" to "RX-PDO".</p> <p>Firmware version FIR-v1738-B501312: "PDO mapping" table entry for subindex 02 changed from "no" to "RX-PDO".</p> |

Firmware version FIR-v1748-B538662: "Data type" entry changed from "UNSIGNED32" to "INTEGER32".

Value description

| | |
|----------------|-------------------|
| Subindex | 00 _h |
| Name | Number Of Entries |
| Data type | UNSIGNED8 |
| Access | read only |
| PDO mapping | no |
| Allowed values | |
| Preset value | 02 _h |

| | |
|----------------|-----------------------|
| Subindex | 01 _h |
| Name | Encoder Increments |
| Data type | INTEGER32 |
| Access | read / write |
| PDO mapping | RX-PDO |
| Allowed values | |
| Preset value | 00000000 _h |

| | |
|----------------|-----------------------|
| Subindex | 02 _h |
| Name | Motor Revolutions |
| Data type | INTEGER32 |
| Access | read / write |
| PDO mapping | RX-PDO |
| Allowed values | |
| Preset value | 00000001 _h |

Description

Position Encoder Resolution = Encoder Increments (608F_h:01_h) / Motor Revolutions (608F_h:02_h)

6090h Velocity Encoder Resolution

Function

Contains the physical resolution (see objects 60E6_h/ 60EB_h) of the encoder/sensor that is used for speed control (see 3203h Feedback Selection).

Object description

| | |
|-------------|-----------------------------|
| Index | 6090 _h |
| Object name | Velocity Encoder Resolution |
| Object Code | ARRAY |
| Data type | INTEGER32 |
| Savable | yes, category: tuning |

| | |
|------------------|---|
| Access | read only |
| PDO mapping | no |
| Allowed values | |
| Preset value | |
| Firmware version | FIR-v1738-B501312 |
| Change history | <p>Firmware version FIR-v1748-B538662: "Data type" entry changed from "UNSIGNED32" to "INTEGER32".</p> <p>Firmware version FIR-v1748-B538662: "Data type" entry changed from "UNSIGNED32" to "INTEGER32".</p> <p>Firmware version FIR-v1748-B538662: "Data type" entry changed from "UNSIGNED32" to "INTEGER32".</p> <p>Firmware version FIR-v1825-B577172: "Data type" entry changed from "INTEGER32" to "UNSIGNED32".</p> <p>Firmware version FIR-v1825-B577172: "Data type" entry changed from "INTEGER32" to "UNSIGNED32".</p> <p>Firmware version FIR-v1825-B577172: "Data type" entry changed from "INTEGER32" to "UNSIGNED32".</p> <p>Firmware version FIR-v1825-B577172: "Data type" entry changed from "UNSIGNED32" to "INTEGER32".</p> <p>Firmware version FIR-v1825-B577172: "Data type" entry changed from "UNSIGNED32" to "INTEGER32".</p> |

Value description

| | |
|----------------|-------------------------------|
| Subindex | 00 _h |
| Name | Number Of Entries |
| Data type | UNSIGNED8 |
| Access | read only |
| PDO mapping | no |
| Allowed values | |
| Preset value | 02 _h |
| Subindex | 01 _h |
| Name | Encoder Increments Per Second |
| Data type | INTEGER32 |
| Access | read / write |
| PDO mapping | RX-PDO |
| Allowed values | |
| Preset value | 00000000 _h |
| Subindex | 02 _h |
| Name | Motor Revolutions Per Second |
| Data type | INTEGER32 |

| | |
|----------------|-----------------------|
| Access | read / write |
| PDO mapping | RX-PDO |
| Allowed values | |
| Preset value | 00000001 _h |

Description

Velocity Encoder Resolution = Encoder Increments per second (6090_h:01_h) / Motor Revolutions per second (6090_h:02_h)

6091h Gear Ratio

Function

Contains the gear ratio (number of motor revolutions per revolution of the output shaft) of the encoder/sensor that is used for position control (see [3203h Feedback Selection](#)).

Object description

| | |
|------------------|--|
| Index | 6091 _h |
| Object name | Gear Ratio |
| Object Code | ARRAY |
| Data type | UNSIGNED32 |
| Savable | yes, category: application |
| Firmware version | FIR-v1426 |
| Change history | Firmware version FIR-v1738-B501312: "PDO mapping" table entry for subindex 01 changed from "no" to "RX-PDO". Firmware version FIR-v1738-B501312: "PDO mapping" table entry for subindex 02 changed from "no" to "RX-PDO". |

Value description

| | |
|----------------|-------------------|
| Subindex | 00 _h |
| Name | Number Of Entries |
| Data type | UNSIGNED8 |
| Access | read only |
| PDO mapping | no |
| Allowed values | |
| Preset value | 02 _h |

| | |
|----------------|-----------------------|
| Subindex | 01 _h |
| Name | Motor Revolutions |
| Data type | UNSIGNED32 |
| Access | read / write |
| PDO mapping | RX-PDO |
| Allowed values | |
| Preset value | 00000001 _h |

| | |
|----------------|-----------------------|
| Subindex | 02 _h |
| Name | Shaft Revolutions |
| Data type | UNSIGNED32 |
| Access | read / write |
| PDO mapping | RX-PDO |
| Allowed values | |
| Preset value | 00000001 _h |

Description

Gear Ratio = Motor Revolutions (6091_h:01_h) / Shaft Revolutions (6091_h:02_h)

6092h Feed Constant

Function

Contains the feed constant (feed in user-defined units per revolution of the output shaft) of the encoder/sensor that is used for position control (see [3203h Feedback Selection](#)).

Object description

| | |
|------------------|----------------------------|
| Index | 6092 _h |
| Object name | Feed Constant |
| Object Code | ARRAY |
| Data type | UNSIGNED32 |
| Savable | yes, category: application |
| Firmware version | FIR-v1426 |
| Change history | |

Value description

| | |
|----------------|-------------------|
| Subindex | 00 _h |
| Name | Number Of Entries |
| Data type | UNSIGNED8 |
| Access | read only |
| PDO mapping | no |
| Allowed values | |
| Preset value | 02 _h |

| | |
|----------------|-----------------------|
| Subindex | 01 _h |
| Name | Feed |
| Data type | UNSIGNED32 |
| Access | read / write |
| PDO mapping | RX-PDO |
| Allowed values | |
| Preset value | 00000001 _h |

| | |
|----------------|-----------------------|
| Subindex | 02 _h |
| Name | Shaft Revolutions |
| Data type | UNSIGNED32 |
| Access | read / write |
| PDO mapping | RX-PDO |
| Allowed values | |
| Preset value | 00000001 _h |

Description

Feed Constant = Feed (6092_h:01_h) / Shaft Revolutions (6092_h:02_h)

6096h Velocity Factor

Function

This object contains the factor that is used for converting from user-defined speed units. See chapter [User-defined units](#).

Object description

| | |
|------------------|----------------------------|
| Index | 6096 _h |
| Object name | Velocity Factor |
| Object Code | ARRAY |
| Data type | UNSIGNED32 |
| Savable | yes, category: application |
| Access | read only |
| PDO mapping | no |
| Allowed values | |
| Preset value | |
| Firmware version | FIR-v1738-B501312 |
| Change history | |

Value description

| | |
|----------------|-------------------|
| Subindex | 00 _h |
| Name | Number Of Entries |
| Data type | UNSIGNED8 |
| Access | read only |
| PDO mapping | no |
| Allowed values | |
| Preset value | 02 _h |

| | |
|-----------|-----------------|
| Subindex | 01 _h |
| Name | Numerator |
| Data type | UNSIGNED32 |
| Access | read / write |

| | |
|----------------|-----------------------|
| PDO mapping | RX-PDO |
| Allowed values | |
| Preset value | 00000001 _h |

| | |
|----------------|-----------------------|
| Subindex | 02 _h |
| Name | Divisor |
| Data type | UNSIGNED32 |
| Access | read / write |
| PDO mapping | RX-PDO |
| Allowed values | |
| Preset value | 00000001 _h |

Description

The subindices have the following functions:

- 01_h: Numerator of the factor
- 02_h: Denominator of the factor

6097h Acceleration Factor

Function

This object contains the factor that is used for converting from user-defined acceleration units. See chapter [User-defined units](#).

Object description

| | |
|------------------|----------------------------|
| Index | 6097 _h |
| Object name | Acceleration Factor |
| Object Code | ARRAY |
| Data type | UNSIGNED32 |
| Savable | yes, category: application |
| Access | read only |
| PDO mapping | no |
| Allowed values | |
| Preset value | |
| Firmware version | FIR-v1738-B501312 |
| Change history | |

Value description

| | |
|----------------|-------------------|
| Subindex | 00 _h |
| Name | Number Of Entries |
| Data type | UNSIGNED8 |
| Access | read only |
| PDO mapping | no |
| Allowed values | |

| | |
|----------------|-----------------------|
| Preset value | 02 _h |
| Subindex | 01 _h |
| Name | Numerator |
| Data type | UNSIGNED32 |
| Access | read / write |
| PDO mapping | RX-PDO |
| Allowed values | |
| Preset value | 00000001 _h |
| Subindex | 02 _h |
| Name | Divisor |
| Data type | UNSIGNED32 |
| Access | read / write |
| PDO mapping | RX-PDO |
| Allowed values | |
| Preset value | 00000001 _h |

Description

The subindices have the following functions:

- 01_h: Numerator of the factor
- 02_h: Denominator of the factor

6098h Homing Method

Function

This object defines the Homing method in Homing mode.

Object description

| | |
|------------------|----------------------------|
| Index | 6098 _h |
| Object name | Homing Method |
| Object Code | VARIABLE |
| Data type | INTEGER8 |
| Savable | yes, category: application |
| Access | read / write |
| PDO mapping | RX-PDO |
| Allowed values | |
| Preset value | 23 _h |
| Firmware version | FIR-v1426 |
| Change history | |

6099h Homing Speed

Function

Specifies the speeds for homing mode (6098_h) in user-defined units.

Object description

| | |
|------------------|----------------------------|
| Index | 6099 _h |
| Object name | Homing Speed |
| Object Code | ARRAY |
| Data type | UNSIGNED32 |
| Savable | yes, category: application |
| Firmware version | FIR-v1426 |
| Change history | |

Value description

| | |
|----------------|-------------------|
| Subindex | 00 _h |
| Name | Number Of Entries |
| Data type | UNSIGNED8 |
| Access | read only |
| PDO mapping | no |
| Allowed values | |
| Preset value | 02 _h |

| | |
|----------------|--------------------------------|
| Subindex | 01 _h |
| Name | Speed During Search For Switch |
| Data type | UNSIGNED32 |
| Access | read / write |
| PDO mapping | RX-PDO |
| Allowed values | |
| Preset value | 00000032 _h |

| | |
|----------------|------------------------------|
| Subindex | 02 _h |
| Name | Speed During Search For Zero |
| Data type | UNSIGNED32 |
| Access | read / write |
| PDO mapping | RX-PDO |
| Allowed values | |
| Preset value | 00000003 _h |

Description

The speed for the search for the switch is specified in subindex 1.

The (lower) speed for the search for the reference position is specified in subindex 2.

NOTICE



- The speed in subindex 2 is simultaneously the initial speed when starting the acceleration ramp. If this is set too high, the motor loses steps or fails to turn at all. If the setting is too high, the index marking will be overlooked, especially with high-resolution encoders. The minimum detectable width of the index pulse is 31.25 μ s.
- The speed in subindex 1 must be greater than the speed in subindex 2.

609Ah Homing Acceleration

Function

Specifies the acceleration ramp for homing mode in user-defined units.

Object description

| | |
|------------------|----------------------------|
| Index | 609A _h |
| Object name | Homing Acceleration |
| Object Code | VARIABLE |
| Data type | UNSIGNED32 |
| Savable | yes, category: application |
| Access | read / write |
| PDO mapping | RX-PDO |
| Allowed values | |
| Preset value | 000001F4 _h |
| Firmware version | FIR-v1426 |
| Change history | |

Description

The ramp is only used when starting up. When the switch is reached, the motor immediately switches to the lower speed; when the end position is reached, it immediately stops.

60A2h Jerk Factor

Function

This object contains the factor that is used for converting from user-defined jerk units. See chapter User-defined units.

Object description

| | |
|----------------|----------------------------|
| Index | 60A2 _h |
| Object name | Jerk Factor |
| Object Code | ARRAY |
| Data type | UNSIGNED32 |
| Savable | yes, category: application |
| Access | read only |
| PDO mapping | no |
| Allowed values | |

| | |
|------------------|-------------------|
| Preset value | |
| Firmware version | FIR-v1738-B501312 |
| Change history | |

Value description

| | |
|----------------|-------------------|
| Subindex | 00 _h |
| Name | Number Of Entries |
| Data type | UNSIGNED8 |
| Access | read only |
| PDO mapping | no |
| Allowed values | |
| Preset value | 02 _h |

| | |
|----------------|-----------------------|
| Subindex | 01 _h |
| Name | Numerator |
| Data type | UNSIGNED32 |
| Access | read / write |
| PDO mapping | RX-PDO |
| Allowed values | |
| Preset value | 00000001 _h |

| | |
|----------------|-----------------------|
| Subindex | 02 _h |
| Name | Divisor |
| Data type | UNSIGNED32 |
| Access | read / write |
| PDO mapping | RX-PDO |
| Allowed values | |
| Preset value | 00000001 _h |

Description

The subindices have the following functions:

- 01_h: Numerator of the factor
- 02_h: Denominator of the factor

60A4h Profile Jerk

Function

In the case of a ramp with limited jerk, the size of the jerk in user-defined units can be entered in this object. An entry with the value "0" means that the jerk is not limited.

Object description

| | |
|-------------|-------------------|
| Index | 60A4 _h |
| Object name | Profile Jerk |

| | |
|------------------|---|
| Object Code | ARRAY |
| Data type | UNSIGNED32 |
| Savable | yes, category: application |
| Firmware version | FIR-v1426 |
| Change history | <p>Firmware version FIR-v1614: "Name" entry changed from "End Acceleration Jerk" to "Begin Deceleration Jerk".</p> <p>Firmware version FIR-v1614: "Name" entry changed from "Begin Deceleration Jerk" to "End Acceleration Jerk".</p> |

Value description

| | |
|----------------|-------------------|
| Subindex | 00 _h |
| Name | Number Of Entries |
| Data type | UNSIGNED8 |
| Access | read only |
| PDO mapping | no |
| Allowed values | |
| Preset value | 04 _h |

| | |
|----------------|-------------------------|
| Subindex | 01 _h |
| Name | Begin Acceleration Jerk |
| Data type | UNSIGNED32 |
| Access | read / write |
| PDO mapping | no |
| Allowed values | |
| Preset value | 000003E8 _h |

| | |
|----------------|-------------------------|
| Subindex | 02 _h |
| Name | Begin Deceleration Jerk |
| Data type | UNSIGNED32 |
| Access | read / write |
| PDO mapping | no |
| Allowed values | |
| Preset value | 000003E8 _h |

| | |
|----------------|-----------------------|
| Subindex | 03 _h |
| Name | End Acceleration Jerk |
| Data type | UNSIGNED32 |
| Access | read / write |
| PDO mapping | no |
| Allowed values | |
| Preset value | 000003E8 _h |

| | |
|----------------|-----------------------|
| Subindex | 04 _h |
| Name | End Deceleration Jerk |
| Data type | UNSIGNED32 |
| Access | read / write |
| PDO mapping | no |
| Allowed values | |
| Preset value | 000003E8 _h |

Description

- Subindex 01_h (*Begin Acceleration Jerk*): Initial jerk during acceleration
- Subindex 02_h (*Begin Deceleration Jerk*): Initial jerk during braking
- Subindex 03_h (*End Acceleration Jerk*): Final jerk during acceleration
- Subindex 04_h (*End Deceleration Jerk*): Final jerk during braking

60A8h SI Unit Position

Function

This object contains the position unit. See chapter [User-defined units](#).

Object description

| | |
|------------------|----------------------------|
| Index | 60A8 _h |
| Object name | SI Unit Position |
| Object Code | VARIABLE |
| Data type | UNSIGNED32 |
| Savable | yes, category: application |
| Access | read / write |
| PDO mapping | no |
| Allowed values | |
| Preset value | FF410000 _h |
| Firmware version | FIR-v1738-B501312 |
| Change history | |

Description

Object 60A8_h contains:

- Bits 16 to 23: The position unit (see chapter [Units](#))
- Bits 24 to 31: The exponent of a power of ten (see chapter [Units](#))

| | | | | | | | | | | | | | | | |
|----------------|----|----|----|----|----|----|----|----------------|----|----|----|----|----|----|----|
| 31 | 30 | 29 | 28 | 27 | 26 | 25 | 24 | 23 | 22 | 21 | 20 | 19 | 18 | 17 | 16 |
| Factor | | | | | | | | Unit | | | | | | | |
| 15 | 14 | 13 | 12 | 11 | 10 | 9 | 8 | 7 | 6 | 5 | 4 | 3 | 2 | 1 | 0 |
| reserved (00h) | | | | | | | | reserved (00h) | | | | | | | |

60A9h SI Unit Velocity

Function

This object contains the speed unit. See chapter [User-defined units](#).

Object description

| | |
|------------------|----------------------------|
| Index | 60A9 _h |
| Object name | SI Unit Velocity |
| Object Code | VARIABLE |
| Data type | UNSIGNED32 |
| Savable | yes, category: application |
| Access | read / write |
| PDO mapping | no |
| Allowed values | |
| Preset value | 00B44700 _h |
| Firmware version | FIR-v1738-B501312 |
| Change history | |

Description

Object 60A9_h contains:

- Bits 8 to 15: The time unit (see chapter [Units](#))
- Bits 16 to 23: The position unit (see chapter [Units](#))
- Bits 24 to 31: The exponent of a power of ten (see chapter [Units](#))

| | | | | | | | | | | | | | | | |
|--------------------|----|----|----|----|----|----|----|----------------------|----|----|----|----|----|----|----|
| 31 | 30 | 29 | 28 | 27 | 26 | 25 | 24 | 23 | 22 | 21 | 20 | 19 | 18 | 17 | 16 |
| Factor | | | | | | | | Nominator (Position) | | | | | | | |
| 15 | 14 | 13 | 12 | 11 | 10 | 9 | 8 | 7 | 6 | 5 | 4 | 3 | 2 | 1 | 0 |
| Denominator (Time) | | | | | | | | reserved (00h) | | | | | | | |

60B0h Position Offset

Function

Offset for the position set value in [user-defined units](#). Is taken into account in mode [Cyclic Synchronous Position](#).

Object description

| | |
|----------------|----------------------------|
| Index | 60B0 _h |
| Object name | Position Offset |
| Object Code | VARIABLE |
| Data type | INTEGER32 |
| Savable | yes, category: application |
| Access | read / write |
| PDO mapping | RX-PDO |
| Allowed values | |
| Preset value | 00000000 _h |

| | |
|------------------|-------------------|
| Firmware version | FIR-v1738-B505321 |
| Change history | |

60B1h Velocity Offset

Function

Offset for the speed set value in user-defined units. Is taken into account in the Cyclic Synchronous Position, Cyclic Synchronous Velocity and Clock-direction mode modes.

Object description

| | |
|------------------|----------------------------|
| Index | 60B1 _h |
| Object name | Velocity Offset |
| Object Code | VARIABLE |
| Data type | INTEGER32 |
| Savable | yes, category: application |
| Access | read / write |
| PDO mapping | RX-PDO |
| Allowed values | |
| Preset value | 00000000 _h |
| Firmware version | FIR-v1738-B505321 |
| Change history | |

60B2h Torque Offset

Function

Offset for the torque set value in tenths of a percent. Is taken into account in the Cyclic Synchronous Position, Cyclic Synchronous Velocity, Cyclic Synchronous Torque and Clock-direction mode modes.

Object description

| | |
|------------------|----------------------------|
| Index | 60B2 _h |
| Object name | Torque Offset |
| Object Code | VARIABLE |
| Data type | INTEGER16 |
| Savable | yes, category: application |
| Access | read / write |
| PDO mapping | RX-PDO |
| Allowed values | |
| Preset value | 0000 _h |
| Firmware version | FIR-v1738-B505321 |
| Change history | |

60C1h Interpolation Data Record

Function

This object contains the demand position in user-defined units for the interpolation algorithm for the interpolated position operating mode.

Object description

| | |
|------------------|--|
| Index | 60C1 _h |
| Object name | Interpolation Data Record |
| Object Code | ARRAY |
| Data type | INTEGER32 |
| Savable | yes, category: application |
| Access | read only |
| PDO mapping | no |
| Allowed values | |
| Preset value | |
| Firmware version | FIR-v1512 |
| Change history | Firmware version FIR-v1626: "Savable" entry changed from "no" to "yes, category: application". |

Value description

| | |
|----------------|-------------------|
| Subindex | 00 _h |
| Name | Number Of Entries |
| Data type | UNSIGNED8 |
| Access | read only |
| PDO mapping | no |
| Allowed values | |
| Preset value | 01 _h |

| | |
|----------------|-----------------------|
| Subindex | 01 _h |
| Name | 1st Set-point |
| Data type | INTEGER32 |
| Access | read / write |
| PDO mapping | RX-PDO |
| Allowed values | |
| Preset value | 00000000 _h |

Description

The value is taken over at the next synchronization time.

60C2h Interpolation Time Period

Function

This object contains the interpolation time.

Object description

| | |
|------------------|----------------------------|
| Index | 60C2 _h |
| Object name | Interpolation Time Period |
| Object Code | RECORD |
| Data type | INTERPOLATION_TIME_PERIOD |
| Savable | yes, category: application |
| Access | read only |
| PDO mapping | no |
| Allowed values | |
| Preset value | |
| Firmware version | FIR-v1426 |
| Change history | |

Value description

| | |
|----------------|-------------------|
| Subindex | 00 _h |
| Name | Number Of Entries |
| Data type | UNSIGNED8 |
| Access | read only |
| PDO mapping | no |
| Allowed values | |
| Preset value | 02 _h |

| | |
|----------------|---------------------------------|
| Subindex | 01 _h |
| Name | Interpolation Time Period Value |
| Data type | UNSIGNED8 |
| Access | read / write |
| PDO mapping | no |
| Allowed values | |
| Preset value | 01 _h |

| | |
|----------------|--------------------------|
| Subindex | 02 _h |
| Name | Interpolation Time Index |
| Data type | INTEGER8 |
| Access | read / write |
| PDO mapping | no |
| Allowed values | |
| Preset value | FD _h |

Description

The subindices have the following functions:

- 01_h: Interpolation time.
- 02_h: Power of ten of the interpolation time: must have the value -3 (corresponds to the time basis in milliseconds).

The following applies here: cycle time = value of 60C2_h:01_h * 10^{value of 60C2:02} seconds.

60C4h Interpolation Data Configuration

Function

This object offers the maximum buffer size, specifies the configured buffer organization of the interpolated data and offers objects for defining the size of the record and for deleting the buffer.

It is also used to store the position of other data points.

Object description

| | |
|------------------|---|
| Index | 60C4 _h |
| Object name | Interpolation Data Configuration |
| Object Code | RECORD |
| Data type | INTERPOLATION_DATA_CONFIGURATION |
| Savable | yes, category: application |
| Access | read only |
| PDO mapping | no |
| Allowed values | |
| Preset value | |
| Firmware version | FIR-v1512 |
| Change history | <p>Firmware version FIR-v1540: "Access" table entry for subindex 05 changed from "read/write" to "write only".</p> <p>Firmware version FIR-v1540: "Access" table entry for subindex 06 changed from "read/write" to "write only".</p> <p>Firmware version FIR-v1626: "Savable" entry changed from "no" to "yes, category: application".</p> <p>Firmware version FIR-v1650-B472161: "Access" table entry for subindex 01 changed from "read/write" to "read only".</p> <p>Firmware version FIR-v2412-B1057638: entry "Name" changed from "Buffer Organization" to "Buffer Organisation".</p> |

Value description

| | |
|----------------|-------------------|
| Subindex | 00 _h |
| Name | Number Of Entries |
| Data type | UNSIGNED8 |
| Access | read only |
| PDO mapping | no |
| Allowed values | |
| Preset value | 06 _h |

| | |
|----------------|-----------------------|
| Subindex | 01 _h |
| Name | Maximum Buffer Size |
| Data type | UNSIGNED32 |
| Access | read only |
| PDO mapping | no |
| Allowed values | |
| Preset value | 00000000 _h |

| | |
|----------------|-----------------------|
| Subindex | 02 _h |
| Name | Actual Buffer Size |
| Data type | UNSIGNED32 |
| Access | read / write |
| PDO mapping | no |
| Allowed values | |
| Preset value | 00000000 _h |

| | |
|----------------|---------------------|
| Subindex | 03 _h |
| Name | Buffer Organisation |
| Data type | UNSIGNED8 |
| Access | read / write |
| PDO mapping | no |
| Allowed values | |
| Preset value | 00 _h |

| | |
|----------------|-------------------|
| Subindex | 04 _h |
| Name | Buffer Position |
| Data type | UNSIGNED16 |
| Access | read / write |
| PDO mapping | no |
| Allowed values | |
| Preset value | 0000 _h |

| | |
|----------------|---------------------|
| Subindex | 05 _h |
| Name | Size Of Data Record |
| Data type | UNSIGNED8 |
| Access | write only |
| PDO mapping | no |
| Allowed values | |
| Preset value | 01 _h |

| | |
|-----------|-----------------|
| Subindex | 06 _h |
| Name | Buffer Clear |
| Data type | UNSIGNED8 |

| | |
|----------------|-----------------|
| Access | write only |
| PDO mapping | no |
| Allowed values | |
| Preset value | 00 _h |

Description

The value of subindex 01_h contains the maximum possible number of interpolated records.

The value of subindex 02_h contains the current number of interpolated records.

If subindex 03_h is "00_h", this means a FIFO buffer organization; if it is "01_h", it specifies a ring buffer organization.

The value of subindex 04_h is unitless and specifies the next free buffer entry point.

The value of subindex 05_h is specified in units of "byte".

If the value "00_h" is written in subindex 06_h, it deletes the received data in the buffer, deactivates access and deletes all interpolated records.

If the value "01_h" is written in subindex 06_h, it activates access to the input buffer.

60C5h Max Acceleration

Function

This object contains the maximum permissible acceleration for the Profile Position and Profile Velocity modes.

Object description

| | |
|------------------|----------------------------|
| Index | 60C5 _h |
| Object name | Max Acceleration |
| Object Code | VARIABLE |
| Data type | UNSIGNED32 |
| Savable | yes, category: application |
| Access | read / write |
| PDO mapping | RX-PDO |
| Allowed values | |
| Preset value | 00001388 _h |
| Firmware version | FIR-v1426 |
| Change history | |

60C6h Max Deceleration

Function

This object contains the maximum permissible deceleration (deceleration ramp) for the Profile Position, Profile Velocity and Interpolated Position Mode operating modes.

Object description

| | |
|-------------|-------------------|
| Index | 60C6 _h |
| Object name | Max Deceleration |
| Object Code | VARIABLE |

| | |
|------------------|----------------------------|
| Data type | UNSIGNED32 |
| Savable | yes, category: application |
| Access | read / write |
| PDO mapping | RX-PDO |
| Allowed values | |
| Preset value | 00001388 _h |
| Firmware version | FIR-v1426 |
| Change history | |

60E4h Additional Position Actual Value

Function

Contains the current actual position of all existing feedbacks in user-defined units.

Object description

| | |
|------------------|--|
| Index | 60E4 _h |
| Object name | Additional Position Actual Value |
| Object Code | ARRAY |
| Data type | INTEGER32 |
| Savable | no |
| Access | read only |
| PDO mapping | TX-PDO |
| Allowed values | |
| Preset value | |
| Firmware version | FIR-v1738-B501312 |
| Change history | Firmware version FIR-v1748-B538662: "Data type" entry changed from "UNSIGNED32" to "INTEGER32". Firmware version FIR-v1748-B538662: "Data type" entry changed from "UNSIGNED32" to "INTEGER32". |

Value description

| | |
|----------------|-------------------|
| Subindex | 00 _h |
| Name | Number Of Entries |
| Data type | UNSIGNED8 |
| Access | read only |
| PDO mapping | TX-PDO |
| Allowed values | |
| Preset value | 02 _h |

| | |
|-----------|--|
| Subindex | 01 _h - 02 _h |
| Name | Additional Position Actual Value #1 - #2 |
| Data type | INTEGER32 |
| Access | read only |

| | |
|----------------|-----------------------|
| PDO mapping | TX-PDO |
| Allowed values | |
| Preset value | 00000000 _h |

Description

The subindices have the following function:

- 00_h: Value="1" to "n", where "n" is the number of existing feedbacks.
- n_h:
 Subindex n contains the current actual position of the corresponding feedback.
 Subindex 01_h always corresponds to the first (and always existing) *sensorless* feedback.

60E5h Additional Velocity Actual Value

Function

Contains the current actual speed of all existing feedbacks in user-defined units.

Object description

| | |
|------------------|----------------------------------|
| Index | 60E5 _h |
| Object name | Additional Velocity Actual Value |
| Object Code | ARRAY |
| Data type | INTEGER32 |
| Savable | no |
| Access | read only |
| PDO mapping | TX-PDO |
| Allowed values | |
| Preset value | |
| Firmware version | FIR-v1738-B501312 |
| Change history | |

Value description

| | |
|----------------|-------------------|
| Subindex | 00 _h |
| Name | Number Of Entries |
| Data type | UNSIGNED8 |
| Access | read only |
| PDO mapping | TX-PDO |
| Allowed values | |
| Preset value | 02 _h |

| | |
|----------------|--|
| Subindex | 01 _h - 02 _h |
| Name | Additional Velocity Actual Value #1 - #2 |
| Data type | INTEGER32 |
| Access | read only |
| PDO mapping | TX-PDO |
| Allowed values | |

| | |
|--------------|-----------------------|
| Preset value | 00000000 _h |
|--------------|-----------------------|

Description

The subindices have the following function:

- 00_h: Value="1" to "n", where "n" is the number of existing feedbacks.
- n_h:
 Subindex n contains the current actual speed of the corresponding feedback.
 Subindex 01_h always corresponds to the first (and always existing) *sensorless* feedback.

60E6h Additional Position Encoder Resolution - Encoder Increments

Function

With this object and with 60EB_h, the resolution of each existing feedback is calculated.

Object description

| | |
|------------------|---|
| Index | 60E6 _h |
| Object name | Additional Position Encoder Resolution - Encoder Increments |
| Object Code | ARRAY |
| Data type | INTEGER32 |
| Savable | yes, category: tuning |
| Access | read only |
| PDO mapping | RX-PDO |
| Allowed values | |
| Preset value | |
| Firmware version | FIR-v1748-B538662 |
| Change history | |

Value description

| | |
|----------------|-------------------|
| Subindex | 00 _h |
| Name | Number Of Entries |
| Data type | UNSIGNED8 |
| Access | read only |
| PDO mapping | RX-PDO |
| Allowed values | |
| Preset value | 02 _h |

| | |
|----------------|---|
| Subindex | 01 _h - 02 _h |
| Name | Additional Position Encoder Resolution - Encoder Increments Feedback Interface #1 - #2 |
| Data type | INTEGER32 |
| Access | read / write |
| PDO mapping | RX-PDO |
| Allowed values | |
| Preset value | 00000000 _h |

Description

The subindices have the following function:

- 00_h : Value="1" to "n", where "n" is the number of existing feedbacks.
- n_h :
 Subindex n contains the number of increments of the corresponding feedback.
 Subindex 01_h always corresponds to the first (and always existing) *sensorless* feedback.

The resolution of feedback "n" is calculated as follows:

Position Encoder Resolution = Encoder Increments ($60E6_h:01_h$) / Motor Revolutions ($60EB_h:02_h$)

NOTICE



The value "0" in a subindex means that the respective feedback is not connected and is not used. Thus, it is possible, for Example, to switch off the sensorless function to save computing time. This can be helpful if a *NanoJ* program needs the computing time.

If a value is not equal to "0" in a subindex, the controller checks the corresponding sensor when switching on. In case of an error (signal not present, invalid configuration/state), the error bit is set in the statusword and an error code stored in object 1003h.

60E8h Additional Gear Ratio - Motor Shaft Revolutions

Function

In this object and in $60ED_h$, you can set the gear ratio of each existing feedback.

Object description

| | |
|------------------|---|
| Index | $60E8_h$ |
| Object name | Additional Gear Ratio - Motor Shaft Revolutions |
| Object Code | ARRAY |
| Data type | UNSIGNED32 |
| Savable | yes, category: application |
| Access | read only |
| PDO mapping | RX-PDO |
| Allowed values | |
| Preset value | |
| Firmware version | FIR-v1738-B501312 |
| Change history | |

Value description

| | |
|----------------|-------------------|
| Subindex | 00_h |
| Name | Number Of Entries |
| Data type | UNSIGNED8 |
| Access | read only |
| PDO mapping | RX-PDO |
| Allowed values | |
| Preset value | 02_h |

| | |
|----------------|--|
| Subindex | 01 _h - 02 _h |
| Name | Additional Gear Ratio - Motor Shaft Revolutions Feedback Interface #1 - #2 |
| Data type | UNSIGNED32 |
| Access | read / write |
| PDO mapping | RX-PDO |
| Allowed values | |
| Preset value | 00000001 _h |

Description

The subindices have the following function:

- 00_h: Value = "n", where "n" is the number of existing feedbacks.
- n_h: Subindex "n" contains the number of motor revolutions for the corresponding feedback. Subindex 01_h always corresponds to the first (and always existing) *sensorless* feedback.

The gear ratio of feedback "n" is calculated as follows:

Gear Ratio = Motor Shaft Revolutions (60E8_h:n_h) / Driving Shaft Revolutions (60ED_h:n_h)

60E9h Additional Feed Constant - Feed

Function

In this object and in 60EE_h, you can set a feed constant for each existing feedback.

Object description

| | |
|------------------|---------------------------------|
| Index | 60E9 _h |
| Object name | Additional Feed Constant - Feed |
| Object Code | ARRAY |
| Data type | UNSIGNED32 |
| Savable | yes, category: application |
| Access | read only |
| PDO mapping | RX-PDO |
| Allowed values | |
| Preset value | |
| Firmware version | FIR-v1738-B501312 |
| Change history | |

Value description

| | |
|----------------|-------------------|
| Subindex | 00 _h |
| Name | Number Of Entries |
| Data type | UNSIGNED8 |
| Access | read only |
| PDO mapping | RX-PDO |
| Allowed values | |
| Preset value | 02 _h |

| | |
|----------------|--|
| Subindex | 01 _h - 02 _h |
| Name | Additional Feed Constant - Feed Feedback Interface #1 - #2 |
| Data type | UNSIGNED32 |
| Access | read / write |
| PDO mapping | RX-PDO |
| Allowed values | |
| Preset value | 00000001 _h |

Description

The subindices have the following function:

- 00_h: Value = "n", where "n" is the number of existing feedbacks.
- n_h: Subindex "n" contains the feed in user-defined units for the corresponding feedback.
Subindex 01_h always corresponds to the first (and always existing) *sensorless* feedback.

The feed constant of feedback "n" is calculated as follows:

Feed Constant = Feed (60E9_h:n_h) / Driving Shaft Revolutions (60EE_h:n_h)

60EBh Additional Position Encoder Resolution - Motor Revolutions

Function

With this object and with 60E6_h, the resolution of each existing feedback is calculated.

Object description

| | |
|------------------|--|
| Index | 60EB _h |
| Object name | Additional Position Encoder Resolution - Motor Revolutions |
| Object Code | ARRAY |
| Data type | UNSIGNED32 |
| Savable | yes, category: tuning |
| Access | read only |
| PDO mapping | RX-PDO |
| Allowed values | |
| Preset value | |
| Firmware version | FIR-v1738-B501312 |
| Change history | |

Value description

| | |
|----------------|-------------------|
| Subindex | 00 _h |
| Name | Number Of Entries |
| Data type | UNSIGNED8 |
| Access | read only |
| PDO mapping | RX-PDO |
| Allowed values | |
| Preset value | 02 _h |

| | |
|----------------|---|
| Subindex | 01 _h - 02 _h |
| Name | Additional Position Encoder Resolution - Motor Revolutions Feedback Interface #1 - #2 |
| Data type | UNSIGNED32 |
| Access | read / write |
| PDO mapping | RX-PDO |
| Allowed values | |
| Preset value | 00000001 _h |

Description

The subindices have the following function:

- 00_h: Value="1" to "n", where "n" is the number of existing feedbacks.
- n_h:
 Subindex n contains the number of motor revolutions of the corresponding feedback.
 Subindex 01_h always corresponds to the first (and always existing) *sensorless* feedback.

The resolution of feedback "n" is calculated as follows:

Position Encoder Resolution = Encoder Increments (60E6_h:n_h) / Motor Revolutions (60EB_h:n_h)

60EDh Additional Gear Ratio - Driving Shaft Revolutions

Function

In this object and in 60E8_h, you can set the gear ratio of each existing feedback.

Object description

| | |
|------------------|---|
| Index | 60ED _h |
| Object name | Additional Gear Ratio - Driving Shaft Revolutions |
| Object Code | ARRAY |
| Data type | UNSIGNED32 |
| Savable | yes, category: application |
| Access | read only |
| PDO mapping | RX-PDO |
| Allowed values | |
| Preset value | |
| Firmware version | FIR-v1738-B501312 |
| Change history | |

Value description

| | |
|----------------|-------------------|
| Subindex | 00 _h |
| Name | Number Of Entries |
| Data type | UNSIGNED8 |
| Access | read only |
| PDO mapping | RX-PDO |
| Allowed values | |
| Preset value | 02 _h |

| | |
|----------------|--|
| Subindex | 01 _h - 02 _h |
| Name | Additional Gear Ratio - Driving Shaft Revolutions Feedback Interface #1 - #2 |
| Data type | UNSIGNED32 |
| Access | read / write |
| PDO mapping | RX-PDO |
| Allowed values | |
| Preset value | 00000001 _h |

Description

The subindices have the following function:

- 00_h: Value = "n", where "n" is the number of existing feedbacks.
- n_h: Subindex "n" contains the number of revolutions of the output shaft for the corresponding feedback. Subindex 01_h always corresponds to the first (and always existing) *sensorless* feedback.

The gear ratio of feedback "n" is calculated as follows:

Gear Ratio = Motor Shaft Revolutions (60E8_h:n_h) / Driving Shaft Revolutions (60ED_h:n_h)

60EEh Additional Feed Constant - Driving Shaft Revolutions

Function

In this object and in 60E9_h, you can set a feed constant for each existing feedback.

Object description

| | |
|------------------|--|
| Index | 60EE _h |
| Object name | Additional Feed Constant - Driving Shaft Revolutions |
| Object Code | ARRAY |
| Data type | UNSIGNED32 |
| Savable | yes, category: application |
| Access | read only |
| PDO mapping | RX-PDO |
| Allowed values | |
| Preset value | |
| Firmware version | FIR-v1738-B501312 |
| Change history | |

Value description

| | |
|----------------|-------------------|
| Subindex | 00 _h |
| Name | Number Of Entries |
| Data type | UNSIGNED8 |
| Access | read only |
| PDO mapping | RX-PDO |
| Allowed values | |
| Preset value | 02 _h |

| | |
|----------------|---|
| Subindex | 01 _h - 02 _h |
| Name | Additional Feed Constant - Driving Shaft Revolutions Feedback Interface #1 - #2 |
| Data type | UNSIGNED32 |
| Access | read / write |
| PDO mapping | RX-PDO |
| Allowed values | |
| Preset value | 00000001 _h |

Description

The subindices have the following function:

- 00_h: Value = "n", where "n" is the number of existing feedbacks.
- n_h: Subindex "n" contains the number of revolutions of the output shaft for the corresponding feedback. Subindex 01_h always corresponds to the first (and always existing) *sensorless* feedback.

The feed constant of feedback "n" is calculated as follows:

Feed Constant = Feed (60E9_h:n_h) / Driving Shaft Revolutions (60EE_h:n_h)

60F2h Position Option Code

Function

The object describes the positioning behavior in Profile Position mode.

Object description

| | |
|------------------|---|
| Index | 60F2 _h |
| Object name | Position Option Code |
| Object Code | VARIABLE |
| Data type | UNSIGNED16 |
| Savable | yes, category: application |
| Access | read / write |
| PDO mapping | RX-PDO |
| Allowed values | |
| Preset value | 0000 _h |
| Firmware version | FIR-v1446 |
| Change history | <p>Firmware version FIR-v1614: "Savable" entry changed from "no" to "yes, category: application".</p> <p>Firmware version FIR-v2412-B1057638: entry "Object Name" changed from "Positioning Option Code" to "Position Option Code".</p> |

Description

Only the following bits are supported at the present time:

| | | | | | | | | | | | | | | | |
|----|--------------|----|----|---------------|----|---|----------|---|---------|---|---------|---|---------------|---|---|
| 15 | 14 | 13 | 12 | 11 | 10 | 9 | 8 | 7 | 6 | 5 | 4 | 3 | 2 | 1 | 0 |
| MS | RESERVED [3] | | | IP OPTION [4] | | | RADO [2] | | RRO [2] | | CIO [2] | | REL. OPT. [2] | | |

REL. OPT. (Relative Option)

These bits determine the behavior with relative rotating movement in "profile position" mode if bit 6 of controlword 6040_h = "1" is set.

| Bit 1 | Bit 0 | Definition |
|-------|-------|---|
| 0 | 0 | Position movements are executed relative to the previous (internal absolute) target position (each relative to 0 if there is no previous target position) |
| 0 | 1 | Position movements are executed relative to the preset value (or output) of the ramp generator. |
| 1 | 0 | Position movements are performed relative to the current position (object 6064_h). |
| 1 | 1 | Reserved |

RRO (Request-Response Option)

These bits determine the behavior when passing controlword 6040_h bit 4 ("new setpoint") – in this case, the controller releases the bit itself. This eliminates the need to externally reset the bit to "0" afterwards. After the bit is set to the value "0" by the controller, bit 12 ("setpoint acknowledgment") is also set to the value "0" in statusword 6041_h .



NOTICE

These options cause the controller to modify object controlword 6040_h .

| Bit 5 | Bit 4 | Definition |
|-------|-------|---|
| 0 | 0 | The functionality is as described under Setting travel commands . |
| 0 | 1 | The controller releases the "new setpoint" bit as soon as the current targeted movement has reached its target. |
| 1 | 0 | The controller releases the "new setpoint" bit as soon as this is possible for the controller. |
| 1 | 1 | Reserved |

RADO (Rotary Axis Direction Option)

These bits determine the direction of rotation in "profile position" mode.

| Bit 7 | Bit 6 | Definition |
|-------|-------|---|
| 0 | 0 | Normal positioning similar to a linear axis: If one of the "Position Range Limits" – $607B_h:01_h$ and 02_h – is reached or exceeded, the preset is automatically transferred to the other end of the limit. Only with this bit combination is a movement greater than the modulo value possible. |
| 0 | 1 | Positioning only in negative direction: If the target position is greater than the current position, the axis moves to the target position via the "Min Position Range Limit" from object $607D_h:01_h$. |
| 1 | 0 | Positioning only in positive direction: If the target position is less than the current position, the axis moves to the target position via the "Max Position Range Limit" from object $607D_h:01_h$. |

| Bit 7 | Bit 6 | Definition |
|-------|-------|---|
| 1 | 1 | Positioning with the shortest distance to the target position. If the difference between the current position and the target position in a 360° system is less than 180°, the axis moves in the positive direction. |

60F4h Following Error Actual Value

Function

This object contains the current following error in user-defined units.

Object description

| | |
|------------------|------------------------------|
| Index | 60F4 _h |
| Object name | Following Error Actual Value |
| Object Code | VARIABLE |
| Data type | INTEGER32 |
| Savable | no |
| Access | read only |
| PDO mapping | TX-PDO |
| Allowed values | |
| Preset value | 00000000 _h |
| Firmware version | FIR-v1426 |
| Change history | |

60F8h Max Slippage

Function

Defines the maximum allowed slippage error in user-defined units symmetrically to the set speed in Profile Velocity mode.

Object description

| | |
|------------------|----------------------------|
| Index | 60F8 _h |
| Object name | Max Slippage |
| Object Code | VARIABLE |
| Data type | INTEGER32 |
| Savable | yes, category: application |
| Access | read / write |
| PDO mapping | RX-PDO |
| Allowed values | |
| Preset value | 00000190 _h |
| Firmware version | FIR-v1738-B501312 |
| Change history | |

Description

If the actual speed deviates so much from the set speed that the value (absolute value) of this object is exceeded, bit 13 in object `6041h` is set. The deviation must last longer than the time in object `203Fh`.

If the value of `60F8h` is set to "7FFFFFFF"_h, slippage error monitoring is switched off.

A reaction to the slippage error can be set in object `3700h`. If a reaction is defined, an error is also entered in object `1003h`.

60FA_h Control Effort

Function

This object contains the correction speed (control variable) in user-defined units that is fed to the velocity controller by the position controller.

Object description

| | |
|------------------|-----------------------|
| Index | 60FA _h |
| Object name | Control Effort |
| Object Code | VARIABLE |
| Data type | INTEGER32 |
| Savable | no |
| Access | read only |
| PDO mapping | TX-PDO |
| Allowed values | |
| Preset value | 00000000 _h |
| Firmware version | FIR-v1748-B531667 |
| Change history | |

Description

The position controller calculates a correction speed (in user-defined units) from the difference between the current position and the demand position which is then passed on to the velocity controller. This correction value is dependent on the proportional component and integral component of the position controller. See also chapter [Closed-Loop](#).

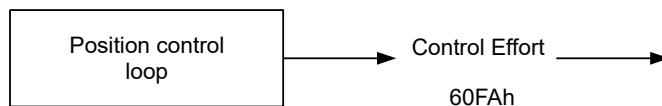

60FC_h Position Demand Internal Value

Function

Object description

| | |
|-------|-------------------|
| Index | 60FC _h |
|-------|-------------------|

| | |
|------------------|--------------------------------|
| Object name | Position Demand Internal Value |
| Object Code | VARIABLE |
| Data type | INTEGER32 |
| Savable | no |
| Access | read only |
| PDO mapping | TX-PDO |
| Allowed values | |
| Preset value | 00000000 _h |
| Firmware version | FIR-v1738-B501312 |
| Change history | |

60FDh Digital Inputs

Function

With this object, the digital inputs of the motor can be read.

Object description

| | |
|------------------|-----------------------|
| Index | 60FD _h |
| Object name | Digital Inputs |
| Object Code | VARIABLE |
| Data type | UNSIGNED32 |
| Savable | no |
| Access | read only |
| PDO mapping | TX-PDO |
| Allowed values | |
| Preset value | 00000000 _h |
| Firmware version | FIR-v1426 |
| Change history | |

Description

| | | | | | | | | | | | | | | | |
|----|----|----|----|----|----|----|-----|------|------|------|------|------|------|------|------|
| 31 | 30 | 29 | 28 | 27 | 26 | 25 | 24 | 23 | 22 | 21 | 20 | 19 | 18 | 17 | 16 |
| | | | | | | | ... | IN 7 | IN 6 | IN 5 | IN 4 | IN 3 | IN 2 | IN 1 | IN 0 |
| 15 | 14 | 13 | 12 | 11 | 10 | 9 | 8 | 7 | 6 | 5 | 4 | 3 | 2 | 1 | 0 |
| | | | | | | | | | | | | IL | HS | PLS | NLS |

NLS (Negative Limit Switch)

Negative limit switch

PLS (Positive Limit Switch)

Positive limit switch

HS (Home Switch)

Home switch

IL (Interlock)

Interlock

IN n (Input n)

Input n – the number of used bits is dependent on the given controller.

60FEh Digital Outputs**Function**

With this object, the digital outputs of the motor can be written.

Object description

| | |
|------------------|--|
| Index | 60FE _h |
| Object name | Digital Outputs |
| Object Code | ARRAY |
| Data type | UNSIGNED32 |
| Savable | yes, category: application |
| Firmware version | FIR-v1426 |
| Change history | Firmware version FIR-v1626: "Savable" entry changed from "no" to "yes, category: application". |

Value description

| | |
|----------------|-------------------|
| Subindex | 00 _h |
| Name | Number Of Entries |
| Data type | UNSIGNED8 |
| Access | read only |
| PDO mapping | no |
| Allowed values | |
| Preset value | 01 _h |

| | |
|----------------|-----------------------|
| Subindex | 01 _h |
| Name | Physical Outputs |
| Data type | UNSIGNED32 |
| Access | read / write |
| PDO mapping | RX-PDO |
| Allowed values | |
| Preset value | 00000000 _h |

Description

To write the outputs, the entries in object 3250_h, subindex 02_h to 05_h, must also be taken into account.

| | | | | | | | | | | | | | | | |
|----|----|----|----|----|----|----|----|----|----|----|-----|------|------|------|------|
| 31 | 30 | 29 | 28 | 27 | 26 | 25 | 24 | 23 | 22 | 21 | 20 | 19 | 18 | 17 | 16 |
| | | | | | | | | | | | ... | OUT4 | OUT3 | OUT2 | OUT1 |
| 15 | 14 | 13 | 12 | 11 | 10 | 9 | 8 | 7 | 6 | 5 | 4 | 3 | 2 | 1 | 0 |
| | | | | | | | | | | | | | | | BRK |

BRK (Brake)

Bit for the brake output (if the controller supports this function):

Value "1" means that the brake is activated (no current can flow between the two pins of the brake connection; the brake is closed).

OUT n (Output No n)

Bit for the respective digital output; the exact number of digital outputs is dependent on the controller.

60FFh Target Velocity**Function**

In this object, the target speed for the profile velocity and cyclic synchronous velocity modes is entered in user-defined units.

Object description

| | |
|------------------|--|
| Index | 60FF _h |
| Object name | Target Velocity |
| Object Code | VARIABLE |
| Data type | INTEGER32 |
| Savable | yes, category: application |
| Access | read / write |
| PDO mapping | RX-PDO |
| Allowed values | |
| Preset value | 00000000 _h |
| Firmware version | FIR-v1426 |
| Change history | Firmware version FIR-v1626: "Savable" entry changed from "no" to "yes, category: application". |

6502h Supported Drive Modes**Function**

The object describes the supported operating modes in object 6060_h.

Object description

| | |
|------------------|-----------------------|
| Index | 6502 _h |
| Object name | Supported Drive Modes |
| Object Code | VARIABLE |
| Data type | UNSIGNED32 |
| Savable | no |
| Access | read only |
| PDO mapping | TX-PDO |
| Allowed values | |
| Preset value | 000003EF _h |
| Firmware version | FIR-v1426 |

Change history

Description

The set bit specifies whether the respective mode is supported. If the value of the bit is "0", the mode is not supported.

| | | | | | | | | | | | | | | | |
|----|----|----|----|----|----|-----|-----|-----|----|----|----|----|----|----|----|
| 31 | 30 | 29 | 28 | 27 | 26 | 25 | 24 | 23 | 22 | 21 | 20 | 19 | 18 | 17 | 16 |
| | | | | | | | | | | | | | | | |
| 15 | 14 | 13 | 12 | 11 | 10 | 9 | 8 | 7 | 6 | 5 | 4 | 3 | 2 | 1 | 0 |
| | | | | | | CST | CSV | CSP | IP | HM | | TQ | PV | VL | PP |

PP

Profile Position Mode

VL

Velocity Mode

PV

Profile Velocity Mode

TQ

Torque Mode

HM

Homing Mode

IP

Interpolated Position Mode

CSP

Cyclic Synchronous Position Mode

CSV

Cyclic Synchronous Velocity Mode

CST

Cyclic Synchronous Torque Mode

6503h Drive Catalogue Number

Function

Contains the device name as character string.

Object description

| | |
|-------------|------------------------|
| Index | 6503 _h |
| Object name | Drive Catalogue Number |
| Object Code | VARIABLE |
| Data type | VISIBLE_STRING |
| Savable | no |
| Access | read only |
| PDO mapping | no |

| | |
|------------------|-----------|
| Allowed values | |
| Preset value | 0 |
| Firmware version | FIR-v1426 |
| Change history | |

6505h Http Drive Catalogue Address

Function

This object contains the manufacturer's web address as a character string.

Object description

| | |
|------------------|------------------------------|
| Index | 6505 _h |
| Object name | Http Drive Catalogue Address |
| Object Code | VARIABLE |
| Data type | VISIBLE_STRING |
| Savable | no |
| Access | read only |
| PDO mapping | no |
| Allowed values | |
| Preset value | 0 |
| Firmware version | FIR-v1426 |
| Change history | |

11 Copyrights

11.1 Introduction

Integrated in the Nanotec software are components from products from external software manufacturers. In this chapter, you will find the copyright information regarding the used external software sources.

11.2 AES

FIPS-197 compliant AES implementation

Based on XySSL: Copyright (C) 2006-2008 Christophe Devine

Copyright (C) 2009 Paul Bakker <polarssl_maintainer at polarssl dot org>

All rights reserved.

Redistribution and use in source and binary forms, with or without modification, are permitted provided that the following conditions are met:

- Redistributions of source code must retain the above copyright notice, this list of conditions and the following disclaimer.
- Redistributions in binary form must reproduce the above copyright notice, this list of conditions and the following disclaimer in the documentation and/or other materials provided with the distribution; or, the application vendor's website must provide a copy of this notice.
- Neither the names of PolarSSL or XySSL nor the names of its contributors may be used to endorse or promote products derived from this software without specific prior written permission.

THIS SOFTWARE IS PROVIDED BY THE COPYRIGHT HOLDERS AND CONTRIBUTORS "AS IS" AND ANY EXPRESS OR IMPLIED WARRANTIES, INCLUDING, BUT NOT LIMITED TO, THE IMPLIED WARRANTIES OF MERCHANTABILITY AND FITNESS FOR A PARTICULAR PURPOSE ARE DISCLAIMED. IN NO EVENT SHALL THE COPYRIGHT OWNER OR CONTRIBUTORS BE LIABLE FOR ANY DIRECT, INDIRECT, INCIDENTAL, SPECIAL, EXEMPLARY, OR CONSEQUENTIAL DAMAGES (INCLUDING, BUT NOT LIMITED TO, PROCUREMENT OF SUBSTITUTE GOODS OR SERVICES; LOSS OF USE, DATA, OR PROFITS; OR BUSINESS INTERRUPTION) HOWEVER CAUSED AND ON ANY THEORY OF LIABILITY, WHETHER IN CONTRACT, STRICT LIABILITY, OR TORT (INCLUDING NEGLIGENCE OR OTHERWISE) ARISING IN ANY WAY OUT OF THE USE OF THIS SOFTWARE, EVEN IF ADVISED OF THE POSSIBILITY OF SUCH DAMAGE.

The AES block cipher was designed by Vincent Rijmen and Joan Daemen.

<http://csrc.nist.gov/encryption/aes/rijndael/Rijndael.pdf>

<http://csrc.nist.gov/publications/fips/fips197/fips-197.pdf>

11.3 MD5

MD5C.C - RSA Data Security, Inc., MD5 message-digest algorithm

Copyright (C) 1991-2, RSA Data Security, Inc. Created 1991. All rights reserved.

License to copy and use this software is granted provided that it is identified as the "RSA Data Security, Inc. MD5 Message-Digest Algorithm" in all material mentioning or referencing this software or this function.

License is also granted to make and use derivative works provided that such works are identified as "derived from the RSA Data Security, Inc. MD5 Message-Digest Algorithm" in all material mentioning or referencing the derived work.

RSA Data Security, Inc. makes no representations concerning either the merchantability of this software or the suitability of this software for any particular purpose. It is provided "as is" without express or implied warranty of any kind.

These notices must be retained in any copies of any part of this documentation and/or software.

11.4 uIP

Copyright (c) 2005, Swedish Institute of Computer Science

All rights reserved.

Redistribution and use in source and binary forms, with or without modification, are permitted provided that the following conditions are met:

1. Redistributions of source code must retain the above copyright notice, this list of conditions and the following disclaimer.
2. Redistributions in binary form must reproduce the above copyright notice, this list of conditions and the following disclaimer in the documentation and/or other materials provided with the distribution.
3. Neither the name of the Institute nor the names of its contributors may be used to endorse or promote products derived from this software without specific prior written permission.

THIS SOFTWARE IS PROVIDED BY THE INSTITUTE AND CONTRIBUTORS ``AS IS" AND ANY EXPRESS OR IMPLIED WARRANTIES, INCLUDING, BUT NOT LIMITED TO, THE IMPLIED WARRANTIES OF MERCHANTABILITY AND FITNESS FOR A PARTICULAR PURPOSE ARE DISCLAIMED. IN NO EVENT SHALL THE INSTITUTE OR CONTRIBUTORS BE LIABLE FOR ANY DIRECT, INDIRECT, INCIDENTAL, SPECIAL, EXEMPLARY, OR CONSEQUENTIAL DAMAGES (INCLUDING, BUT NOT LIMITED TO, PROCUREMENT OF SUBSTITUTE GOODS OR SERVICES; LOSS OF USE, DATA, OR PROFITS; OR BUSINESS INTERRUPTION) HOWEVER CAUSED AND ON ANY THEORY OF LIABILITY, WHETHER IN CONTRACT, STRICT LIABILITY, OR TORT (INCLUDING NEGLIGENCE OR OTHERWISE) ARISING IN ANY WAY OUT OF THE USE OF THIS SOFTWARE, EVEN IF ADVISED OF THE POSSIBILITY OF SUCH DAMAGE.

11.5 DHCP

Copyright (c) 2005, Swedish Institute of Computer Science

All rights reserved.

Redistribution and use in source and binary forms, with or without modification, are permitted provided that the following conditions are met:

1. Redistributions of source code must retain the above copyright notice, this list of conditions and the following disclaimer.
2. Redistributions in binary form must reproduce the above copyright notice, this list of conditions and the following disclaimer in the documentation and/or other materials provided with the distribution.
3. Neither the name of the Institute nor the names of its contributors may be used to endorse or promote products derived from this software without specific prior written permission.

THIS SOFTWARE IS PROVIDED BY THE INSTITUTE AND CONTRIBUTORS ``AS IS" AND ANY EXPRESS OR IMPLIED WARRANTIES, INCLUDING, BUT NOT LIMITED TO, THE IMPLIED WARRANTIES OF MERCHANTABILITY AND FITNESS FOR A PARTICULAR PURPOSE ARE DISCLAIMED. IN NO EVENT SHALL THE INSTITUTE OR CONTRIBUTORS BE LIABLE FOR ANY DIRECT, INDIRECT, INCIDENTAL, SPECIAL, EXEMPLARY, OR CONSEQUENTIAL DAMAGES (INCLUDING, BUT NOT LIMITED TO, PROCUREMENT OF SUBSTITUTE GOODS OR SERVICES; LOSS OF USE, DATA, OR PROFITS; OR BUSINESS INTERRUPTION) HOWEVER CAUSED AND ON ANY THEORY OF LIABILITY, WHETHER IN CONTRACT, STRICT LIABILITY, OR TORT (INCLUDING NEGLIGENCE OR OTHERWISE) ARISING IN ANY WAY OUT OF THE USE OF THIS SOFTWARE, EVEN IF ADVISED OF THE POSSIBILITY OF SUCH DAMAGE.

11.6 CMSIS DSP Software Library

Copyright (C) 2010 ARM Limited. All rights reserved.

11.7 FatFs

FatFs - FAT file system module include file R0.08 (C)ChaN, 2010

FatFs module is a generic FAT file system module for small embedded systems.

This is a free software that opened for education, research and commercial developments under license policy of following terms.

Copyright (C) 2010, ChaN, all right reserved.

The FatFs module is a free software and there is NO WARRANTY.

No restriction on use. You can use, modify and redistribute it for personal, non-profit or commercial product UNDER YOUR RESPONSIBILITY.

Redistributions of source code must retain the above copyright notice.

11.8 Protothreads

Protothread class and macros for lightweight, stackless threads in C++.

This was "ported" to C++ from Adam Dunkels' protothreads C library at: <http://www.sics.se/~adam/pt/>

Originally ported for use by Hamilton Jet (www.hamiltonjet.co.nz) by Ben Hoyt, but stripped down for public release. See his blog entry about it for more information: <http://blog.micropledge.com/2008/07/protothreads/>

Original BSD-style license

Copyright (c) 2004-2005, Swedish Institute of Computer Science.

All rights reserved.

Redistribution and use in source and binary forms, with or without modification, are permitted provided that the following conditions are met:

1. Redistributions of source code must retain the above copyright notice, this list of conditions and the following disclaimer.
2. Redistributions in binary form must reproduce the above copyright notice, this list of conditions and the following disclaimer in the documentation and/or other materials provided with the distribution.
3. Neither the name of the Institute nor the names of its contributors may be used to endorse or promote products derived from this software without specific prior written permission.

This software is provided by the Institute and contributors "as is" and any express or implied warranties, including, but not limited to, the implied warranties of merchantability and fitness for a particular purpose are disclaimed. In no event shall the Institute or contributors be liable for any direct, indirect, incidental, special, exemplary, or consequential damages (including, but not limited to, procurement of substitute goods or services; loss of use, data, or profits; or business interruption) however caused and on any theory of liability, whether in contract, strict liability, or tort (including negligence or otherwise) arising in any way out of the use of this software, even if advised of the possibility of such damage.

11.9 lwIP

Copyright (c) 2001-2004 Swedish Institute of Computer Science.

All rights reserved.

Redistribution and use in source and binary forms, with or without modification, are permitted provided that the following conditions are met:

1. Redistributions of source code must retain the above copyright notice, this list of conditions and the following disclaimer.
2. Redistributions in binary form must reproduce the above copyright notice, this list of conditions and the following disclaimer in the documentation and/or other materials provided with the distribution.
3. The name of the author may not be used to endorse or promote products derived from this software without specific prior written permission.

THIS SOFTWARE IS PROVIDED BY THE AUTHOR ``AS IS" AND ANY EXPRESS OR IMPLIED WARRANTIES, INCLUDING, BUT NOT LIMITED TO, THE IMPLIED WARRANTIES OF MERCHANTABILITY AND FITNESS FOR A PARTICULAR PURPOSE ARE DISCLAIMED. IN NO

EVENT SHALL THE AUTHOR BE LIABLE FOR ANY DIRECT, INDIRECT, INCIDENTAL, SPECIAL, EXEMPLARY, OR CONSEQUENTIAL DAMAGES (INCLUDING, BUT NOT LIMITED TO, PROCUREMENT OF SUBSTITUTE GOODS OR SERVICES; LOSS OF USE, DATA, OR PROFITS; OR BUSINESS INTERRUPTION) HOWEVER CAUSED AND ON ANY THEORY OF LIABILITY, WHETHER IN CONTRACT, STRICT LIABILITY, OR TORT (INCLUDING NEGLIGENCE OR OTHERWISE) ARISING IN ANY WAY OUT OF THE USE OF THIS SOFTWARE, EVEN IF ADVISED OF THE POSSIBILITY OF SUCH DAMAGE.

This file is part of the lwIP TCP/IP stack.

Author: Adam Dunkels <adam@sics.se>

11.10 littlefs

```
/*  
 * The little filesystem  
 *  
 * Copyright (c) 2017, Arm Limited. All rights reserved.  
 * SPDX-License-Identifier: BSD-3-Clause  
 */
```

Copyright (c) 2017, Arm Limited. All rights reserved.

- Redistribution and use in source and binary forms, with or without modification, are permitted provided that the following conditions are met:
- Redistributions of source code must retain the above copyright notice, this list of conditions and the following disclaimer.
- Redistributions in binary form must reproduce the above copyright notice, this list of conditions and the following disclaimer in the documentation and/or other materials provided with the distribution.
- Neither the name of ARM nor the names of its contributors may be used to endorse or promote products derived from this software without specific prior written permission.

THIS SOFTWARE IS PROVIDED BY THE COPYRIGHT HOLDERS AND CONTRIBUTORS "AS IS" AND ANY EXPRESS OR IMPLIED WARRANTIES, INCLUDING, BUT NOT LIMITED TO, THE IMPLIED WARRANTIES OF MERCHANTABILITY AND FITNESS FOR A PARTICULAR PURPOSE ARE DISCLAIMED. IN NO EVENT SHALL THE COPYRIGHT HOLDER OR CONTRIBUTORS BE LIABLE FOR ANY DIRECT, INDIRECT, INCIDENTAL, SPECIAL, EXEMPLARY, OR CONSEQUENTIAL DAMAGES (INCLUDING, BUT NOT LIMITED TO, PROCUREMENT OF SUBSTITUTE GOODS OR SERVICES; LOSS OF USE, DATA, OR PROFITS; OR BUSINESS INTERRUPTION) HOWEVER CAUSED AND ON ANY THEORY OF LIABILITY, WHETHER IN CONTRACT, STRICT LIABILITY, OR TORT (INCLUDING NEGLIGENCE OR OTHERWISE) ARISING IN ANY WAY OUT OF THE USE OF THIS SOFTWARE, EVEN IF ADVISED OF THE POSSIBILITY OF SUCH DAMAGE.